



aerospace
climate control
electromechanical
filtration
fluid & gas handling
hydraulics
pneumatics
process control
sealing & shielding



Hydraulic Hose, Fittings and Equipment

Catalogue



ENGINEERING YOUR SUCCESS.

Parker is the global leader

in motion and control technologies, partnering with its customers to increase their productivity and profitability

Parker Hose Products Division, established in 1948, is both a pioneer and market leader in the hose business.

With its history of success as a world leader in the flexible rubber hose market, Parker now more than ever continues to pursue aggressively new technologies and business, and because of this, offers its customers the best solution for each and every hose application.

Hose Products Division has built strong relationships at the OEM and aftermarket levels, tailoring its products and services to the special requirements of both markets.

Parker's goal is constant success. Cooperation with our customers brings about confidence and reliability, mutual respect, open communication and prompt and problem-solving responses.

Hose Products Division Europe has its headquarters in Veniano, Italy, and can supply the hoses and services you need for your particular business.

A Customer-Centric Division

Hose Products Division Europe is a customer-centric division, serving selected European markets with hydraulic and industrial hose products and services.

By maximising value for our customers through quality and service, we can contribute to their and our own long-term profitability. As an easy-to-deal-with organization, we see the empowerment of everyone involved as the key success factor in remaining the preferred source for our markets.





Hydraulic Hoses

Low pressure, medium pressure and high pressure braided and spiral hoses

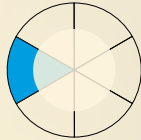
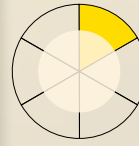

Industrial Hoses

Long length hoses, mandrel-made hoses and PVC hoses ideal for transporting fluids



Hydraulic Fittings

Permanent crimp fittings and re-usable fittings

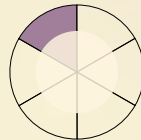
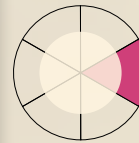

Hose and Tube Assemblies

Hose assemblies, rigid tubes, hose/tube combinations, Tech Services, Kanban, Kitting

Mining Products

Mining hoses, adaptors, valves, filters, pipelines, couplings, manifolds

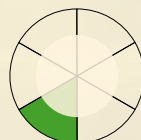

Rubber Compounds

Standard compounds and customer specific formulations. All compounds available in black and coloured

If it moves ...

... we probably have hose products in it or on it.

**Whatever hose application you have,
Hose Products Division Europe has the best solution.**

Market segments for hydraulic hoses:

- Construction
- Transportation
- Agriculture
- Forestry
- Materials Handling
- Automotive / Machine Tool
- Aerospace
- Injection Moulding
- Pulp and Paper
- Marine / Boat
- Power Generation and Energy



Parker Hose Products Division

– a market leader in the hose business

Parker provides proven leak-free fluid conveying systems around the globe and has the power to support them!

-
- **Low Pressure Push-Lok** –
the intelligent solution for low pressure systems and markets
 - **Low Pressure Speciality** –
for extraordinary applications with compressed air, high temperatures, refrigeration, air conditioning and air brake systems
-
- **Medium Pressure Hydraulic**
with *Elite No-Skive* Compact hoses and the classical *No-Skive* hoses – the right products for the present and the future
-
- **High Pressure Hydraulic** –
for heavy duty applications such as in construction, forestry, agriculture, mining and articulated equipment
-
- **Assembly Machines / Accessory Products** –
the perfect complement for the largest range of hose and fittings in the market. Parker crimping technology is recognised throughout industry as the easiest and most accurate crimping system available.
-

We supply a high standard of customer services by focussing on customer needs

The Rapid Service Unit (RSU) – for special hose fittings not included in the standard range

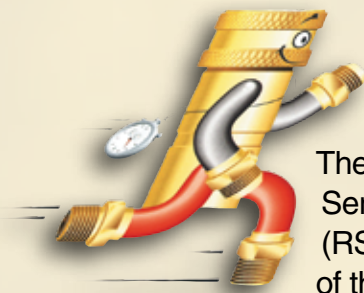

The Rapid Service Unit (RSU) is part of the Manufacturing Unit Fittings of Hose Products Division Europe and is a dedicated unit for the manufacture of customised and prototyp hose fittings. The unit is responsible for both checking the technical possibilities of the customer request,

from an engineering perspective as well as establishing the most economic production process. Because of close cooperation between Parker's Manufacturing Units and the Parker Sales Companies (PSC) the Rapid Service Unit (RSU) can live up to its name by reacting, quoting and supplying rapidly. After receiving the order, the RSU team will promptly



and carefully process the order – from its receipt to the shipping of the fittings. For the production of such fittings, we have dedicated resources in a state-of-the-art manufacturing cell with CNC machinery and tools.

Hose & Tube Assembly Unit (HTA) – provides first class hydraulic and industrial hose assemblies

- Low, medium and high pressure hydraulic hose assemblies with a broad variety of end-configurations
- Combined hose/tube assemblies for hydraulics and mobile air-conditioning applications
- Manipulated steel, stainless steel, aluminium and copper tubes with a broad variety of brazed, welded, formed and pre-assembled end-configurations
- Industrial hose assemblies
- Special hose assemblies for fluid applications in the sport car business



All hose and tube assemblies meet or exceed international standards and the specifications of international OEMs. The Hose and Tube Assembly Unit offers premium customer service in terms of engineering and design support, products, quality and logistic solutions.

We offer more than just innovative products and solutions

Training in Hose Products

The extensive training programme of the Hose Products Division Europe contains theoretical and practical training sessions. Training takes place on a regular basis in the different Parker locations. Beside standard training Parker offers the possibility for customized in-house-training.

The main goal of Parkers product training is to acquire special knowledge about hose products, fittings, connectors and catalogues and will enable you to select efficiently and handle safely all Parker hose products.



For further information about Hose Products Division Europe, please visit our website www.parker.com/euro_hpd and for further information about other Parker products, please call the European Product Information Centre free of charge on **0800 27 27 5374**

Promotion Material about Parker Hose Products

If interested in the promotion material about Parker Hose Products, please contact the relevant Parker Service Centre or visit the website www.parker.com/euro_hpd

Under the menu item „Division Literature“ a library containing the current catalogues, bulletins, technical information etc. can be found.

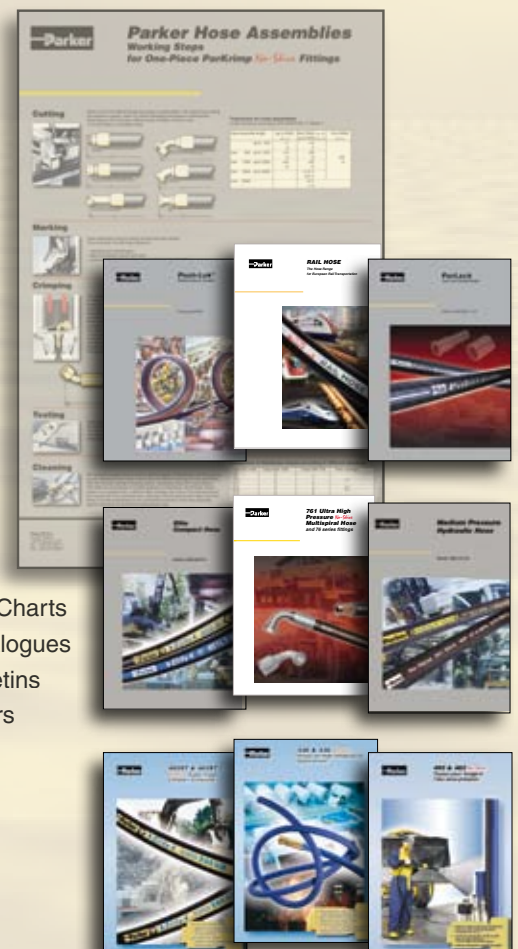

WallCharts
Catalogues
Bulletins
Flyers

Value Added Services

ParkerStore – Total Hose and Fittings Service



The first self-service shop for hydraulic and pneumatic solutions offers

- A huge range of items on stock
- Immediate, on site hose make-up
- The ParkerStore experts are trained and certified by Parker, they are always available to help and to offer the best solutions

HOSE DOCTOR® – Emergency Hose Repair and Replacement Service



HOSE DOCTOR®s are manned by fully trained technicians and are backed up by Parker's wealth of hydraulic expertise. HOSE DOCTOR® helps you reduce your downtime, keeping operating costs to a minimum.

Parker® Tracking System – unique like a fingerprint



The Parker® Tracking System is the quickest way to get high quality hose assemblies

- Fast, accurate and safe identification of the hose assembly
- Unique like a fingerprint
- 8 digit Parker® Tracking System code allows full traceability
- A long-lasting label is applied to each product sold, linking ParkerStores and customers worldwide

**If a replacement hose assembly is required ...
... just call your local ParkerStore!**

- For details of your nearest ParkerStore contact **00800 2727 5374** service number or **+44 (0) 1442 358 429** or visit our website **www.parker.com/pts**
- State where you are and read off the 8 digit Parker® Tracking System code
- The ParkerStore will supply the replacement hose assembly, **whenever - wherever**

ParkerStore Container Service



The ParkerStore container is a transportable workshop, providing on-site maintenance and product support for large construction projects such as roadworks, tunnels, railways, underground systems, etc. Providing an on-site product and hose replacement service. With this service on your site, you can reduce your downtime keeping your project on time and on budget !

Technical Services



With this service, Parker offers customers a true partnership:

- Parker engineers study together with the manufacturer the system and establish an optimized design
- They work on site, with the customer
- They are present from concept through to installation and take charge of the training of operators



Kitting – Personalised Orders



When connectors and related accessories are required on a regular basis for a manufacturing activity, Parker can supply all the necessary items under one order number.

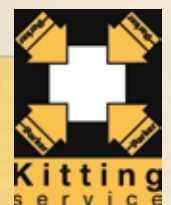

Breadman



This service entails the delivery of products or Parker kits directly to the manufacturer's assembly line, work station or warehouse. This service can be provided by Parker Certified Distributors or by Parker. Advantages for the customer: stocks are reduced, just-in-time delivery, less handling, no more stock-outs.

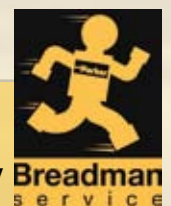

- **Technical Handbook**

- **Low Pressure Push-Lok**

- **Low Pressure Speciality**

- **Medium Pressure Hydraulic**

- **High Pressure Hydraulic**

- **Assembly Machines/Accessory Products**



aerospace
climate control
electromechanical
filtration
fluid & gas handling
hydraulics
pneumatics
process control
sealing & shielding



Hydraulic Hose, Fittings and Equipment

Technical Handbook



ENGINEERING YOUR SUCCESS.

Technology

Today's hose and fitting technology must meet the constantly increasing challenges and requirements of modern machines and equipment in demanding applications and arduous environments.

To satisfy these needs, Parker is continuously developing new state-of-the-art products and technologies.

Parkrimp *No-Skive* Technology – the safe connection

Hose fittings have an impact on the overall efficiency and safety of a hydraulic system.

The *No-Skive* concept was launched by Parker Hannifin some 30 years ago but continual development and the use of modern materials and production techniques have resulted in a state-of-the-art hose to fitting connector.

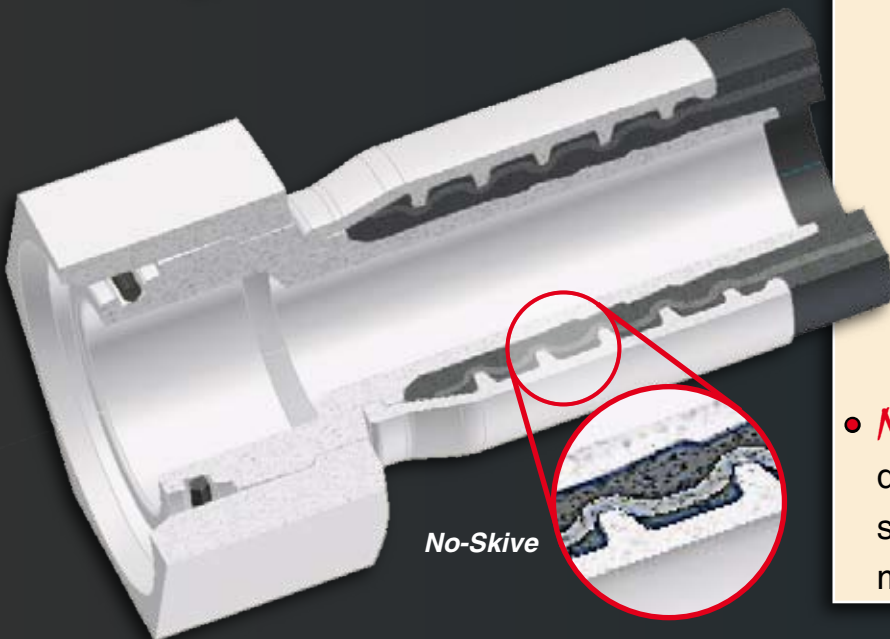
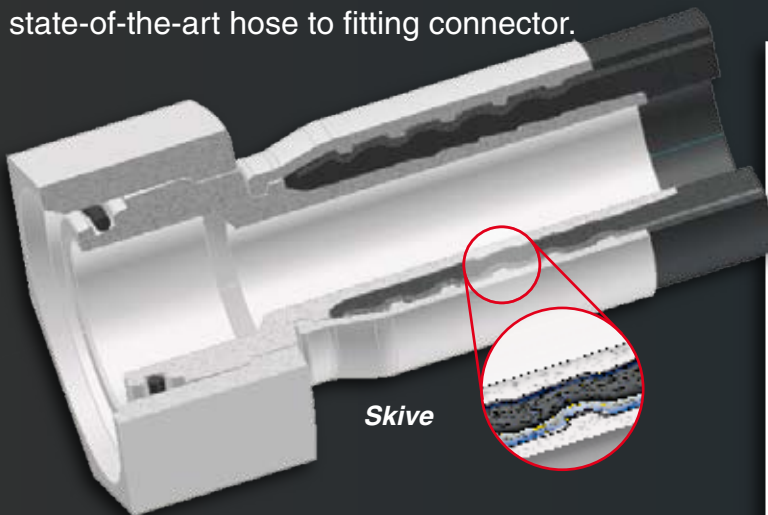

***No-Skive* versus Traditional Skive Fittings**

- Assembly of *No-Skive* hose and Cr(VI)-free fittings does not require removal of the outer cover of the hose:
 - Premature hose failure caused by under or over skiving is avoided.
 - The steel wire reinforcement is protected against corrosion.
 - The steel wire reinforcement is mechanically protected during hose fitting assembly by the outer rubber cover.
- *No-Skive* Cr(VI)-free fittings are designed so that the teeth of the shell bite down to the wire to give a metal-to-metal grip.

Parker Hose Products Division defines the power-grip connection between the crimp fitting and the hydraulic hose as the critical zone in all flexible hose connections. Correct combination of Parker *No-Skive* hose and fittings guarantees a total form lock connection between shell and reinforcement and assures a safe and leak free long service life.

Environmentally Friendly Plating Process



Since 1st July 2007 the EU End-of-life Vehicle Directive (ELV) came into force. European Community Directive 2000/53/EG of 1st July 2002

- Directive manages vehicle recycling
- Prohibition on the use of chromium-6, mercury and lead with specified exceptions and the prohibition of cadmium
- Metallic chromium and chromium-3 compounds may still be used

Chromium-6 has been classified in the EU Directive 67/548/EWG as Category 2, which means that this material can under certain circumstances act as a carcinogenic. Skin contact can bring about allergic reactions. Since 2006, all Parker steel fittings have been manufactured using trivalent chromate (Chromium-6-Free) plating. This new process enhances the corrosion resistance of the fittings, and is more environmentally friendly than the previous hexavalent chromate plating. While the fitting function will not change, the fitting color will. Fittings plated with trivalent chromate will be silver in color, not gold. The new plating process is implemented worldwide at all Parker facilities.

Custom Fittings for Short-Run or Special Applications

Non-standard and customised hose fittings are available from the Rapid Service Unit

The Rapid Service Unit (RSU) can provide:

- Jump sizes
- Specific end-configurations
- Specific drop lengths
- Fitting/tube combinations
- Customised prototypes
- Any batch size upwards from a single piece

Material options include steel, stainless steel, brass and special materials on request.



Going Green: The implications for hoses

Protecting the environment and controlling pollution are gaining momentum in response to priorities being set by governments and local authorities; it is becoming an important factor in the production of many products. Whether in municipal vehicles, construction equipment, agricultural machinery or forestry vehicles, the trend towards using biodegradable oil in hydraulic systems is increasing.

Hose Products Division Europe offers a full range of hoses with pure nitrile inner tubes, from 1 and 2 wire braided through to 6-layer multi-spiral hoses. These hoses offer exceptional hydraulic oil and biodegradable oil compatibility up to 100 °C together with the advantage of no loss in pressure capability.



Hybrid Push-Lok Technology – the excellent combination of two basic materials



Through interactive development of both materials and manufacturing processes, the combination of polyurethane and synthetic elastomer has successfully resulted in the creation of a hybrid Push-Lok hose, with exceptional technical properties.

- Hose cover made of high-quality polyurethane, featuring high resistance to welding spatter and abrasion.
- The high tensile textile braid reinforcement ensures a firm grip of the hose onto the fitting and prevents it from pulling off.
- Synthetic elastomer core tube resistant to hydraulic fluids, dry air, water, water emulsions, etc.

Index

Hose and Fittings Terminology – The basics Aa-1–Aa-4
 Safety Pre-Caution Aa-5
 Safe Hose Assemblies in 8 Steps Aa-6
 1 Application Aa-6
 2 Size Aa-6
 3 Pressure Aa-7
 4 Temperature Aa-7
 5 Fluid Compatibility Aa-8
 6 Hose Fittings Aa-8
 7 Hose Assembly Manufacture Aa-9–Aa-10
 8 Routing / Installation / Environmental influences. Aa-11–Aa-13
 How to Order (Part number description) Aa-14–Aa-15

Technical Data

Hose Overview Ab-2
 Hose Fittings Pressure Ratings Ab-3
 Hose Fittings Overview Ab-4–Ab-5
 Hose Fitting Nomenclature Ab-6–Ab-9
 Classification Body Type Approvals Ab-10–Ab-11
 Conversion Chart Ab-12
 Temperature / Pressure Chart Ab-13
 Flow Capacity Nomogram Ab-14
 The Correct Method to Fit Female Swivel Ends Ab-15
 Chemical Resistance Table Ab-16–Ab-21
 Safety Guide Ab-22–Ab-25
 Identifying Fitting Types Ab-26–Ab-35

Hose and Fittings Terminology – The basics !

Selecting the right hose and fittings combination usually belongs to the last steps in the design of a hydraulic system and its importance is often overlooked and underestimated. The right hose and fitting combination is however, vital for the overall functionality and long term service life of the complete system.

This technical handbook and catalogue will provide a guide to correct hose and fitting selection, as well as highlighting the important safety aspects to their usage as hose assemblies in the field.

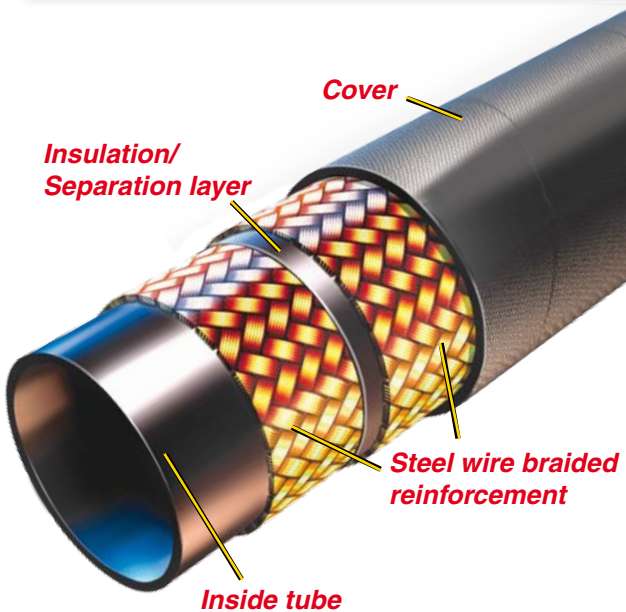

Hose

Typically a rubber hose is constructed of an extruded inside synthetic rubber tube that has the sole purpose to keep the conveyed fluid in the hose. The elastomeric nature of rubber requires that a reinforcement layer be wound or braided around the tube in order to hold the internal pressure. The reinforcement layer(s) are either textile or steel (or both). To protect these inner layers of the hose from the ambient conditions, an outer synthetic rubber cover is extruded around the reinforcement.



Hose Assemblies Hose Assemblies Installation

The combination of a hose and hose fitting(s) to make a hose assembly, is a critical process that needs to be carried out by professionally trained personnel who follow strict assembly instructions. Improperly assembled hose fittings can separate from the hose and may cause serious injury or property damage from whipping hose, or from fire or explosion of vapor expelled from the hose. (See „Safe Hose Assemblies in 8 Steps“, Page Aa-8)

The hose assembly must be operated within specific limits to maximise a safe and long term service life. These limits are defined in this catalogue and also by both governmental standards and institutional organisation’s and specifications such as the ISO 17165-2, SAE J1273 or EN982.

Working Pressure

Hose and fitting selection must be made so that the published maximum recommended working pressure of the Hose and fitting are equal to, or greater than the maximum system pressure. Surge pressures or peak transient pressures in the system must be below the maximum working pressure of the hose assembly. Surge pressures and peak pressures can usually only be determined by sensitive electrical instrumentation that measures and indicates pressures at milli-second intervals. Mechanical pressure gauges indicate only average pressures and cannot be used to determine surge pressures or peak transient pressures.



Proof Pressure Test

This test is typically carried out on customer request according to a method defined by the ISO 1402 standard. The test should be made at normal ambient temperature with a proof test bench using water or another suitable liquid. The hose assembly should be pressurised for between 30 to 60 seconds at twice the working pressure of the hose assembly. There should be no leakage or pressure drop. A complete test report should be provided together with the hose assembly to the customer.

Burst Pressure

All hoses in this catalogue have a pressure design factor of 4:1, implying therefore that the burst pressure (hose destruction) is minimum 4 times the published working pressure.

Published burst pressure ratings for hose are for manufacturing test purposes only – burst pressure should **never** play a role in the selection of a hose.

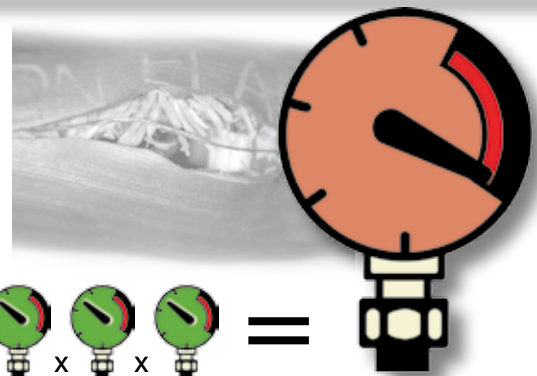

Fluid Compatibility

The hose assembly (hose inner tube, hose outer cover and hose fittings) must be chemically compatible to both the fluid being conveyed by the hose as well as the medium surrounding it. (the chemical resistance table contained in the catalogue, indicates only the resistance of the hose innertube to the respective fluid)

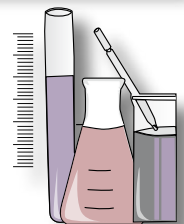

Temperature Range

In order not to negatively effect the properties of the rubber hoses it should be made certain that fluid and ambient temperatures, both steady and transient, do not exceed the limitations of the hose as published in the catalogue. Temperatures below and above the recommended limit will degrade the hose and failure may occur and release fluid.

The mechanical properties of the hose are also influenced by low or high temperatures and should be considered when designing the system.

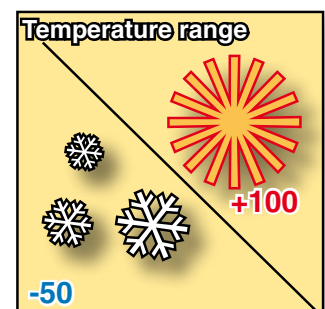

Hose Size

The power transmitted by means of a pressurised fluid varies with pressure and rate of flow.

The size of the components must be adequate to keep pressure drops to a minimum and avoid aging due to heat generation or excessive fluid velocity.

Parker uses the internationally recognised hose dash size as a measurement of the size of their hoses.

This size is a measurement of the inside tube of the hose – not the wall outer diameter.

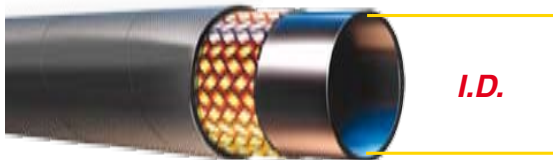

Size	Inch	mm	DN
-6	6/16	$6/16 * 25,4 = 9,525$	10
-6	3/8	9,5	10

Hose Bending Radius

The minimum bend radius of a hose refers to the minimum radius that the hose may be bent through whilst operating at the maximum allowable published working pressure.

Bending radius is not a measurement or indicator of hose flexibility.

The catalogue specified values of bending radii are based on international or Parker specifications and have been proven through rigorous impulse testing of the hose assemblies.

Bending the hose below the minimum bending radius leads to loss of mechanical strength and hence possible hose failure.

A minimum straight length of 1,5 times the hose's outside diameter (D) shall be allowed between the hose fitting and the point at which the bend starts.

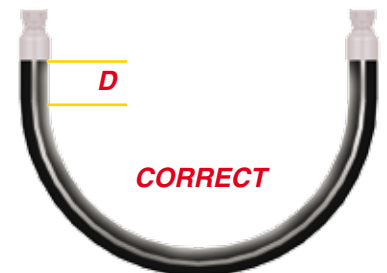
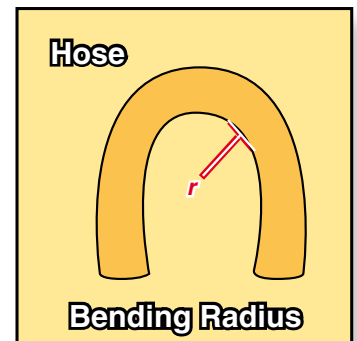

Hose Assembly Routing

The routing of a hose assembly in such a manner so as to avoid any damage to the hose by stretching, compression, kinking or abrasion over sharp edges is essential, to assure maximum service life and safety.

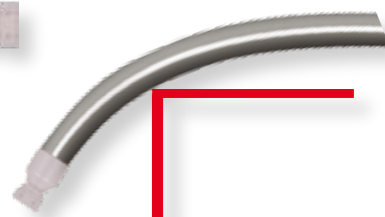

Hose and Fittings Storage

A system of age control should be maintained to ensure that hose is used before its shelf life has expired. Shelf life is the period of time when it is reasonable to expect the hose to retain full capabilities for rendering the intended service. Hose shall be stored in a manner that facilitates age control and first-in, first-out (FIFO) usage based on the manufacturing date on the hose or hose assembly.

The shelf life period of rubber hose in bulk form or hose made from two or more materials (hose assembly) is difficult to define as so many factors can detrimentally influence the hoses suitability for use.

In the German speaking countries the “rules” that must be followed are stated in the DIN 20066:2002-10 and referred to by the general organisation of trade associations (Berufsgenossenschaft) in their actual publication ZH1/74 from April 2005 – safety regulations for hydraulic hose assemblies.

Excerpt DIN 20066:2002-10:

For the production of hose assemblies the hose (bulk hose) must be younger than 4 years according to the hoses date of manufacture. The service life of a hose assembly, including any period of storage should not exceed 6 years; the period of storage should not exceed 2 of these 6 years.

Additionally, the International Standard Organisation (ISO) has prepared a draft version of a guideline for hose/hose assembly usage that differs slightly from the German guideline. The ISO/TR 17165-2 states that the shelf life of hose as bulk hose or as hose made of 2 or more materials should not exceed 40 quarters (10 years) from the date of manufacture of the hose if stored in accordance with ISO 2230.

After all cases of hose storage, if visual inspection gives rise to any doubts as to the functionality of the hose (cracks in the cover, rust etc), pressure testing should be carried out before use or the hose should be disposed of. Hose assemblies should always be considered as safety relevant components, so no risks should be taken.

Hose storage – Best practices:

- Store in a clean, cool and dry area (≈ room temperature)
- Avoid direct sun light or moisture
- Do not store near high power electrical equipment
- Avoid contact with corrosive chemicals
- Avoid Ultraviolet light
- Insects/Rodents
- Radioactive materials

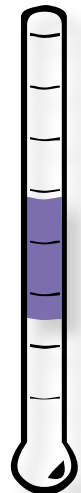

Fittings storage – Best practices:

- Additionally to the factors above the following points should be observed for storage of hose fittings
- Store fittings in clearly marked closed containers such as the original Parker packaging.
- A stock rotation system (FIFO) should be in place so that a shelf life of 2 years is not exceeded for fittings with O-rings as they may degrade as a result of normal environmental conditions, leading to possible system leakages or contamination.

! SAFETY FIRST !

Avoid injury to yourself and others by following these important rules

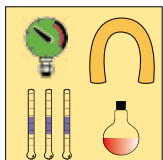

Select proper hose assemblies for the application. Product choice must be based on published hose specifications and must fit the application requirements. Many factors and conditions affecting the inside and outside of the hose must be taken into account.



Refer to the standards, regulations and directories that apply in the countries where the equipment is sold and used.



Follow hose assembly installation good practice!

Hose must not be stretched, kinked, crushed or twisted during installation or use. Hose must not be bent to less than the minimum bend radius.



Use proper safety protection when manufacturing, testing or installing hose assemblies

Hose Size	Crimp Size	Crimp Machine	Part No.
1/4" x 1/4"	1/4"	100	100
1/2" x 1/2"	1/2"	200	200
3/4" x 3/4"	3/4"	300	300
1" x 1"	1"	400	400
1 1/4" x 1 1/4"	1 1/4"	500	500
1 1/2" x 1 1/2"	1 1/2"	600	600
2" x 2"	2"	700	700
2 1/2" x 2 1/2"	2 1/2"	800	800
3" x 3"	3"	900	900
3 1/2" x 3 1/2"	3 1/2"	1000	1000

Parker Hannifin recommends hose and fitting combinations in this catalog only after completing extensive testing – only use approved hose and fitting combinations. – using the Parkrimp hose, fitting and machine concept assures safe hose assemblies!

Always use up to date Parker crimping tables – if in doubt contact HPDE@Parker.com



Do not use hydraulic hose to transmit steam

Establish a program of inspections.

Hose assembly must be carried out by trained personnel. Update training regularly.

WARNING – Fluid injection injuries shall be treated without delay and shall not be treated as a simple cut !

- Fluid under pressure can cause serious injury. It can be almost invisible escaping from a pinhole, and it can pierce the skin into the body.
- Do not touch a pressurized hydraulic hose assembly with any part of your body.
- If a fluid-injection accident occurs, medical treatment by a doctor shall be sought immediately.
- Stay out of hazardous areas while testing hose assemblies under pressure. Use proper safety protection.

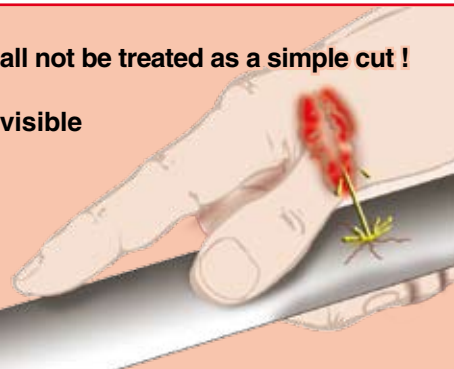

Safe Hose Assemblies in 8 Steps

1 Application

Some applications allow a relatively simple hose selection, eg suction/return lines. Usually however, it is prudent to consider the points below and use them as a guide to help assure all factors have been taken into account. Using the data acquired from considering these points will lead to correct product choice and help assure safety, long service life and optimises the overall cost of the hose assembly.

What is the application of the hose?

- Machine / Equipment type?
- Suction application?
- Working and surge pressures?
- Fluid and/or Ambient temperature?
- Fluid compatibility?
- Non-Conductive Hose Required?

Where will the hose be used?

- Environmental conditions?
- Minimum bend radius?
- Routing requirements? /Clamps, protection sleeves?
- Is the hose exposed excessive abrasion?
- Is the hose subject to Mechanical Loads?

Need to meet national, legal, industry or customer Standards?

- Thread Type? / Does the thread type withstand the system pressure?
- Specific hose construction prescribed?

2 Size

The power transmitted by means of a pressurised fluid varies with pressure and rate of flow. The size of the components (hose and fittings) must be adequate to keep pressure drops to a minimum and avoid damage due to heat generation or excessive fluid velocity.

If the required size of hose is not already known, the **Hose Capacity Nomogram** on Page Ab-14, may assist.

The size of standard hoses is specified by the inside diameter of the tube.

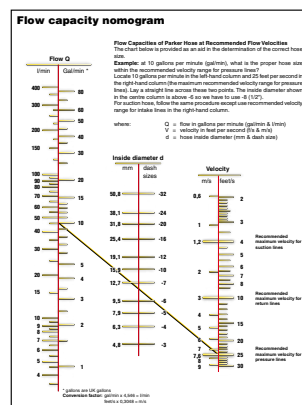
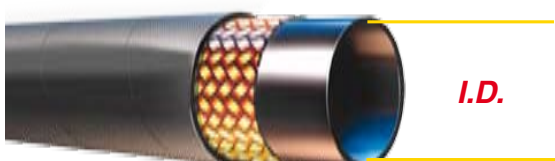

3 Pressure

Hose and fitting selection must be made so that the maximum recommended working pressure of the hose assembly is equal to or greater than the maximum system pressure. Surge pressures or peak pressures must be below this maximum working pressure.

Throughout the catalogue the pressures are specified in Mega Pascals.
 eg. 27,6 Mpa = 276 bar = 4000 psi
 (A full conversion table for other units of measurement can be found on Page Ab-12)

After defining the size of hose required the Hose Selection Overview table on Page Ab-2 can be used to select the appropriate hose(s).

This table provides a quick reference showing the hose types offered in the catalogue, their temperature rating, their construction and the specification to which they adhere.

	Unit	SI Unit	Conversion Unit	Factor
Length	1 foot	m	metre	25.4
	1 centimetre	cm	in	0.393701
	1 foot	m	in	0.3048
Area	1 square centimetre	cm ²	sq. in.	0.1550
	1 gallon (US)	gal	l	4.54609
	1 gallon (UK)	gal	l	4.54609
Volume	1 litre	l	gal (US)	0.264172
	1 gallon (US)	gal	l	3.78533
	1 litre	l	gal (UK)	0.220462
Weight	1 pound	lb	kg	0.453592
	1 kilogramme	kg	lb	2.20462
	1 pound force	lb = 5	kg = m	1.48946
Torque	1 foot pound	ft.lb	kg.m	1.35582
	1 pound per square inch	psi	bar	0.06895
	1 bar	bar	psi	14.5038
Pressure	1 pound per square inch	psi	MPa	0.006895
	1 kilopascal	kPa	bar	0.01
	1 bar	bar	MPa	0.1
Velocity	1 foot per second	ft./s	m/s	0.3048
	1 metre per second	m/s	ft./s	3.28084
	1 gallon per minute (US)	gal./min.	l/min.	4.54609
Flow rate	1 litre per minute	l/min.	gal./min. (UK)	0.220462
	1 gallon per minute (UK)	gal./min.	l/min.	3.78533
	1 litre per minute	l/min.	gal./min. (US)	0.264172
Temperature	Fahrenheit degree	°F	°C	5/9 * (°F - 32)
	Celsius degree	°C	°F	°C * 9/5 + 32

Hose fitting's pressure rating

This is a subject often neglected by both designers and producers of hose assemblies alike. The pressure rating of a hose assembly is determined by the pressure rating of the component in the hose assembly with the lowest working pressure.

Considering therefore only the pressure rating of the hose is NOT enough! Quite often the pressure rating of the fittings can lie below that of the hose; so to avoid any safety risks caused by non-compatibility of the fittings for the desired system pressure rating, the maximum working pressures of the Parker fittings in this catalogue can be found in Page Ab-3.

4 Temperature

The temperature of the fluid in the hose and the ambient temperature around the hose in combination with the medium of both the conveyed fluid and the environment, need to be carefully considered in the hose selection process. The temperatures in the catalogue refer to the temperatures of the fluid in the hose.

High Temperature

In general the combination of high temperatures and high pressures reduce the service life of the hose. More regular inspection of the hose assemblies should be carried out to assure the continued safe functionality of the hose assembly. If the outer cover is brittle or cracked, the hose assembly should be replaced.

To maximise hose service life choose Parker high temperature hoses with part numbers ending with 6, eg 436 - SAE 100 R16 high temperature hose.

Low Temperatures

In general cold temperatures reduce the flexibility of rubber products. The minimum specified temperature designates the minimum temperature that the hose may be subjected to before, during a cold-bending test, visible cracks appear in the rubber hose cover.

For extremely low temperatures Parker LT products should be selected, eg. 461LT – EN857-2SC Low Temperature hose

5 Fluid Compatibility

It is vital for long service life and leak free functionality that the hose assembly (hose inner tube, hose outer cover and hose fittings and O-rings) be chemically compatible to both the fluid being conveyed through the hose as well as the environment of the hose. (The chemical resistance table contained in the catalogue, indicates only the resistance of the hose innertube to the respective fluid)

Page Ab-16 shows a comprehensive chemical compatibility table for the Hose Products Division's hoses.

Should the table not contain the required chemical compatibility information required, please contact Parker by email using HPDE@Parker.com

6 Hose Fittings

Hose ends, or hose fittings as commonly named, tend to be specified by the machine port that the hose is to be attached to and are heavily influenced by the country of origin. Despite many efforts being made to standardise and rationalise connection types, many connection systems still exist due to national or international standards or even specific to a customer or a market segment. In general there are five main fittings systems generally used for hydraulic connections today, whereby the overall list is much longer.

European Thread Types:

- German – (DIN)
- British – (BSP)
- French – (GAS & Metric)
- North American – (SAE)
- Japanese – (JIS)

In order to assure a long service life and leak free running of the system the fitting style and the sealing type of the fitting should be considered in the design process.

Safety First !!

Hose / Hose Fitting Compatibility

Parker undertakes intensive testing of the hoses and fittings to assure that the respective Parker fittings series is compatible with the designated hose, as shown in the catalogue.

Parker take no responsibility to assure that hose from another manufacturer is compatible with Parker hose fittings, nor does Parker take responsibility for other manufacturers fittings compatibility with Parker hose.

Identifying Fitting Types

In general fittings can be identified by their visual appearance, their sealing surface/ sealing type or by their thread type/form.

On page Ab-26, there is a comprehensive fitting identification guide that will help both identification of the thread and the sealing mechanism.

7 Hose Assembly Manufacture

 **Parker representatives can support you with training or advice !**

Cutting and hose length

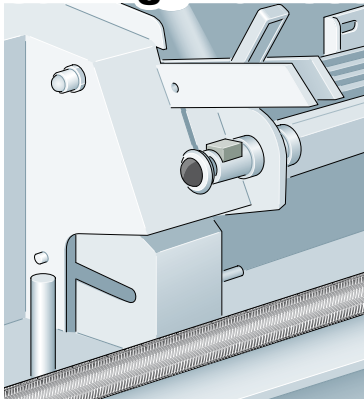

Hose is cut to the desired length according to specifications.

The correct hose cutting tool ensures a square, clean cut without damaging the pressure reinforcement. Depending on the hose type, different kinds of blades must be used: 1) smooth blade, 2) scolloped blade

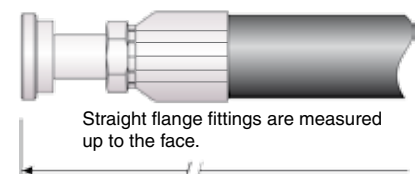
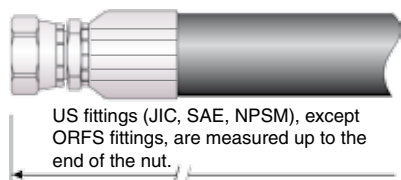
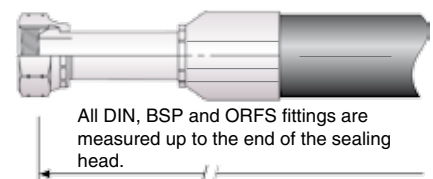
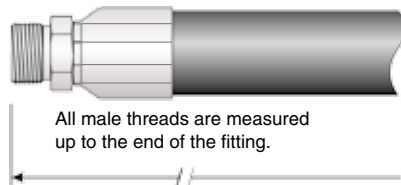

Tolerances for hose assemblies

Length tolerance according to DIN 20066:2002-10 and EN 853 to EN 857

Hose assembly length	up to DN25	from DN32	from DN60
	(size -16)	(size -20) up to DN50 (size -32)	(size -40)
up to 630	+7 -3	+12 -4	+25 -6
over 630 up to 1250	+12 -4	+20 -6	
over 1250 up to 2500	+20 -6	+25 -6	+1,5 % -0,5 %
over 2500 up to 8000		+1,5 % -0,5 %	
over 8000		+3 % -1 %	

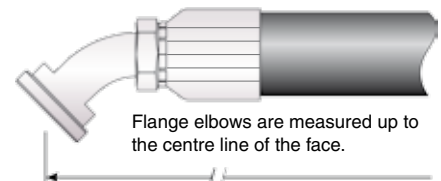
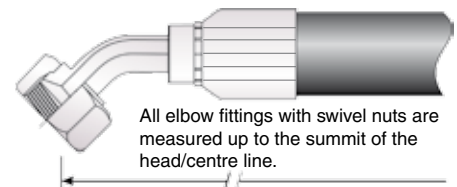

Marking

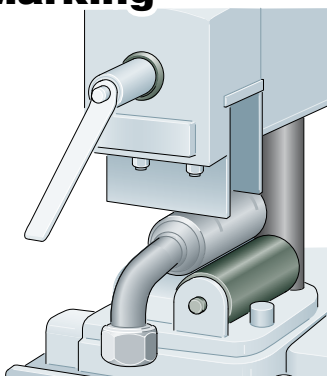

According to EN and ISO standards, hose assemblies must be clearly and permanently marked.

They must bear the following informations:

- manufacturer's identification
- date of production (year and month)
- maximum permissible working pressure limit of hose assembly

Crimping

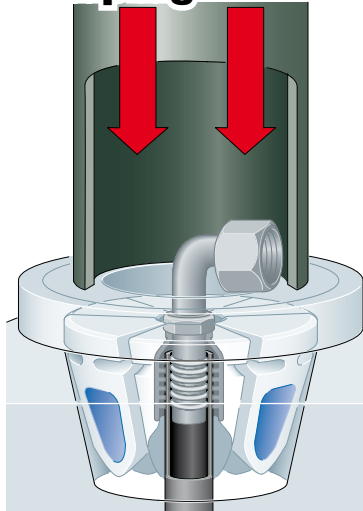

Crimping is the safest, fastest and most commonly used method of making a hose assembly. The Parker crimping systems ensure precise, leak-free and tear-proof assembly of hose and fitting. Reaching the exact crimping diameter is possible with Parkrimp crimping tools or freely adjustable crimping tools.

When crimping, it is essential that hose, fitting and crimping tool (dies) match precisely (see Parker crimping tables on pages Ed-1 -Ed-10). Furthermore, the insertion depth, a square cut hose, correct, burr-free and clean crimping are important to ensure a correctly formed and leak-free connection of hose and fitting. Using the ParKrimp hose crimpers or free adjustable crimpers, the fitting is crimped onto the hose in one slow and smooth crimping procedure. A depth stop with automatic function ensures safe positioning of the fitting. This guarantees the correct crimping of hydraulic hose assemblies.

26, 46, 48, 70, 71, 73, 78, 79, S6 series:

Push the hose all the way into the coupling. Place the hose next to the fitting shell and mark the insertion depth or the length of the fitting onto the hose – (lubricate hose end if necessary) push hose into the fitting until the mark on the hose is even with the end of the shell.

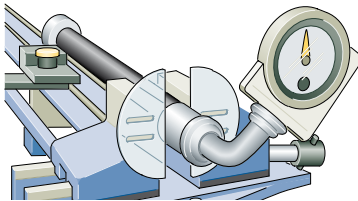
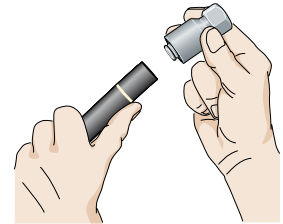

Angle setting

The displacement angle of a hose assembly is indicated only when two elbow fittings are assembled in a displaced way.

The angle always has to be indicated clockwise looking from the elbow fitting at the back to the one in the front. Please also consider the natural bending of the hose.

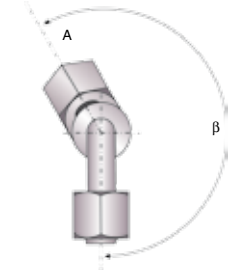

Testing

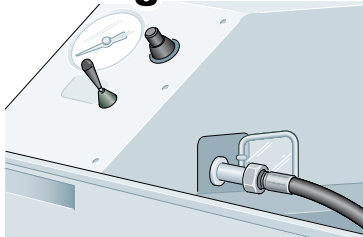

Static test pressure depending on the hose type and application is applied to the finished hose assembly for a pre-defined period of time. The test procedure can be documented using a test logging unit. The test pressure for Parker hydraulic hose assemblies is 2 times the value of the dynamic operating overpressure.

Proof Pressure Test – This test is typically carried on customer request according to a method defined by the ISO 1402 standard. The test should be made at normal ambient temperature with a proof test bench using water or another suitable liquid. The hose assembly should be pressurised for between 30 to 60 seconds at twice the working pressure of the hose assembly. There should be no leakage or pressure drop. A complete test report should be provided together with the hose assembly to the customer.

Cleaning

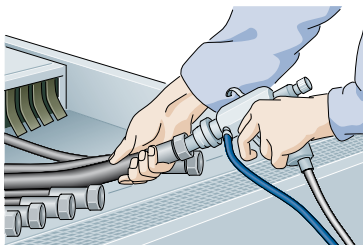

The hydraulic systems have to reach a defined degree of cleanliness. For this purpose we use cleaning devices which ensure fast and efficient cleaning of hose assemblies. With the TH6-6 standard cleaning device, cleanliness class 17/14 according to ISO 4406 can be achieved. For higher degrees of cleanliness, the TH6-6 device needs to be equipped with a different filter cartridge (see chart). This cleaning device first washes the hose assembly with a detergent and an anticorrosive agent and then blows it out with pressurised air. For permanent protection of the finished hose assembly against impurities we recommend using plastic caps.

ISO 4406	NAS 1638	SAE 749	Cartridge
11/8	2		
12/9	3	0	
13/10	4	1	
14/11	5	2	
15/12	6	3	
16/13	7	4	3 μ
17/14	8	5	3 μ
18/15	9	6	3 μ
19/16	10		3 μ
20/17	11		
21/18	12		



According to EN 982, hose assemblies are not permitted to be manufactured from any components that have already been in use in other hose assemblies.

8 Routing / Installation / Environmental Influences

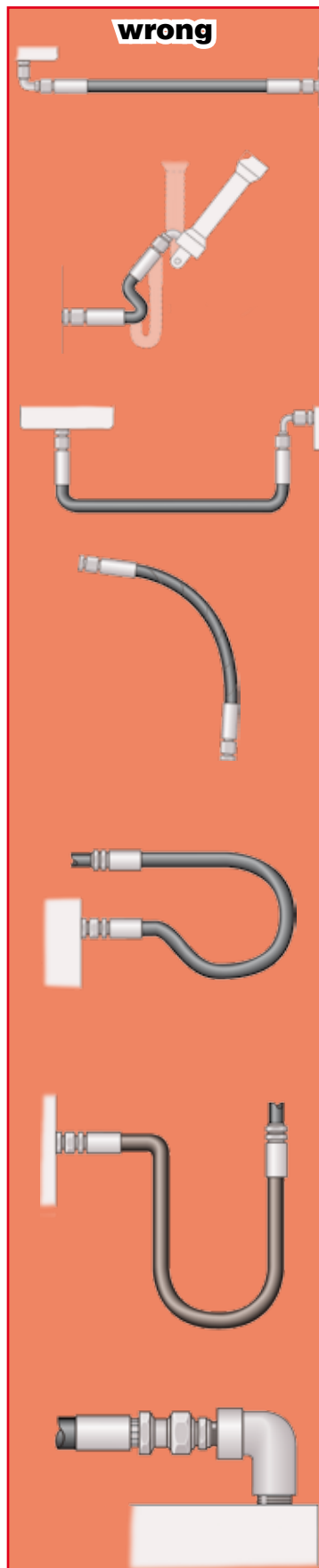

The **routing** of the hose assembly and the environment in which the hose assembly operates directly influence the service life of the hose assembly. The following diagrams indicate the correct routing of hose assemblies that will maximise its service life and assure a safe working functionality.

When hose installation is straight, it must be assured that there is enough slack in the hose to allow for changes in length that occur when pressure is applied. When pressurized, hose that is too short may pull loose from its hose fittings or stress the hose fitting connections, causing premature metallic or seal failures.

The **hose length** must be determined so that the hose assembly has enough slack to allow the system components to move or vibrate without creating tension in the hose.

However, care needs to be taken not to allow too much slack and therefore introduce the risk of the hose snagging on other equipment or rubbing on other components.

Mechanical straining of the hoses needs to be avoided, so the hose must not be bent below its minimum bending radius or twisted during installation. The minimum bending radii for each hose is stated in the hose tables in the catalogue.

The plane of movement must also be considered and the hose routing selected accordingly.

Hose routing also plays an important role on the selection of the hose fittings, as the correct fittings can avoid straining the hoses, unnecessary hose length or multiple threaded joints.

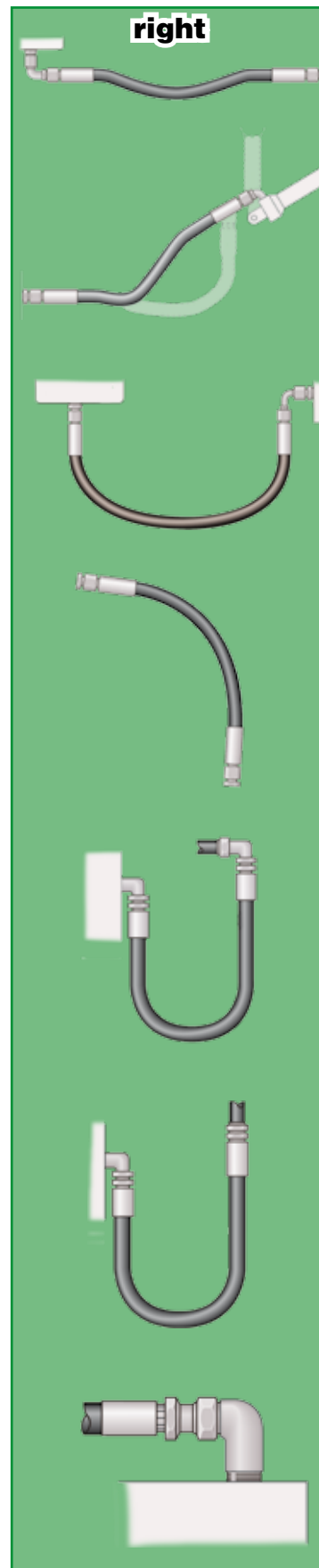

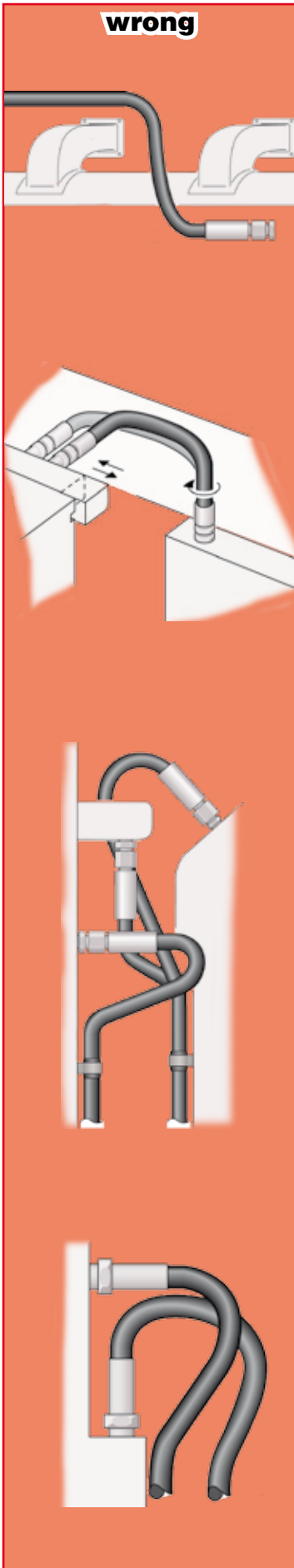

wrong

Correct clamping (holding/supporting) of the hose should be exercised to securely route the hose or to avoid the hose contacting surfaces that will cause the hose damage.

It is however, vital that the hose be allowed to keep its functionality as a “flexible-pipe” and not be restricted from changing in length when under pressure.

It should also be noted that hoses for high- and low-pressure lines shall not be crossed or clamped together, as the difference in changes in length could wear the hose covers.

Hose should not be bent in more than one plane. If hose follows a compound bend, it shall be coupled into separate segments or clamped into segments that each flex in only one plane.

Hoses should be kept away from hot parts as high ambient temperatures shorten hose life. Protective insulation may need to be used in unusually high ambient temperature areas.

Whilst the importance of the functionality is prime the aesthetics and practicality of the installation should also be considered in the design. It should be considered that maintenance might be necessary at some stage in the future, so prohibitive design routings should be avoided.

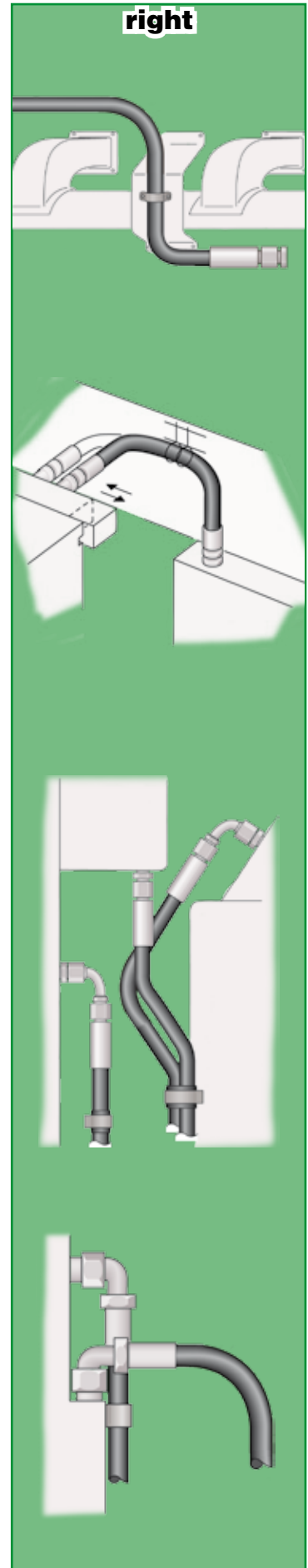

right

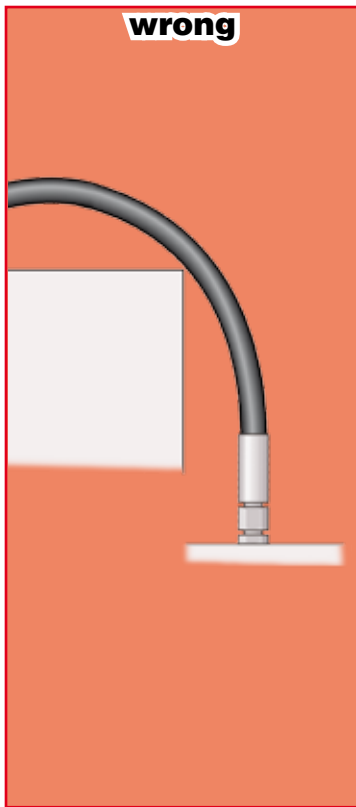

Abrasive influences

In general care should be taken that the hose is not exposed to direct surface contact that will cause abrasive wearing of the outer cover (either hose to object or hose to hose contact). If however, the application is such that this cannot be avoided, either a hose with a higher abrasion resistant hose cover or a protective sleeve need to be used.

Parker **TOUGH COVER (TC)** or **SUPER TOUGH (ST)** covers offer 80 times or respectively 1000 times the abrasion resistance of standard rubber covers.

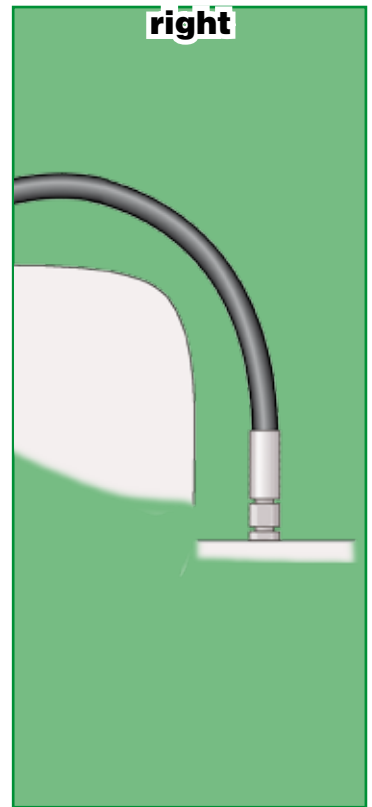

Pollution of hydraulic circuits

Modern hydraulic equipment is becoming highly precise and as such more sensitive, so as a result the importance of a clean working fluid in the system is growing. Because as many as 75% of hydraulic system failures are caused by contamination of the fluid by solid particles, the initial cleanliness of hydraulic components, as the main source of these contaminates, is vital.

With hose assemblies most of the pollution/contaminates enter the hose assembly during its production and mainly during the cutting (or skiving) process.

In order to avoid system failures, all hose assemblies should be cleaned before use (cleaned and plugged before shipping) with suitable cleaning equipment such as the Parker TH6-6 machine. This cleaning device first washes the hose assembly with a detergent and an anticorrosive agent and then blows it out with pressurized air.

The level of contamination is defined in three popular norms: ISO4406, ISO4405 or NAS 1638. Most common however, is the ISO 4406, which describes the number and size of solid particles in the hydraulic system by means of a classification value e.g. 16/13.

With the Cleaning Machine TH6-6 you can reach the following classification values when using the 3 microns filter cartridge

ISO 4406	NAS 1638	SAE 749	Cartridge
11/8	2		
12/9	3	0	
13/10	4	1	
14/11	5	2	
15/12	6	3	
16/13	7	4	3 μ
17/14	8	5	3 μ
18/15	9	6	3 μ
19/16	10		3 μ
20/17	11		
21/18	12		



How to Order

To make ordering Parker products easier, we have itemized the order numbers on this page. This will be especially helpful when you order hose assemblies. You can find further useful hints on the following page.

1. Hose

Example: **436-6**

436-6 > Hose type

436-6 > Hose **inside diameter** in size

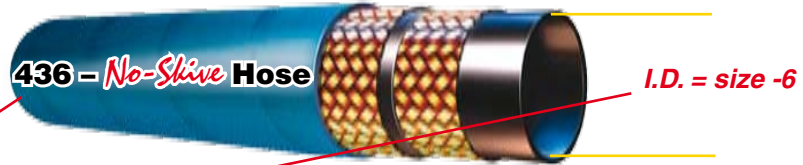

2. Hose Fittings

Example: **1 CA 48 12-6**

1 CA 48 12-6 > Fitting

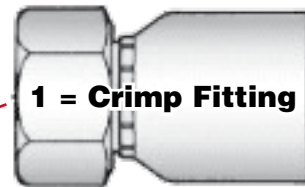

1 CA 48 12-6 > End configuration nomenclature

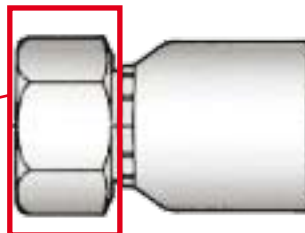

1 CA 48 12-6 > Parker Fitting series

1 CA 48 12-6 > Thread or Tube size

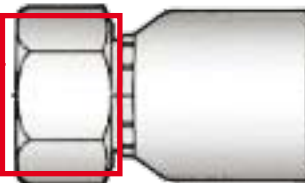

1 CA 48 12-6 > Hose size and hose fitting size

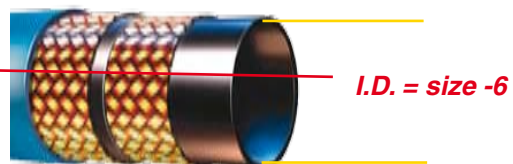

Material/ specification:

- Without suffix: steel, zinc plated
- B: brass
- C: stainless steel
- K: without a plastic ring
- SM: metric hexagon dimension

The content of the hose crimping tables shows the standard part numbers. For the availability of non standard parts/materials please contact your local Parker service centre. All part numbers printed in bold in the respective price list are available ex-stock.

3. Hose Assemblies

Example: **P436CACF12106-1000-0-SG900**

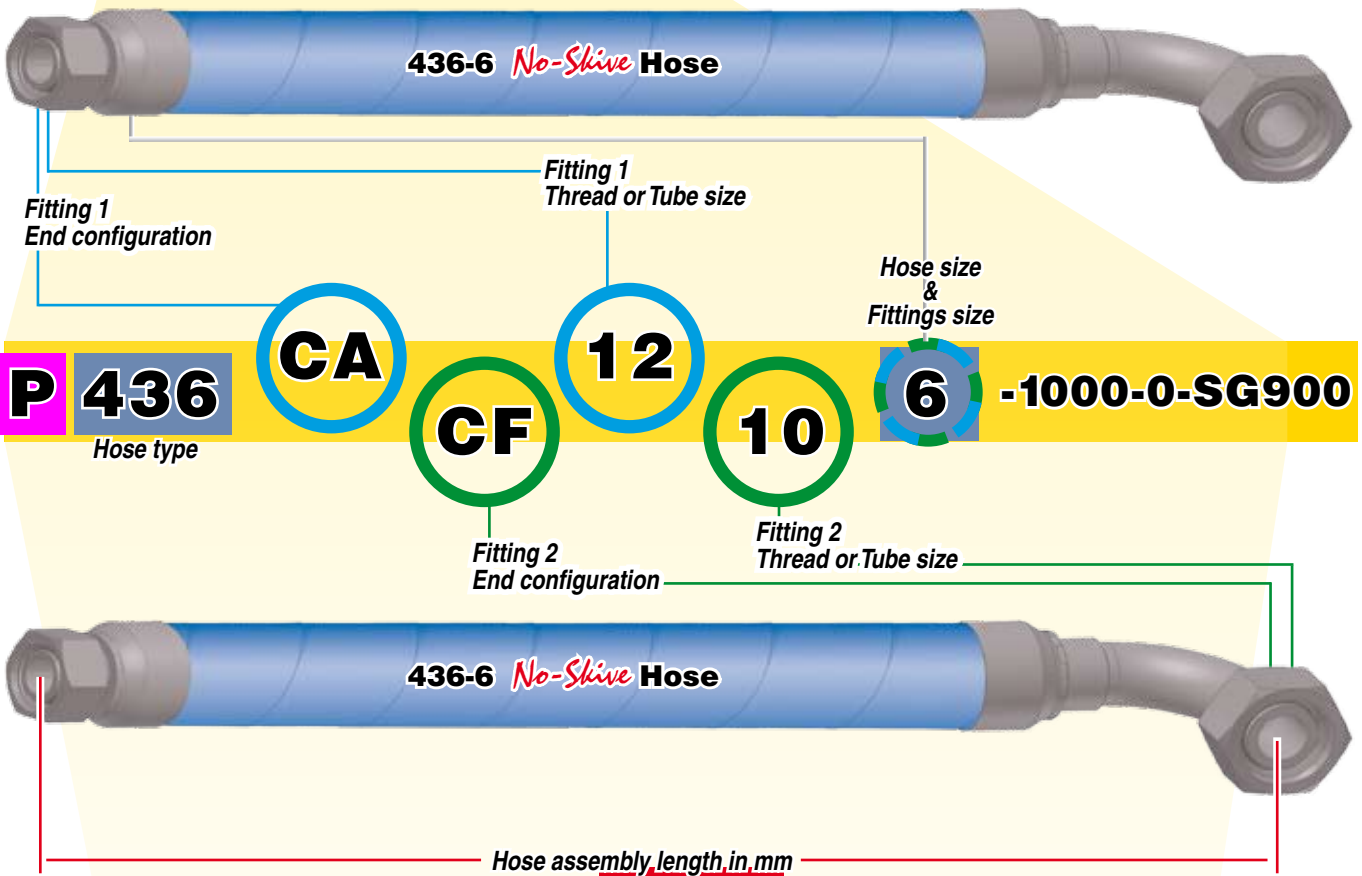

P **436** **CA** **CF** **12** **10** **6** **-1000-0-SG900**
 Hose type

P436CACF12106-1000-0-SG900

D = Parkrimp No-Skive Fittings Series 46
 F = Parkrimp No-Skive Fittings Series 70, 71, 73, 78, 79 and S6
 P = Parkrimp No-Skive Fittings Series 48
 R = Low Pressure Push-Lok Fittings Series 82

Accessory,
 e.g. spring guard 900 mm length

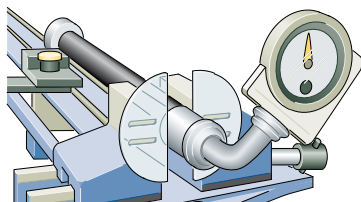

Displacement angle is relevant when the hose assembly has bent fittings

SG	Spring Guard
AG	Armour Guard
AS/PS	Partek Nylon protective sleeve
FS	Fire Sleeves
HG	PolyGuard-Hose Protector
PG	Parkoil-Hose Protector

Hose assembly with hose 436 in size -6 and fitting series 48. Hose assembly length 1000 mm.
 Fitting 1: end configuration CA has a 12 mm pipe diameter and has a size -6 hose nipple
 Fitting 2: end configuration CF has a 10 mm pipe diameter and has a size -6 hose nipple
 The displacement angle for this combination is 0 degree. On request a displacement angle can be specified for the bent fitting in relation with the hose curvature. A protection sleeve as a Spring Guard in length 900 mm is on the hose assembly.

Technical Data

Hose Overview	Ab-2
Hose Fittings Pressure Ratings	Ab-3
Hose Fittings Overview	Ab-4–Ab-5
Hose Fitting Nomenclature	Ab-6–Ab-9
Classification Body Type Approvals	Ab-10–Ab-11
Conversion Chart	Ab-12
Temperature / Pressure Chart	Ab-13
Flow Capacity Nomogram	Ab-14
The Correct Method to Fit Female Swivel Ends	Ab-15
Chemical Resistance Table	Ab-16–Ab-21
Safety Guide	Ab-22–Ab-25
Identifying Fitting Types	Ab-26–Ab-35

Hose Overview

	Hose size DN DN	Working Pressure MPa (safety factor 4:1)										Temperature Range °C	Reinforcement	EN	ISO	SAE	Page			
		-4 06 05	-5 08 06	-6 10 08	-8 12 10	-10 16 12	-12 20 16	-16 25 22	-20 32 29	-24 40 35	-32 50 46									
Low Pressure Push-Lok Hoses	801	1,7		1,7	1,7	1,7	1,7	1,2						-40/+100	1 braid, fibre				B1a-1	
	804	9,0		9,0	9,0		9,0							-40/+80	1 braid, fibre				B1a-2	
	821FR	2,4		2,0	2,0		1,7							-40/+100	1 braid, fibre				B1a-3	
	830M	1,6		1,6	1,6	1,6	1,6							-20/ +60	1 braid, fibre				B1a-4	
	831	2,4		2,0	2,0	2,0	2,0							-40/+100	1 braid, fibre				B1a-5	
	836	1,7		1,7	1,7	1,7								-40/+150	1 braid, fibre				B1a-6	
	837BM	1,6		1,6	1,6	1,6	1,6							-40/+100	1 braid, fibre				B1a-7	
	837PU	1,6		1,6	1,6	1,6	1,6							-40/+100	1 braid, fibre				B1a-8	
	838M	1,6		1,6	1,6	1,6	1,6							-20/ +60	1 braid, fibre				B1a-9	
Low Pressure Specialty Hoses	201	20,7	20,7	15,5	13,8	12,0	10,3	5,5	4,3	3,5	2,4			-50/+150	1 braid, wire		SAE 100 R5/SAE J1402 AII		B2a-1	
	206	20,7	20,7	15,5	13,8	12,0	10,3	5,5	4,3	3,5	2,4			-50/+150	1 braid, wire		SAE 100 R5/SAE J1402 AII		B2a-2	
	213	13,8	10,3	10,3	8,6	6,9	5,2	2,8	2,1	1,7	1,4			-40/+150	1 braid, wire		SAE J1402 AI		B2a-3	
	221FR		3,5	3,5	3,5	3,5	3,5	3,5						-20/+100	1 braid, wire		SAE J1527 Typ R3		B2a-4	
	285	2,7		2,7	2,7	2,7	2,7							-30/+125	1 braid, wire		SAE J2064 Typ C		B2a-5	
	293	3,5		3,5	3,5	3,1	3,1	3,1						-50/+150	1 braid, fibre		SAE J1402 AI		B2a-6	
	601	8,6		7,8	6,9		5,2	3,9						-40/+125	2 braids, fibre	EN 854-R3		SAE 100 R3		B2a-7
	611HT	2,8		2,8	2,8	2,4	2,1							-40/+150	1 braid, fibre	EN 854-R6				B2a-8
	681DB	7,5	6,8	6,3	5,8	5,0	4,5	4,0						-40/+100	2 braids, fibre	EN 854-2TE				B2a-9
Medium Pressure	301SN	40,0	35,0	33,0	27,5	25,0	21,5	16,5	12,5	9,0	8,0			-40/+100	2 braids, wire	EN 853-2SN		SAE 100 R2 AT		Ca-1
	302	40,0	35,0	33,0	27,5	25,0	21,5	16,5	12,5	9,0	8,0			-40/+100	2 braids, wire	EN 853-2SN	ISO S 1436	SAE 100 R2 AT		Ca-2
	304	34,5		27,5	24,0		15,5	13,8	11,2	8,6	7,8			-40/+80	2 braids, wire			SAE 100 R2 AT		Ca-3
	402	10,0	10,0	10,0	10,0									-40/+100	1 braid, wire					Ca-4
	421RH								6,3	5,0	4,0			-40/+100	1 braid, wire	EN 853-1SN	ISO S 1436-1	SAE 100 R1 AT		Ca-5
	421SN	22,5	21,5	18,0	16,0	13,0	10,5	8,8	6,3	5,0	4,0			-40/+100	1 braid, wire	EN 853-1SN	ISO S 1436-1	SAE 100 R1 AT		Ca-6
	421WC	19,0		15,5	13,8		8,6	6,9						-40/+121	1 braid, wire		ISO S 1436-1	SAE 100 R1 AT		Ca-7
	422	22,5	21,5	18,0	16,0	13,0	10,5	8,8	6,3	5,0	4,0			-40/+100	1 braid, wire	EN 853-1SN	ISO S 1436-1	SAE 100 R1 AT		Ca-8
	424							6,9	4,3	3,5	2,4			-40/ +85	1 braid, wire			SAE 100 R1 AT		Ca-9
	426	19,2		15,7	14,0	10,5	8,7	7,0						-48/+150	1 braid, wire			SAE 100 R1 AT		Ca-10
	436			27,5	24,0	19,0	15,5	13,8						-50/+150	2 braids, wire			SAE 100 R16		Ca-11
	441	34,5	29,3	27,5	24,0	19,0	15,5	13,8						-40/+125	1 braid, wire		ISO 11237-1-R16	SAE 100 R16		Ca-12
	441RH	34,5	29,3	27,5	24,0	19,0	15,5	13,8						-40/+125	1 braid, wire		ISO 11237-1-R16	SAE 100 R16		Ca-13
	451TC	21,0		21,0	21,0	21,0	21,0	21,0						-40/+100	1 braid, wire		ISO 11237-1-R17	SAE 100 R17		Ca-14
	461LT	42,5	40,0	35,0	31,0	28,0	28,0	21,0						-50/+100	2 braids, wire	EN 857-2SC				Ca-15
	462	42,5	40,0	35,0	31,0	28,0	28,0	21,0	17,2					-40/+100	2 braids, wire	EN 857-2SC	ISO 11237-1-2SC			Ca-16
	462ST	42,5	40,0	35,0	31,0	28,0	28,0	21,0						-40/+100	2 braids, wire	EN 857-2SC	ISO 11237-1-2SC			Ca-17
	463		40,0	40,0	35,0									max.+ 120	2 braids, wire					Ca-18
	471TC	40,0	36,0	35,0	29,7	25,0	21,5	17,5						-40/ + 100	2 braids, wire	EN 857-2SC	ISO 11237-1-2SC			Ca-19
	472TC								15,7	12,5	9,0			-40/ + 100	1 braid, wire	EN 857-2SC	ISO 11237-1-2SC			Ca-19
	492	28,0	25,0	22,5	19,0	15,0	15,0	11,0	7,5					-40/+100	1 braid, wire	EN 857-1SC	ISO 11237-1-1SC			Ca-20
	492ST	28,0	25,0	22,5	19,0	15,0	15,0	11,0						-40/+100	1 braid, wire	EN 857-1SC	ISO 11237-1-1SC			Ca-21
	493	20,0	20,0	20,0	17,5									max. 120	1 braid, wire					Ca-22
	692	21,0	21,0	21,0	21,0	21,0								-40/ +80	1/2 braids, wire				SAE 100 R17	Ca-23
	692Twin	21,0	21,0	21,0	21,0	21,0								-40/ +80	1/2 braids, wire				SAE 100 R17	Ca-24
	811						2,1	1,7	1,4	1,0	0,7			-40/+100	1 braid, 1 steel spiral				SAE 100 R4	Ca-25
881						2,1	1,7	1,4	1,0	0,7			-40/+121	1 braid, 1 steel spiral				SAE 100 R4	Ca-26	
High Pressure	371LT			44,5	41,5	35,0	35,0	28,0						-50/+100	3 braids, wire					Da-1
	372			44,5	41,5	35,0	35,0	28,0						-40/+100	3 braids, wire					Da-2
	372RH			44,5	41,5	35,0	35,0	28,0						-40/+100	3 braids, wire					Da-3
	372TC			44,5	41,5	35,0	35,0	28,0						-40/+100	3 braids, wire					Da-4
	701			45,0	41,5	35,0	35,0	28,0	21,0	18,5				-40/+100	4 spiral, wire	EN 856-4SP	ISO 3862-1-4SP			Da-5
	721TC			28,0	28,0	28,0	28,0	28,0	21,0	17,5	17,5			-40/+125	4 spiral, wire	EN 856-R12	ISO 3862-1-R12	SAE 100 R12		Da-6
	731						42,0	38,0	32,0	29,0	25,0			-40/+100	4 spiral, wire	EN 856-4SH	ISO 3862-1-4SH			Da-7
	774						28,0	28,0	21,0	17,5	17,5			-40/ +80	4 spiral, wire					Da-8
	781						35,0	35,0	35,0	35,0				-40/+125	4/6 spiral, wire	EN 856-R13	ISO 3862-1- R13	SAE 100 R13		Da-9
	P35										35,0			-40/+125	6 spiral, wire	EN 856-R13	ISO 3862-1- R13	SAE 100 R13		Da-10
	791TC						42,0	42,0	42,0	42,0				-40/+125	4/6 spiral, wire	EN 856-R15	ISO 3862-1- R15	SAE 100 R15		Da-11
	792TC						42,0	42,0						-40/+125	4/6 spiral, wire	EN 856-R15	ISO 3862-1- R15	SAE 100 R15		Da-12

Hose Fittings Pressure Ratings

Fitting end connection	Description	Metric tube size in mm									
		Maximum working pressure (MPa) – safety factor 4:1									
		4	5	6	8	10	12	16	20	24	32
92, B1, B2, B4, B5	BSP swivel female	63,0		55,0	43,0	37,5	35,0	28,0	25,0	21,0	21,0
EA, EB, EC	BSP swivel female with O-ring	40,0		40,0	35,0	35,0	31,5	25,0	20,0	16,0	12,5
91, D9	BSP male	63,0		55,0	43,0		35,0	28,0	25,0	21,0	21,0
01	NPTF male	34,5		27,5	24,0		21,0	17,0	15,0	14,0	14,0
02	NPTF female	34,5		27,5	24,0		21,0	17,0	15,0	14,0	14,0
03, 33	SAE (JIC) 37° male	41,0	41,0	34,5	34,5	34,5	34,5	27,5	20,0	17,0	17,0
04	SAE 45° male	41,0	41,0	34,5	34,5	34,5	34,5	27,5	20,0	17,0	17,0
05	SAE male with O-ring	41,0	41,0	34,5	34,5	34,5	34,5	27,5	20,0	17,0	17,0
06/68,37/3V, 39/3W, L9, 41/3Y	SAE (JIC) 37° swivel female	41,0	41,0	34,5	34,5	34,5	34,5	27,5	20,0	17,0	17,0
93	Female SAE (JIC) 37° 90° Elbow	41,4	41,0	34,5	34,5	34,5	34,5	27,5	20,0	17,0	17,0
07	Female NPSM-pipe swivel	34,5		27,5	24,0		21,0	17,0			
08, 77, 79	Female SAE 45° swivel	41,0	41,0	34,5	34,5	34,5	34,5	27,5	20,0	17,0	17,0
1L	Male NPTF pipe swivel 90° Elbow	21,0	21,0	21,0	21,0	19,0	15,5	14,0	11,0	9,0	8,0
S2	Female NPTF pipe swivel	21,0	21,0	21,0	21,0	19,0	15,5	14,0	11,0	9,0	8,0
0G, 0L	Male SAE O-Ring	21,0	21,0	21,0	21,0	19,0	15,5	14,0	11,0	9,0	8,0
28, 67, 69	SAE Male inverted 45° swivel	19,0	17,0	15,0	14,0						
15, 16, 17, 18, 19, 26, 27, 89	SAE flange Code 61				34,5	34,5	34,5	34,5	27,5	21,0	21,0
4A, 4N, 4F	SAE flange 5000 psi								34,5	34,5	34,5
6A, 6E, 6F, 6G, 6N, XA, XF, XG, XN	SAE flange Code 62 6000 psi				41,0		41,0	41,0	41,0	41,0	41,0

Fitting end connection	Description	Metric tube size in mm									
		Maximum working pressure (MPa) – safety factor 4:1									
		4	5	6	8	10	12	16	20	24	32
JM, J6, J8, J0, JU	ORFS male	41,0		41,0	41,0	41,0	41,0	41,0	27,5	27,5	
JC, JS, J3, J7, J9, J5, J1	ORFS swivel female	41,0		41,0	41,0	41,0	41,0	41,0	27,5	27,5	
JD	Male ORFS Bulkhead with Locknut with O-ring	41,0		41,0	41,0	41,0	41,0	41,0	27,5	27,5	
GU	JIS / BSP swivel female 60° cone	35,0	35,0	35,0	35,0	28,0	28,0	21,0	17,5		
FU	Female JIS / BSP 30° parallel pipe swivel	35,0	35,0	35,0	35,0	28,0	28,0	21,0	17,5		
MU	JIS 30° metric swivel female	35,0	35,0	35,0	35,0	28,0	28,0	21,0	17,5		
MZ	Metric swivel female 90° Elbow	35,0	35,0	35,0	35,0	28,0	28,0	21,0	17,5		
UT	JIS / BSP male 60° cone	35,0		35,0	35,0		28,0	21,0	17,5		
V1	Banjo soft seal with UNF bolt	25,0	25,0		21,5	21,5	20,0				
V3	Banjo soft seal with BSPP bolt	25,0	25,0		21,5	21,5	20,0				

Fitting end connection	Description	Metric tube size in mm • Light series – L									
		Maximum working pressure (MPa) – safety factor 4:1									
		6	8	10	12	15	18	22	28	35	42
C3, C4, C5	DIN 20078 swivel female Form A	25,0	25,0	25,0	25,0	25,0	16,0	16,0	10,0	10,0	10,0
CA, CE, CF	DIN 20066:2002-10 swivel female with O-ring, Form N	31,5	42,5	40,0	35,0	31,5	31,5	28,0	21,0	16,0	16,0
DO, DF DG, DK	DIN 20066:2002-10 male stud, Form D	25,0	42,5	40,0	35,0	31,0	28,0	28,0	21,0	16,0	16,0
DX	Metric swivel female with O-ring	31,5	42,5	40,0	35,0	31,5	31,5	28,0	21,0	16,0	16,0
1D, DD 5D	Metric standpipe	25,0	25,0	25,0	25,0	25,0	16,0	16,0	10,0	10,0	10,0
CW, NW	High pressure cleaning hose connection					40,0					
PW	High pressure cleaning hose connection			22,5							

Fitting end connection	Description	Metric tube size in mm • Very light series – LL									
		Maximum working pressure (MPa) – safety factor 4:1									
		8	10	12	15	18	22	28	35	42	50
C0	DIN 20066:2002-10 swivel female DKLL						6,3	6,3	6,3	6,3	4,0











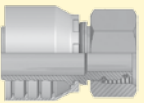
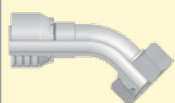

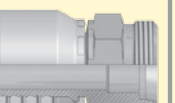

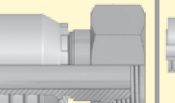

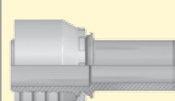
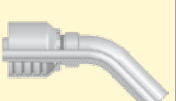

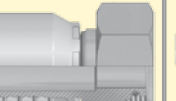

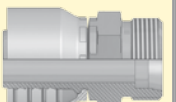
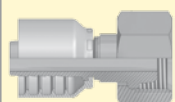
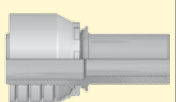
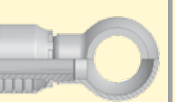





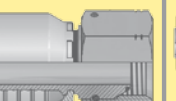

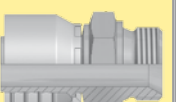
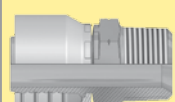
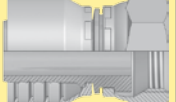
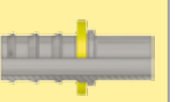
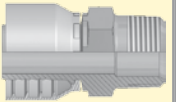
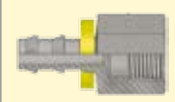
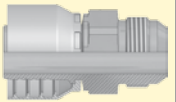
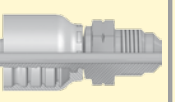
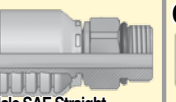
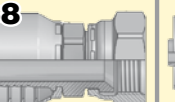
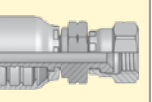
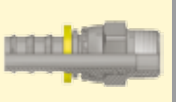
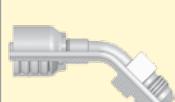

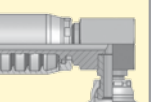
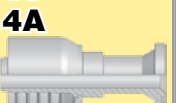
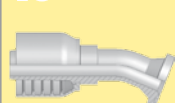

Fitting end connection	Description	Metric tube size in mm • Metric										
		Maximum working pressure (MPa) – safety factor 4:1										
		6	8	10	12	14	16	18	20	22	25	27
49	Banjo Union (DIN 7642)	20,0	20,0	20,0	20,0	20,0	20,0	20,0	20,0	20,0	20,0	
V2	Banjo soft seal with metric bolt				25,0	25,0		21,5		21,5		20,0





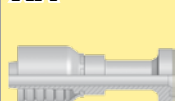



Fitting end connection	Description	Metric tube size in mm • Heavy series – S									
		Maximum working pressure (MPa) – safety factor 4:1									
		6	8	10	12	14	16	20	25	30	38
C6, C7, C8	Swivel female	63,0	63,0	63,0	63,0	63,0	40,0	40,0	40,0	25,0	25,0
C9, 0C, 1C	Swivel female DIN 20066:2002-10 with O-ring, Form P	63,0	63,0	63,0	63,0	63,0	42,0	42,0	42,0	42,0	42,0
D2	Male stud	63,0	63,0	63,0	63,0	63,0	42,0	42,0	42,0	42,0	42,0
3D	Metric standpipe	63,0	63,0	63,0	63,0	63,0	40,0	40,0	40,0	25,0	25,0

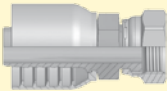
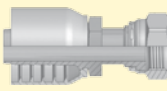
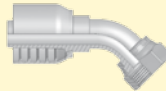
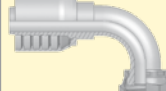

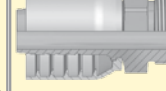

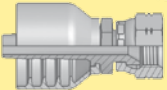
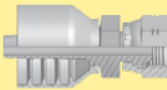
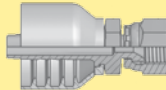

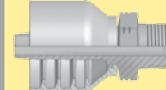
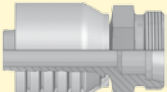

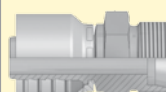
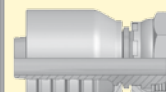
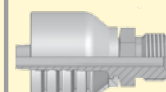
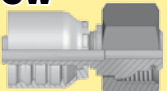
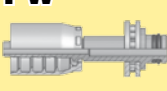
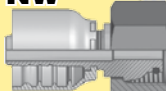

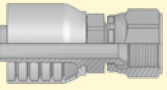

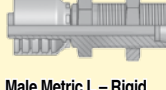
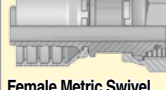

Fitting end connection	Description	Metric tube size in mm • French gas series				
		Maximum working pressure (MPa) – safety factor 4:1				
		13	17	21	27	33
F2	Swivel female 90° Elbow	36,0	27,0	25,5	20,0	17,0
F4	Swivel female (Ball Nose)	36,0	27,0	25,5	20,0	17,0
FG	Male stud	36,0	27,0	25,5	20,0	17,0
GE	Metric standpipe	36,0	27,0	25,5	20,0	17,0

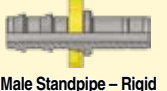
Fitting end connection	Description	Metric tube size in mm • French metric series						
		Maximum working pressure (MPa) – safety factor 4:1						
		10	12	14	18	20	22	30
F9	Swivel female	20,0		14,0	16,0	14,0	13,0	12,2
F6	Male agricultural valves	20,0		14,0	16,0	14,0	13,0	12,2
FA	Male agricultural valves		25,0					

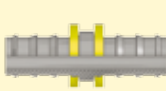
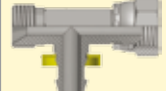
Hose Fittings Overview

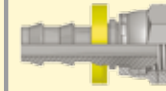
DIN	CA  DKOL	CE  DKOL 45°	CF  DKOL 90°	DO  DKM or DKLL	C0  Female Metric Series LL Swivel (Ball Nose)	C3  DKL	C4  DKL 45°
	C5  DKL 90°	1D  BEL	DD  BEL 45°	5D  BEL 90°	C9  DKOS	0C  DKOS 45°	1C  DKOS 90°
	D2  CES	C6  DKS	3D  BES	49  Metric Banjo	9B  Swivel Female 45° Elbow	9C  Swivel Female 90° Elbow	
	92  DKR	B1  DKR 45	B2  DKR 90	B4  DKR 90 (Compact)	EA  DKOR	EB  DKOR 45°	EC  DKOR 90°
	D9  AGR	91  AGR-K	B5  Female BSP Parallel Pipe - Swivel (Flat Seat)	34  Standpipe			
	01  AGN	02  Female NPTF Pipe Rigid - Straight	03  AGJ	04  Male SAE 45° - Rigid	05  Male SAE Straight Thread with O-Ring - Rigid	06 68  DKJ	08  AGS
13  Male NPTF Pipe Swivel	33  Male JIC 37° - Rigid	37 3V  DKJ 45°	39 3W  DKJ 90°	41 3Y  DKJ 90°L	L9  DKJ 90° M	93  Female JIC 37° - Swivel (Block Type)	
15 4A  SFL	16  SFL 22.5	17 4F  SFL 45°	19 4N  SFL 90	6A  SFS	6F  SFS 45°	6N  SFS 90°	
89  SFL 90 - long	XA  Caterpillar Flange Head	XF  Caterpillar Flange Head 45°	XG  Caterpillar Flange Head 60°	XN  Caterpillar Flange Head 90°			

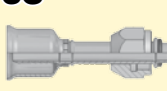
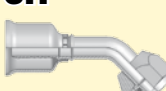
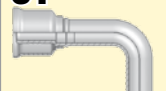
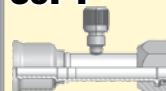
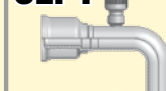
ORFS	JC  ORFS - short	JS  ORFS - long	J7  ORFS 45°	J9  ORFS Female 90	J1  ORFS - extra long	J5  ORFS 90 - long	JM  ORFS Male
	JD  Male ORFS – Bulkhead with Locknut (with O-Ring)						
JIS	FU  GUI	GU  GUO	MU  Female Metric Swivel – (30° Flare)	MZ  Female Metric Swivel – (30° Flare)	UT  Male BSP Taper Pipe Rigid – (60° Cone)		
	French Standard	FG  Male Rigid Gas Series - (24° Cone)	F2  Female Swivel Gas Series	F4  Female Swivel Gas Series - (Ball Nose)	F6  Male Metric (24° Cone)	F9  Swivel Female Metric (Ball Nose)	FA  Metric Male for Agriculture Valves
High Pressure Cleaning		CW  Power Cleaner Connection	PW  Male Kärcher Metric Cleaning Hose Fitting – Rigid	NW  Female Kärcher Metric Cleaning Hose Fitting – (New Design)			

others	XU  Female Metric Swivel – (30° Flare)	XY  Female Metric Swivel – (30° Flare)	DK  Male Metric L – Rigid Bulkhead with Locknut (24° Cone)	DX  Female Metric Swivel (M27x2) O-Ring – Light Series	FF  Metru-Lok Swivel Female	AF  Male BSP Parallel Pipe Rigid – Straight (with O-Ring Seal)	NM  Male BSP Parallel Pipe – L Series – Rigid Straight – ED-Seal
	YW  Male Standpipe – Rigid – Straight – A-Lok	VW121  BSP Swivel Female	82  Push-Lok Union	DP  Metric Swivel Female Tee / Male Stud	DR  Metric Swivel Female Tee	5C  60° Cone Swivel Female	6C  60° Cone Swivel Female – 45° Elbow
	7C  60° Cone Swivel Female – 90° Elbow	5S  Female Tube O-Ring Swivel – Short Pilot	5H  Female Tube O-Ring Swivel – 45° Elbow Short Pilot	5T  Female Tube O-Ring Swivel 90° Elbow Short Pilot	59PT  Male Tube O-Ring Swivel – Long Pilot Charge Port at 180° for R134a	5LPT  Female Tube O-Ring Swivel – 90° Elbow Long Pilot Charge Port at 180° for R134a	T1  Male Refrigerant Tube Mender – Straight (with Nut and Ferrule)

Hose Fittings Nomenclature

End Configuration	Description	Standards	Common Terms
01	Male NPTF Pipe – Rigid – Straight	SAE J476A / J516	AGN
02	Female NPTF Pipe – Rigid – Straight	SAE J476A / J516	
03	Male JIC 37° – Rigid – Straight	ISO12151-5-S	AGJ
04	Male SAE 45° – Rigid – Straight	SAE J516	
05	Male SAE Straight Thread with O-ring – Rigid – Straight	ISO 11926, SAE J516	
06	Female JIC 37° Swivel – Straight	ISO12151-5-SWS	DKJ
06/68	Female – JIC 37° / SAE 45° Dual Flare – Swivel – Straight	ISO12151-5-SWS	DKJ
07	Female NPSM Pipe Swivel		
08	Female SAE 45° – Swivel – Straight	SAE J516	
0C	Female Metric 24° – Heavy Series with O-ring – Swivel – 45° Elbow	ISO 12151-2 – SWE 45°-S	DKOS 45°
0G	Male O-ring Straight		
0L	Male O-ring 90° Elbow		
11	„Ferrul-Fix“		
12	Female Sae Flareless Swivel – Straight (24° Cone)		
13	Male NPTF Pipe Swivel	SAE J476A / J516	
15	SAE Code 61 – Flange Head – Straight	ISO 12151-3-S-L	SFL / 3000 psi
15/4A	SAE Code 61 – Flange Head – Straight / SAE Flange Head 5000 psi	ISO 12151-3-S-L	SFL
16	SAE Code 61 – Flange Head – 22.5° Elbow	ISO 12151-3-E22ML	SFL 22.5° / 3000 psi
17	SAE Code 61 – Flange Head – 45° Elbow	ISO 12151-3 – E45 – L	SFL 45° / 3000 psi
17/4F	SAE Code 61 – Flange – 45° Elbow – 45° Elbow (5000 psi)	ISO 12151-3 – E45S – L	SFL 45°
18	SAE Code 61 Flange – 67.5° Elbow	DIN 20078 R	SFL 67.5°
19	SAE Code 61 – Flange Head – 90° Elbow	ISO 12151-3 – E– L	SFL 90° / 3000 psi
19/4N	SAE Code 61 – Flange Head – 90° Elbow (5000 psi)	ISO 12151-3-E-L	SFL 90°
1C	Female Metric 24° – Heavy Series with O-ring – Swivel – 90° Elbow	ISO 12151-2-SWE-S	DKOS 90°
1D	Metric Standpipe – Light Series – Rigid – Straight	ISO 8434-1	BEL
1L	Male NPTF Pipe Swivel – 90° Elbow		
26	SAE Code 61 Flange – 30° Elbow		SFL 30°
27	SAE Code 61 Flange – 60° Elbow		SFL 60°
28	SAE Male Inverted 45° Elbow		
33	Male JIC 37° – Rigid – 45° Elbow	ISO 12151-5	AGJ 45°
34	Inch Standpipe (Brass)		
37	Female JIC 37° – Swivel – 45° Elbow	ISO 12151-5-SWE 45°	DKJ 45°
37/3V	Female JIC 37° /SAE 45° – Dual Flare – Swivel Female 45° Elbow	ISO 12151-5-SWE 45°	DKJ 45°
39	Female JIC 37° – Swivel – 90° Elbow	ISO 12151-5-SWES	DKJ 90°
39/3W	Female JIC 37° / SAE 45° – Dual Flare – Swivel Female 90° Elbow	ISO 12151-5-SWES	DKJ 90°
3D	Metric Standpipe – Heavy Series – Rigid – Straight	ISO 8434-1	BES
3V	Female JIC 37°/SAE – 45° Swivel – 45° Elbow		DKJ 45°
3W	Female JIC 37°/SAE – 45° Swivel – 90° Elbow		DKJ 90°
3Y	Female JIC 37°/SAE – 45° Swivel – 90° Elbow (Long)		DKJ 90°
41	Female JIC 37° Swivel – 90° Elbow (Long)		DKJ 90°

End Configuration	Description	Standards	Common Terms
41/3Y	Female JIC 37° / 45° Swivel Female 90° Elbow (Long)	ISO 12151-5-SWEL	DKJ 90°L
45	Male Tube O-ring Swivel – Long Pilot		
49	Metric Banjo – Straight	DIN 7642	
4A	5000 psi SAE Code 61 Flange – Straight		
4F	5000 psi SAE Code 61 Flange – 45° Elbow		
4N	5000 psi SAE Code 61 Flange – 90° Elbow		
59	Female Tube O-ring Swivel – Long Pilot		
59PT	Male Tube O-ring Swivel – Long Pilot	With Charge Port at 180° for R134a	
5C	60° Cone Swivel Female		
5D	Metric Standpipe – Light Series – Rigid – 90° Elbow	ISO 8434-1	BEL 90°
5G	Male Tube O-ring Rigid Port (3 step) Straight		
5GPR	Female Tube O-ring Rigid Port (3 step) Straight	With Charge Port for R12	
5H	Female Tube O-ring Swivel – 45° Elbow – Short Pilot		
5K	Male Tube O-ring Swivel – 90° Elbow – Short Pilot		
5LPR	Female Tube O-ring Swivel – 90° Elbow – Long Pilot		
5LPT	Female Tube O-ring Swivel – 90° Elbow – Long Pilot	With Charge Port at 180° for R134a	
5MPR	Male Tube O-ring Swivel – 90° Elbow – Long Pilot	With Charge Port at 180° for R12	
5MPV	Male Tube O-ring Swivel – 90° Elbow – Long Pilot	With Charge Port at 270° for R134a	
5N	Female Tube O-ring Swivel – 45° Elbow – Long Pilot		
5P	Female Tube O-ring Swivel – 45° Elbow – Long Pilot		
5R	Male Tube O-ring Swivel – 45° Elbow – Short Pilot		
5S	Female Tube O-ring Swivel – Short Pilot		
5T	Female Tube O-ring Swivel – 90° Elbow – Short Pilot		
5V	Female Compressor – Swivel 45° Elbow		
5W	Female Compressor – Swivel 90° Elbow		
5Z	Female Compressor – Swivel 90° Elbow – Block Type		
67	SAE Male Inverted Flare Swivel – 45° Elbow		
68	Female JIC 37° / SAE 45° Swivel		DKJ
69	SAE Male Inverted Flare Swivel – 90° Elbow		
6A	SAE Code 62 – Flange – Straight	ISO 12151-3-S-S	SFS / 6000 psi
6B	SAE Code 62 Flange – 22.5° Elbow		SFS 22.5°
6C	60° Cone Swivel Female – 45° Elbow		
6E	SAE Code 62 Flange – 30° Elbow		SFS 30°
6F	SAE Flange 45° Elbow – Heavy Series	ISO 12151-3 – E45-S	SFS 45° / 6000 psi
6G	SAE Code 62 Flange – 60° Elbow		SFS 60°
6N	SAE Code 62 Flange Head – 90° Elbow	ISO 12151-3 – E-S	SFS 90° / 6000 psi
77	Female SAE 45° Swivel – 45° Elbow		
79	Female SAE 45° Swivel – 90° Elbow		
7C	60° Cone Swivel Female – 90° Elbow		
7D	Male Standpipe Metric S – Rigid – 90° Elbow		BES 90°
82	Push-Lok® Union		
82	Push-Lok® Union		

End Configuration	Description	Standards	Common Terms
89	SAE Code 61 Flange – 90° Elbow (Long) – Standard Series	DIN 20 078 R	
91	Male BSP Taper Pipe – Rigid – Straight	BS5200	AGR-K
92	Female BSP Parallel Pipe – Swivel – Straight (60° Cone)	BS5200-A	DKR
93	Female JIC 37° – Swivel – 90° Elbow (Block Type)		
9B	Metric – Swivel Female 45° Elbow – Light Series		
9C	Light Series Metric Swivel Female 90° Elbow		
AF	Male BSP Parallel Pipe – Rigid – Straight (with O-ring Seal)		
B1	Female BSP Parallel Pipe – Swivel – 45° Elbow (60° Cone)	BS 5200-D	DKR 45°
B2	Female BSP Parallel Pipe – Swivel – 90° Elbow (60° Cone)	BS 5200-B	DKR 90°
B4	Female BSP Parallel Pipe – Swivel – 90° Elbow Block Type (60° Cone)	BS 5200-E	DKR 90°
B5	Female BSP Parallel Pipe – Swivel – Straight (Flat Seat)		
C0	Female Metric – Very Light Series LL – Swivel – Straight (Ball Nose)		DKM
C3	Female Metric – Light Series – Swivel – Straight (Ball Nose)		DKL
C4	Female Metric – Light Series – Swivel – 45° Elbow (Ball Nose)		DKL 45°
C5	Female Metric – Light Series – Swivel – 90° Elbow (Ball Nose)		DKL 90°
C6	Female Metric – Heavy Series – Swivel – Straight (Ball Nose)		DKS
C7	Female Metric Swivel – 45° Elbow “Heavy” Series	DIN 20 078	DKS 45°
C8	Female Metric Swivel – 90° Elbow “Heavy” Series	DIN 20 078	DKS 90°
C9	Female Metric 24° – Heavy Series with O-ring – Swivel – Straight	ISO 12151-2-SWS-S	DKOS
CA	Female Metric 24° – Light Series with O-ring – Swivel – Straight	ISO 12151-2-SWS-L	DKOL
CE	Female Metric 24° – Light Series with O-ring – Swivel – 45° Elbow	ISO 12151-2-SWE 45°-L	DKOL 45°
CF	Female Metric 24° – Light Series with O-ring – Swivel – 90° Elbow	ISO 12151-2-SWE-L	DKOL 90°
CW	Power Cleaner Connection		
D0	Male Metric 24° – Light Series – Rigid – Straight	ISO 12151-2-S-L	CEL
D2	Male Metric 24° – Heavy Series – Rigid – Straight	ISO 12151-2-S-S	CES
D9	Male BSP Parallel Pipe – Rigid – Straight (60° Cone)	BS5200	AGR
DD	Metric Standpipe – Light Series – Rigid – 45° Elbow		BEL 45°
DE	Double Banjo Union		
DK	Male Metric L – Rigid – Bulkhead with Locknut (24° Cone)		
DP	Metric Swivel Female Tee / Male Stud		
DR	Metric Swivel Female Tee		
DS	Metric Swivel Female Tee / Standpipe		
DW	Female Metric Swivel „Light“ Series		TGL
DX	Female Metric Swivel (M27x2) O-ring – Light Series		
EA	BSP Swivel Female with O-ring (60° Cone)	BS 5200, ISO 12151-6	DKOR
EB	BSP Swivel Female with O-ring – 45° Elbow (60° Cone)	BS 5200, ISO 12151-6	DKOR 45°
EC	BSP Swivel Female with O-ring – 90° Elbow (60° Cone)	BS 5200, ISO 12151-6	DKOR 90°
F2	Female French Swivel Female – Gas Series 90° Elbow		

End Configuration	Description	Standards	Common Terms
F4	Female French Gas Series – Swivel – Straight (Ball Nose)		
F6	French Male Metric Series (24° Cone)		
F9	French Swivel Female Metric Series – (Ball Nose)		
FA	Metric Male For Agriculture Valves		
FB	French Metric		
FF	Metru-Lok Swivel Female		
FG	Male French Gas Series – Rigid – Straight (24° Cone)		
FU	Female BSP Parallel Pipe – Swivel – Straight (30° Flare)	ISO 228-1, JIS B8363	GUI
GE	French Gas Standpipe		
GU	Female BSP Parallel Pipe – Swivel – Straight (60° Cone)	ISO 228-1, JIS B8363	GUO
J1	Female ORFS – Swivel – 90° Elbow – Long Drop	ISO 12151-1 – SWEL, SAE J 516	ORFS 90° L
J5	Female ORFS – Swivel – 90° Elbow – Medium Drop	ISO 12151-1 – SWEM	ORFS 90° M
J7	Female ORFS – Swivel – 45° Elbow	ISO 12151-1 – SWE 45°, SAE J516	ORFS 45°
J9	Female ORFS – Swivel – 90° Elbow – Short Drop	ISO 12151-1 – SWES, SAE J516	ORFS 90°
JC	Female ORFS – Swivel – Straight – Short	ISO 12151-1 – SWSA, SAE J516	ORFS
JD	Male ORFS – Bulkhead with Locknut – Straight (with O-ring)	ISO 12151-1 – SAE J516	
JM	ORFS Male	ISO 12151-1-S, SAE J516	
JS	ORFS Swivel Female (Long)	ISO 12151-1-SWSB, SAE J516	ORFS
L9	Female JIC 37° – Swivel – 90° Elbow – Medium Drop	ISO 12151-5-SWEM	DKJ 90° M
MU	Female Metric – Swivel – Straight (30° Flare)	JIS B8363	MU
MZ	Female Metric – Swivel – 9 0° Elbow (30° Flare)	JIS B8363	
NM	Male BSP Parallel Pipe – L Series – Rigid – Straight – ED-Seal	ISO 1179	
NW	Female Kärcher Metric Cleaning Hose Fitting – Swivel – Straight	(New Design)	
PW	Male Kärcher Metric Cleaning Hose Fitting – Rigid – Straight		
S2	Female NPTF Pipe Swivel		
S5	Male Tube O-ring Swivel – Short Pilot		
T1	Male Refrigerant Tube Mender – Straight (with Nut and Ferrule)		
UT	Male BSP Taper Pipe – Rigid – Straight (60° Cone)	JIS B 8363-R	
V1	Ermeto standard Pressuree Banjo – Straight (with UNF Bolt and O-ring)		
VW	Push In Connector	(VW-Standard 39-V-16619)	
VW121	BSP Swivel Female	(VW-Norm 39-V-16631)	
VW39D	Push In Connector	(VW-Standard 39D-1401)	
WKS	Rubber hand grip		
XA	Caterpillar® Flange Head – Straight		
XF	Caterpillar® Flange Head – 45° Elbow		
XG	Caterpillar® Flange Head – 60° Elbow		
XN	Caterpillar® Flange Head – 90° Elbow		
XU	Female Metric – Swivel – Straight (30° Flare)	JIS B8363	
XY	Female Metric – Swivel – 90° Elbow (30° Flare)	JIS B8363	
YW	Male Standpipe – Rigid – Straight – A-Lok	Metric Size Tube O.D. with Vee Notch	

Classification Body Type Approvals

Description (1)-(14) see Ab-11

	Hose	Reinforcement	Norm EN/ISO	GL (1)	DNV (2)	RINA (3)	DB/DIN 5510 (4)	LR (5)	MOD (6)	ABS (7)	DOT (8)	USCG (9)	MSHA (10)	BV (11)	NF (12)	BS 6853 (13)	MarED (14)
Low Pressure Push-Lok Hoses	801	1 braid, fibre															
	804	1 braid, fibre															
	821FR	1 braid, fibre															
	830M	1 braid, fibre															
	831	1 braid, fibre															
	836	1 braid, fibre											X				
	837BM	1 braid, fibre															
	837PU	1 braid, fibre															
	838M	1 braid, fibre															
Low Pressure Specialty Hoses	201	1 braid, wire	SAE 100 R5 / SAE J1402 All								X						
	206	1 braid, wire	SAE 100 R5 / SAE J1402 All				X				X						
	213	1 braid, wire	SAE J1402 All								X						
	221FR	1 braid, wire	SAE J1527 Typ R3	X	X					X		X	X				
	285	1 braid, wire	SAE J2084 Typ C														
	293	1 braid, fibre	SAE J1402 All								X						
	601	2 braids, fibre	SAE 100 R3									H	X				
	611HT	1 braid, fibre	EN 854-R6														
	681DB	2 braids, fibre	EN 854-2TE				X								X	X	
Medium Pressure	301SN	2 braids, wire	EN 853-2SN											X			
	302	2 braids, wire	EN 853-2SN / ISO 1436		X					X		X					
	304	2 braids, wire	SAE 100 R2 AT														
	402	1 braid, wire															
	421RH	1 braid, wire	EN 853-1SN				X								X	X	
	421SN	1 braid, wire	EN 853-1SN									X	X				
	421WC	1 braid, wire	SAE 100 R1 AT														
	422	1 braid, wire	EN 853-1SN / ISO1436		X					X		X					
	424	1 braid, wire	SAE 100 R1 AT														
	426	1 braid, wire	SAE 100 R1 AT							X		H	X				
	436	2 braids, wire	SAE 100 R16		X		X			X		H	X				
	441	1 braid, wire	SAE 100 R16														
	441RH	1 braid, wire	SAE 100 R16				X								X	X	
	451TC	1 braid, wire	SAE 100 R17							X		H	X				
	461LT	2 braids, wire	EN 857-2SC														
	462	2 braids, wire	EN 857-2SC	X	X	X	X	X						X			
	462ST	2 braids, wire	EN 857-2SC														
	463	2 braids, wire															
	471TC	2 braids, wire	EN 857-2SC		X						X		H	X			
	472TC	1 braid, wire	EN 857-2SC		X						X						
	492	1 braid, wire	EN 857-1SC	X	X	X	X	X							X		
	492ST	1 braid, wire	EN 857-1SC														
	493	1 braid, wire															
	692	1/2 braids, wire	SAE 100 R17														
692Twin	1/2 braids, wire	SAE 100 R17															
811	1 braid, 1 steel spiral	SAE 100 R4										H	X				
881	1 braid, 1 steel spiral	SAE 100 R4															
High Pressure	371LT	3 braids, wire															
	372	3 braids, wire		X	X		X	X						X			X
	372RH	3 braids, wire					X								X	X	
	372TC	3 braids, wire											X				
	701	4 spiral, wire	EN 856-4SP														
	721TC	4 spiral, wire	SAE 100 R12										X				
	731	4 spiral, wire	EN 856-4SH											H			
	774	4 spiral, wire															
	781	4/6 spiral, wire	SAE 100 R13														
	P35	6 spiral, wire	SAE 100 R13				X			X		X					
	791TC	4/6 spiral, wire	SAE 100 R15		X					X		X	X				
792TC	4/6 spiral, wire	SAE 100 R15		X					X		H	X					

Classification Bodies

The mission of classification bodies is to contribute to the development and implementation of technical standards for the protection of life, property and the environment.

(1) Germanischer Lloyd (GL)

German independent organisation of technical experts approving products for the German merchandise marine and the energy sector - GLIS (oil and gas, wind energy, etc...)

(2) Det Norske Veritas (DNV)

Norwegian service company for managing risk in ship classification, off-shore industry, etc...

(3) RINA (Registro Italiano Navale)

Italian company offering certification, verification, control, assistance in marine, energy & process, transport and industry.

(4) Deutsche Bahn (DB) - German Standard DIN 5510 - Part 2

The German rail authority (DB) approves the behaviour of the products in respect to their resistance to burning and their ability to self extinguish after a flaming, according to the DIN 5510-2 requirements.

(5) Lloyd's Register (LR)

English independent organisation providing certification around the world. Marine services, Rail services and Energy services are their main activities.

(6) Ministry of Defence (MOD)

British ministry of defence providing approvals for military equipment according to the MOD DefStan (Defence Standard) 47-2 specification.

(7) American Bureau of Shipping (ABS)

US company providing rules for safety in the marine environment.

(8) US Department of Transportation (DOT)

USA organisation providing certifications to ensure a fast, safe, efficient, accessible and convenient transportation system in this country.

(9) US Coast Guard (USCG)

Provides maritime safety, law enforcement, recreational boating safety, and environmental protection information for merchant mariners. The approved hoses are not accepted for all applications automatically. If the column contains "H", the hose is accepted for Hydraulic Systems only and not for Fuel and lube systems.

(10) Mine Safety and Health Administration (MSHA)

US organisation for safety in the mining industry

(11) Bureau Veritas (BV)

Bureau Veritas is today the most widely recognized certification body in the world, offering solutions in the key strategic fields of operations: Quality, Health & Safety, Environment and Social Responsibility.

(12) French Standard NF F-16-101/102 (NF)

Tests the fire behaviour and fire effluents of the hose cover material for rail applications.

(13) British Standard (BS 6853)

Tests the fire behaviour and fire effluents of the hose cover material for rail applications.

(14) MarED

MarED is the Group of Notified Bodies for the Implementation of the Marine Equipment Directive.

EN	European Norm
ISO	International Organisation for Standardization
SAE	Society of Automotive Engineers (US organisation)

Conversion Chart

	Unit	Base Unit	Conversion Unit	Factor
Length	1 inch	in	mm	25,4
	1 millimetre	mm	in	0,03934
	1 foot	ft	m	0,3048
	1 metre	m	ft	3,28084
Area	1 square-inch	sq in	cm ²	6,4516
	1 square-centimetre	cm ²	sq in	0,1550
Volume	1 gallon (UK)	gal	l	4,54596
	1 litre	l	gal (UK)	0,219976
	1 gallon (US)	gal	l	3,78533
	1 litre	l	gal (US)	0,264177
Weight	1 pound	lb	kg	0,453592
	1 kilogramme	kg	lb	2,204622
Torque	1 pound foot	lb • ft	kg • m	1,488164
	1 newton metre	kg • m	lb • ft	0,671969
Pressure	1 pound per square inch	psi	bar	0,06895
	1 bar	bar	psi	14,5035
	1 pound per square inch	psi	MPa	0,006895
	1 mega pascal	MPa	psi	145,035
	1 kilo pascal	kPa	bar	0,01
	1 bar	bar	kPa	100
	1 mega pascal	MPa	bar	10
	1 bar	bar	MPa	0,1
Velocity	1 foot per second	ft / s	m / s	0,3048
	1 metre per second	m / s	ft / s	3,28084
Flow rate	1 gallon per minute (UK)	gal / min.	l / min.	4,54596
	1 litre per minute	l / min.	gal / min. (UK)	0,219976
	1 gallon per minute (US)	gal / min.	l / min.	3,78533
	1 litre per minute	l / min.	gal / min. (US)	0,264178
Temperature	Fahrenheit degree	°F	°C	5/9 • (°F-32)
	Celsius degree	°C	°F	°C • (9 / 5) +32

(UK) Unit of United Kingdom
 (US) Unit of USA

Temperature / Pressure Chart

Reference 201, 206, 213 and 293 hose.

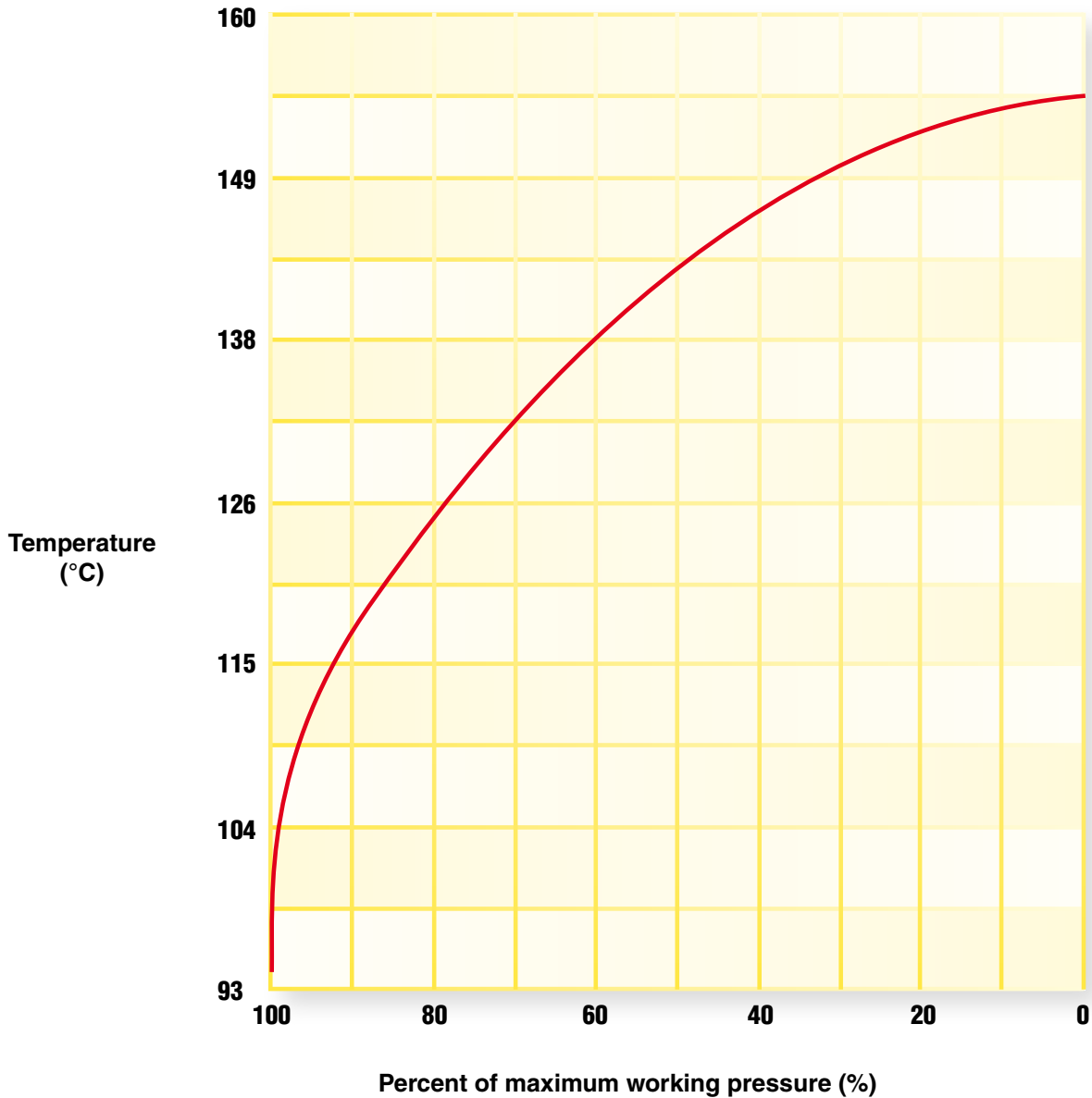

EXAMPLE: 201-8 hose to be used at 121 °C

Maximum Working Pressure up to 100 °C	x	Multiplication Factor from Chart	=	Maximum Working Pressure at 121 °C
13,8 MPa (2000 psi)	x	85%	=	11,7 MPa (1700 psi)

Flow Capacity Nomogram

Flow Capacities of Parker Hose at Recommended Flow Velocities

The chart below is provided as an aid in the determination of the correct hose size.

Example: at 10 gallons per minute (gal/min), what is the proper hose size within the recommended velocity range for pressure lines?

Locate 10 gallons per minute in the left-hand column and 20 feet per second in the right-hand column (the maximum recommended velocity range for pressure lines). Lay a straight line across these two points. The inside diameter shown in the centre column is above -6 so we have to use -8 (1/2").

For suction hose, follow the same procedure except use recommended velocity range for intake lines in the right-hand column.

where: Q = flow in gallons per minute (gal/min & l/min)
 V = velocity in feet per second (f/s & m/s)
 d = hose inside diameter (mm & dash size)

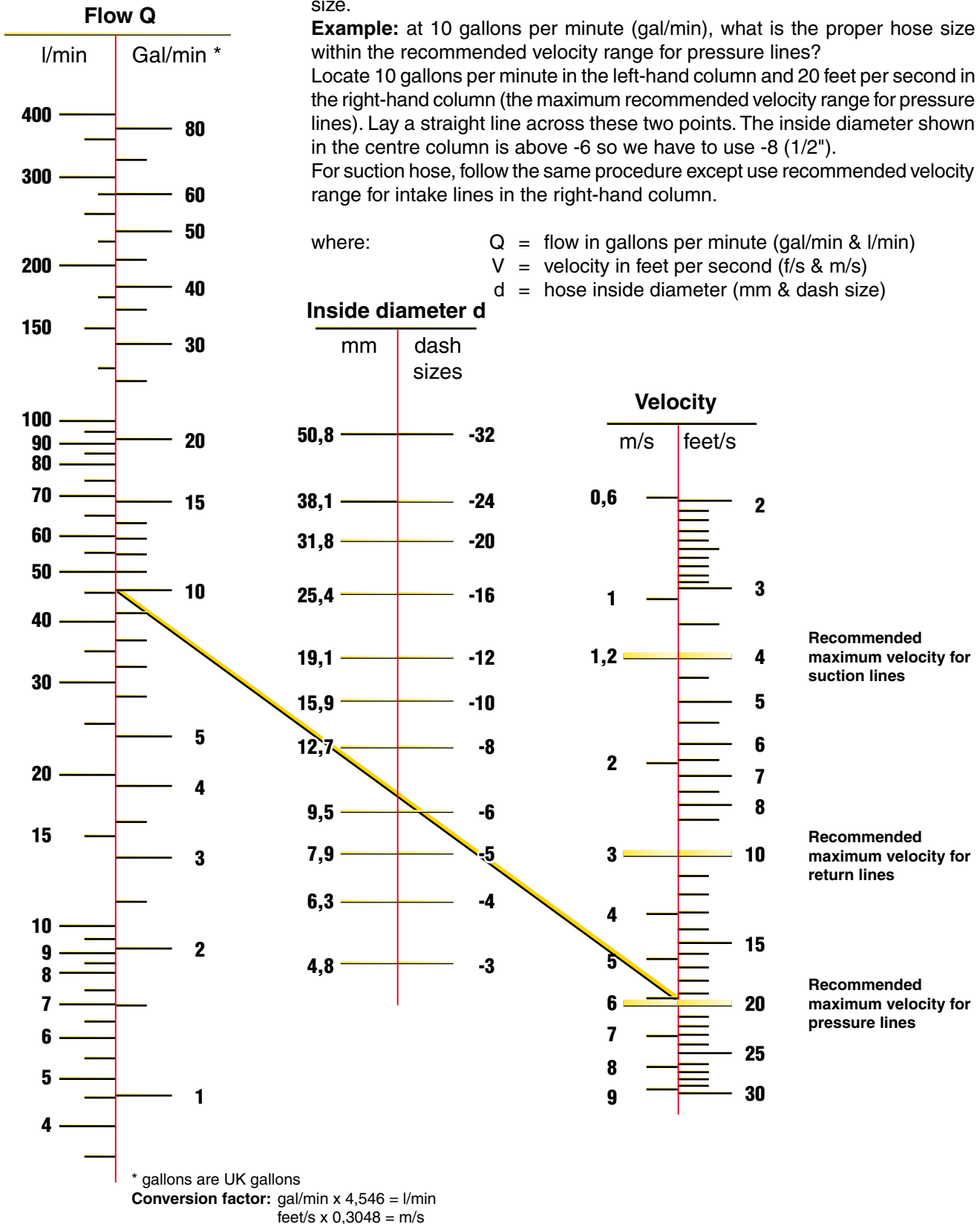

* Recommended velocities are according to hydraulic fluids of maximum viscosity 315 S.S.U. at 38°C working at roomtemperature within 18° and 68°C.

The Correct Method to Fit Female Swivel Ends

To ensure a leakproof seal between swivel female hose ends shown in this catalogue and the appropriate adaptors it is necessary to follow the procedure below which is different from hydraulic tube assembly.

Flats From Wrench Resistance (FFWR)

Parker's recommended assembly method for JIC 37° flare, SAE 45° flare and ORFS swivel female is Flats From Wrench Resistance (FFWR). The torque values assigned by size are for reference only, and are only applicable to Parker system components using the FFWR method with trivalent chromate passivation on zinc plating of carbon steel components without lubrication.

Metal-to-metal seal

Screw the nut up hand tight and then tighten further with a spanner according to the values mentioned in the table below. Ensure that in all cases the hose is correctly aligned before tightening the nut onto the corresponding adaptor.

Spanner torque values

Metric swivel female

Thread metric	Tube O.D.	Nm	
		nominal	min. - max.
M 12x1,5	06L	16	15 - 17
M 14x1,5	08L	16	15 - 17
M 16x1,5	10L	26	25 - 28
M 18x1,5	12L	37	35 - 39
M 22x1,5	15L	47	45 - 50
M 26x1,5	18L	89	85 - 94
M 30x2	22L	116	110 - 121
M 36x2	28L	137	130 - 143
M 45x2	35L	226	215 - 237
M 52x2	42L	347	330 - 363
M 14x1,5	06S	26	25 - 28
M 16x1,5	08S	42	40 - 44
M 18x1,5	10S	53	50 - 55
M 20x1,5	12S	63	60 - 66
M 22x1,5	14S	79	75 - 83
M 24x1,5	16S	84	80 - 88
M 30x2	20S	126	120 - 132
M 36x2	25S	179	170 - 187
M 42x2	30S	263	250 - 275
M 52x2	38S	368	350 - 385

BSP swivel female

Thread BSP	size	Nm	
		nominal	min. - max.
G1/4	-4	20	15 - 25
G3/8	-6	34	27 - 41
G1/2	-8	60	42 - 76
G5/8	-10	69	44 - 94
G3/4	-12	115	95 - 135
G1	-16	140	115 - 165
G1.1/4	-20	210	140 - 280
G1.1/2	-24	290	215 - 365
G2	-32	400	300 - 500

Note

Values given in tables are typical to achieve the recommended assembly methods when fitting material is steel zinc plated. For other materials different values will be applicable. (see our recommendations for other materials on this page)

JIC 37° swivel female

Thread UNF	size	Flats From Wrench Resistance (FFWR)	Swivel Nut Torque Nm (Ref)
7/16-20	-4	2	18
1/2-20	-5	2	23
9/16-18	-6	1-1/2	30
3/4-16	-8	1-1/2	57
7/8-14	-10	1-1/2	81
1.1/16-12	-12	1-1/4	114
1.5/16-12	-16	1	160
1.5/8-12	-20	1	228
1.7/8-12	-24	1	265
2.1/2-12	-32	1	360

ORFS swivel female

Thread UNF	size	Flats From Wrench Resistance (FFWR)	Swivel Nut Torque Nm (Ref)
9/16-18	-4	1/2 to 3/4	26
11/16-16	-6	1/2 to 3/4	42
13/16-16	-8	1/2 to 3/4	57
1-14	-10	1/2 to 3/4	85
1.3/16-12	-12	1/3 to 1/2	122
1.7/16-12	-16	1/3 to 1/2	156
1.11/16-12	-20	1/3 to 1/2	200
2-12	-24	1/3 to 1/2	256
2-1/2x12	-32	-	-

Note: The assembly torques listed are higher than the test torques published in SAE J1453.

The torque values for other materials are as follows:

- Brass fittings and adapters
 - 65 % of the torque value for steel.
- Stainless steel and Monel
 - Use 5% higher than listed for steel.
 - Threads to be lubricated for these materials.
- Dissimilar metals
 - Use torque value designated for the lower of the two metals.
- All fittings are dry except as noted above.

Chemical Resistance Table

Warning ! This chemical compatibility guide must not be used in conjunction with any other compatibility guides from previous or future catalogue editions, bulletins or publications. Incorrect use of these charts could result in death, personal injury or property damage.

Hose Selection by Medium and Hose Type

This hose compatibility chart is a ready reference of Parker hose compatibility with various fluid media. It is intended as a guide to **chemical compatibility** with **inner tube materials and assembly lubricants applied internally**.

The outer cover of the hose is intended to protect the reinforcement layer(s) from mechanical influences (abrasion, weathering etc), as such the **cover compounds are not designed to exhibit the same chemical resistance as the tube compounds**. Hose Division Technical Department should be consulted about the compatibility of the cover should the application involve the extended exposure or immersion in a liquid.

The specific recommendations are based upon field experience, the advice of various polymer or fluid suppliers, and specific laboratory experiments. It must be stressed, however, that this information is offered only as a guide. Final hose selection depends also upon pressure, fluid temperature, ambient temperature, and special requirements or variations, which may not be known by Parker Hannifin. Legal and other regulations must be followed with particular care.

Where an external compatibility problem may occur, or for fluids not listed, we encourage you to first contact the fluid manufacturer for a recommendation prior to contacting your Parker Hannifin Field Representative or the Technical Department, Hose Products Division Europe (HPDE@Parker.com)

Use the Chart as Follows:

1. Locate medium to be carried using the Chemical Resistance Table on the following pages.
2. Select suitability of hose and fitting material from the table based on the letter rating in the table. See resistance rating key below for explanation of compatibility ratings. See list of numerals below for an explanation when a numeral, or a numeral and a letter rating are present in the table.
3. The Column headings on the Chemical Resistance Table, I, II, III, IV, V, refer to specific groups of hoses.
4. Locate hose part number under Column I, II, III, IV, V, VI from the list below.
5. For fitting material availability refer to appropriate fitting section of catalogue.
6. Check hose specifications in this catalogue. Contact Hose Division Technical Department on any items not catalogued.

Resistance Rating Key

- A = Preferred, good to excellent with little or no change in physical properties.
- F = Fair, marginal or conditional with noticeable effects on physical properties.
- X = Unsuitable, severe effects on physical properties.
- ~ = No rating, insufficient information.

Numerals

1. For air or gaseous applications above 250 PSI (1,7 MPa), the cover should be pin pricked.
2. Legal and insurance regulations must be considered. Contact HPDE Technical Department for more information.
3. Push-Lok hoses (801, 804, 821, 821FR, 831, 836, 837BM, 837PU, 830M, 838M) are not recommended for any type of fuel.
4. Use 285, 235 or 244 hoses. The compatibility of the systems refrigeration oil with these hoses needs to be evaluated on a case by case basis. Contact HPDE Technical Department for more information. Do not use mineral oil or Alkyl Benzene refrigeration oils with 244 hose. Chemical compatibility does not imply low permeation.
5. 65 °C (150 °F) maximum.
6. Satisfactory at some concentrations and temperatures, unsatisfactory at others.
7. For phosphate ester fluids use 304, 424, 774 or 804 hoses.
8. Acceptable for flushing hose assemblies.
9. 221FR hose recommended.
10. For dry air applications, hoses with inner tubes from columns IV, and V are preferred. See hose specifications for maximum recommended temperatures with air.
11. 100 °C (212 °F) maximum.
12. 121 °C (250 °F) maximum.
13. Hoses for gas application are available from Parker. Please contact the Technical Department for more information about the products as well as the legal application requirements.
14. Hoses for gas application are available from Parker. Please contact the Technical Department for more information about the products as well as the legal application requirements.
15. 70 °C maximum for hoses 801, 837BM, 837PU
16. No rating / insufficient information about chemical compatibility for hoses 801, 837BM, 837PU.

Hose Types

<u>Column I:</u> 201, 225, 601, 701, 721, 721TC, 731, 77C, P35, 781, 791TC, 881	<u>Column IV:</u> 206, 213, 226, 266, 293, 426, 436, 611HT, 821FR, 836, 801*, 837BM*, 837PU*
<u>Column II:</u> 371LT, SS25UL, 421WC, 431, 441, 441RH, 451TC, 451ST, 461LT, 463, 471TC, 471ST, 493, 681DB, 811	<u>Column V:</u> 304, 424, 604, 774, 804
<u>Column III:</u> 221FR, 301SN, 302, 372, 372RH, 372TC, 402, 421RH, 421SN, 422, 462, 462ST, 472TC, 492, 492ST, 692, 692Twin, 772TC, 772ST, 782TC, 782ST, 792TC, 792ST, 821, 831	<u>Column VI:</u> 830M, 838M

Note: * See Numeral 15,16

Caution: The fluid manufacturer's recommended maximum operating temperature for any specific name-brand fluid should be closely observed by the user. Specific name brand fluids can vary greatly between manufacturers even though they are considered to be from the same family or-of fluids. Using fluids above the manufacturers maximum recommended temperature can cause the fluid to break down, creating by-products that can be harmful to elastomers or other materials used in the system. When selecting a hose type, both the fluid manufacturer and hose manufacturers maximum temperature limit must be taken into consideration, with the lower of the taking precedence.

Medium	I	II	III	IV	V	VI	STEEL	BRASS	SS
3M FC-75	A	A	A	A 16	A	A	A	A	A
Acetic Acid	X	X	X	A 16	6	X	X	X	A
Acetone	X	X	X	A 16	A	X	A	A	A
Acetylene	X	X	X	X	X	-	-	-	-
AEROSHELL Turbine Oil 500 (See MIL-L-23699)	X	X	F	X	X	-	A	A	A
Air	A, 1, 10	A, 1, 10	A, 1, 10	A 1, 10	A, 1, 10	A	A	A	A
Air (dry)	X	F, 1, 10	F, 1, 10	A 1, 10	A, 1, 10	A	A	A	A
Alcohol (Methanol-Ethanol)	F	F	F	A 16	F	-	F	A	A
Ammonia (Anhydrous)	X	X	X	X	X	-	X	X	X
Ammonium Chloride	A	A	A	A 16	A	A	X	X	X
Ammonium Hydroxide	F	F	F	A 16	A	X	F	X	A
Ammonium Nitrate	A	A	A	A 16	A	-	F	X	A
Ammonium Phosphate	A	A	A	A 16	A	-	X	X	F
Ammonium Sulfate	A	A	A	A 16	A	-	F	X	F
Amoco 32 Rykon	X	A	A	F 15	X	A	A	A	A
Ampol PE 46	X	X	X	X	A, 7	F	A	A	A
AMSOIL Synthetic ATF	F	A	A	A 16	X	F	A	A	A
Amyl Alcohol	X	X	X	A 16	F	-	X	A	A
Anderol 495,497,500,750	X	X	X	A 16	X	X	A	A	A
Aniline	X	X	X	A 16	A	X	A	X	A
Animal Fats	X	F	F	A 16	F	-	6	6	A
Aquacent Light, Heavy	X	A	A	X	X	A	A	A	A
Argon	A	A	A	A	A	A	A	A	A
Aromatic 100,150	X	F	F	-	X	F	A	A	A
Arrow 602P	A	A	A	A 15	X	A	A	A	A
Asphalt	X	F	F	F 15	X	A	F	F	A
ASTM #3 Oil	F	F	F	A 16	X	-	A	A	A
ATF-M	F	A	A	A 15	X	A	A	A	A
Automotive Brake Fluid	X	X	X	X	-	X	X	X	X
AW 32,46,68	F	A	A	A 15	X	A	A	A	A
BCF	F	F	F	F 16	-	-	A	A	A
Benz Petraulic 32,46,68,100,150,220,320,460	F	A	A	A 15	X	A	A	A	A
Benzene, Benzol	X	X	X	A 16	X	F	A	A	A
Benzgrind HP 15	-	A	A	A 16	X	-	A	A	A
Benzine	X	X	X	F 16	X	-	A	A	A
Biodegradable Hydraulic Fluid 112B	X	A	A	X	-	-	A	A	A
Borax	F	F	F	A 16	A	-	F	A	A
Boric Acid	A	A	A	X	A	X	X	6	A
Brayco 882	X	A	A	A 16	X	-	A	A	A
Brayco Micronic 745	X	X	A	F 15	X	A	A	A	A
Brayco Micronic 776RP	F	A	A	F 15	X	A	A	A	A
Brayco Micronic 889	X	F	F	-	X	-	A	A	A
Brine	F	F	F	A 16	A	-	X	F	F
Butane		See 2 & 13				F	A	A	A
Butyl Alcohol, Butanol	F	F	F	A 16	F	-	F	F	A
Calcium Chloride	A	A	A	A 16	A	-	F	F	X
Calcium Hydroxide	A	A	A	A 16	A	-	A	A	A
Calcium Hypochlorite	X	X	X	A 16	A	-	X	F	X
Calibrating Fluid	A	A	A	A 15	X	A	A	A	A
Carbon Dioxide, gas	F	F	F	F 16	6	-	A	A	A
Carbon Disulfide	X	X	X	A 16	X	-	A	F	A
Carbon Monoxide (hot)	F	F	F	A 16	6	-	F	6	A
Carbon Tetrachloride	X	X	X	A 16	X	-	6	6	6
Carbonic Acid	F	F	F	X	F	X	X	X	F
Castor Oil	A	A	A	A 16	A	-	A	A	A
Castrol 5000	X	F	F	A 16	X	X	A	A	A
Cellosolve Acetate	X	X	X	X	A	-	X	X	A
Cellugard	A	A	A	-	A	-	A	A	A
Cellulube 90, 150, 220 300, 550, 1000	X	X	X	-	A	-	A	A	A
Chevron Clarity AW 32, 46, 68	A	A	A	A 15	X	A	A	A	A
Chevron FLO-COOL 180	F	F	F	-	X	-	A	A	A
Chevron FR-8, 10, 13, 20	X	X	X	X	A, 7	F	A	A	A
Chevron Hydraulic Oils AW MV 15, 32, 46, 68, 100	A	A	A	A 15	X	A	A	A	A
Chevron HyJet IV (9)	X	X	X	X	A, 7	F	A	A	A
Citric Acid	F	A	A	X	A	X	X	X	6
Commonwealth EDM 242, 244	A	A	A	-	X	A	A	A	A
CompAir CN300	X	X	X	A 16	X	X	A	A	A
CompAir CS100, 200, 300, 400	X	X	X	A 16	X	X	A	A	A
Coolanol 15, 20, 25, 35, 45	A	A	A	A 16	A	X	A	A	A
Copper Chloride	F	A	A	X	A	-	X	X	X
Copper Sulfate	A	A	A	X	A	-	X	X	F
Cosmolubric HF-122, HF-130, HF-144	X	F	A	X	X	-	A	A	A
Cosmolubric HF-1530	X	F	A	X	X	-	A	A	A
Cottonseed Oil	F	A	A	F 16	X	-	A	A	A
CPI CP-4000	X	X	X	A 16	X	-	A	A	A
Crude Petroleum Oil	F	A	A	A 15	X	A	F	F	A

Medium	I	II	III	IV	V	VI	STEEL	BRASS	SS
CSS 1001 Dairy Hydraulic Fluid	F	A	A	A 16	X	-	A	A	A
Daphne AW32	A	A	A	A 15	X	A	A	A	A
Dasco FR 201-A	A	A	A	-	X	-	A	A	A
Dasco FR150, 200, 310	F	A	A	-	A	-	A	A	A
Dasco FR300, FR2550	X	X	X	-	X	F	A	A	A
Dasco FR355-3	X	F	A	X	X	X	A	A	A
Deicer Fluid 419R	A	A	A	-	-	A	A	A	A
Deionized Water	A	A	A	A 16	A	-	F	F	A
Dexron II ATF	F	A	A	A 15	X	A	A	A	A
Dexron III ATF	X	F, 11	F, 11	A 16, 12	X	-	A	A	A
Diesel Fuel	F, 3	A, 3	A, 3	A 16, 3	X	A(2)	A	A	A
Diester Fluids	X	X	X	A 16	X	X	A	A	A
Dow Corning 2-1802 Sullair (24KT)	-	-	-	F 16	-	-	A	A	A
Dow Corning DC 200, 510, 550, 560, FC126	A	A	A	A 16	-	-	A	A	A
Dow HD50-4	F	F	F	-	-	-	-	-	A
Dow Sullube 32	-	-	-	F 16	-	-	A	A	A
Dowtherm A,E	X	X	X	A 16	X	-	A	A	A
Dowtherm G	X	X	X	X	X	-	A	A	A
Duro AW-16, 31	A	A	A	-	X	-	A	A	A
Duro FR-HD	A	A	A	-	X	-	A	A	A
EcoSafe FR-68	A	A	A	-	X	X	A	A	A
Ethanol	F	F	F	A 16	F	-	F	A	A
Ethers	X	X	X	A 16	X	-	A	A	A
Ethyl Acetate	X	X	X	A 16	F	-	F	A	A
Ethyl Alcohol	F	F	F	A 16	F	-	F	A	A
Ethyl Cellulose	F	F	F	A 16	F	-	X	F	F
Ethyl Chloride	X	X	X	X	A	-	F	F	F
Ethylene Dichloride	X	X	X	A 16	X	-	X	A	X
Ethylene Glycol	F	A	A	A	A	A	A	F	A
Exxon 3110 FR	A	A	A	A 16	X	A	A	A	A
Exxon Esstic	A	A	A	A 15	A	A	A	A	A
Exxon Nuto H 46, 68	A	A	A	A 15	X	A	A	A	A
Exxon Tellura Industrial Process Oils	A	A	A	A 15	X	A	A	A	A
Exxon Terresstic, EP	A	A	A	A 15	A	A	A	A	A
Exxon Turbo Oil 2380	X	F	F	A 16	X	X	A	A	A
Exxon Univolt 60, N61	F	A	A	A 15	X	A	A	A	A
FE 232 (Halon)	X	X	X	X	F	-	A	A	A
Fenso 150	-	A	A	-	X	A	A	A	A
Formaldehyde	X	X	X	A 16	A	-	X	F	A
Formic Acid	X	X	X	X	A	X	X	6	X
Freons see refrigerants	-	-	-	-	-	-	-	-	-
Fuel Oil	F	A	A	A 15	X	A	A	A	A
Fyre-Safe 120C, 126, 155, 1090E, 1150, 1220, 1300E	X	X	X	X	A, 7	F	A	A	A
Fyre-Safe 200C, 225, 211	F	A	A	A	A	F	A	A	A
Fyre-Safe W/O	A	A	A	A 16	X	A	A	A	A
Fyrguard 150, 150-M, 200	A	A	A	A	A	F	A	A	A
Fyrquel 60, 90, 150, 220, 300, 550, 1000	X	X	X	X	A, 7	F	A	A	A
Fyrquel EHC, GT, LT, VPF	X	X	X	X	A, 7	F	A	A	A
Fyrtek MF, 215, 290, 295	X	X	X	X	X	F	A	A	A
Gardner-Denver GD5000, GD8000	X	X	X	A 16	X	X	A	A	A
Gasoline	-	See 9	-	-	-	-	A	A	A
Glue	F	F	F	-	X	-	A	F	A
Glycerine, Glycerol	A	A	A	A 16	A	-	A	F	A
Grease	A	A	A	A 15	X	A	A	A	A
Gulf-FR Fluid P37, P40, P43, P45, P47	X	X	X	A 16	A	-	A	A	A
H-515 (NATO)	A	A	A	-	X	-	A	A	A
Halon 1211, 1301	F	F	F	F 16	-	-	A	A	A
Helium Gas	X	X	X	X	X	-	A	A	A
Heptane	X	F	F	A 16	X	-	A	A	A
Hexane	X	F	F	A 16	X	-	A	A	A
HF-20, HF-28	-	A	A	A	A	F	A	A	A
Houghto-Safe 1055, 1110, 1115, 1120, 1130 (9)	X	X	X	X	A, 7	F	A	A	A
Houghto-Safe 271 to 640	F	A	A	A	A	F	A	A	A
Houghto-Safe 419 Hydraulic Fluid	A	A	A	-	X	-	A	A	A
Houghto-Safe 419R Deicer Fluid	A	A	A	-	-	A	A	A	A
Houghto-Safe 5046, 5046W, 5047-F	A	A	A	A 16	X	-	A	A	A
HP 100C (Jack hammer oil)	F	A	A	A 15	X	A	A	A	A
HPWG 46B	F	A	A	A	-	F	A	A	A
Hul-E-Mul	A	A	A	-	X	-	A	A	A
Hychem C, EP1000, RDF	A	A	A	A 16	A	-	A	A	A
Hydra Safe E-190	A	A	A	A 16	X	-	A	A	A
Hydra-Cut 481, 496	A	A	A	-	X	-	A	A	A
Hydrafluid 760	A	A	A	-	X	-	A	A	A
Hydrochloric Acid	X	X	X	X	X	X	X	X	X
Hydrofluoric Acid	X	X	X	X	X	X	X	6	X
Hydrogen Gas	X	X	X	X	X	-	A	A	A

Medium	I	II	III	IV	V	VI	STEEL	BRASS	SS
Hydrogen Peroxide	X	X	X	A 16	X	-	X	X	6
Hydrogen Sulfide	X	X	X	X	A	-	X	X	6
Hydrolube	A	A	A	A 16	A	-	A	A	A
Hydrolubric 120-B, 141, 595	F	A	A	A 16	A	-	A	A	A
Hydrosafe Glycol 200	A	A	A	A	A	F	A	F	A
HyJet IV	X	X	X	X	A, 7	-	A	A	A
Ideal Yellow 77	A	A	A	A 16	X	-	A	A	A
Imol S150 to S550	X	X	X	-	-	-	A	A	A
Ingersoll Rand SSR Coolant	X	X	X	A 16	X	X	A	A	A
Isocyanates	F	F	F	A 16	X	-	A	-	A
Isooctane	X	F	F	A 16	X	-	A	A	A
Isopar H	X	X	X	X	X	-	A	A	A
Isopropyl Alcohol	F	F	F	A 16	F	-	F	A	A
Jayflex DIDP	X	X	X	X	A	-	A	A	A
JP3 and JP4	X	A,3	A,3	-	X	A(2)	A	A	A
JP5	X	A,3	A,3	F 16,3	X	A(2)	A	A	A
JP9	X	X	X	X	X	-	A	-	A
Kaeser 150P, 175P, 325R, 687R	X	X	X	A 16	X	-	A	A	A
Kerosene	X	A	A	F 15	X	A	A	A	A
KSL-214, 219, 220, 222	X	X	X	A 16	X	-	A	A	A
Lacquer	X	X	X	A 16	X	-	X	A	A
Lacquer Solvents	X	X	X	A 16	X	-	X	A	A
Lactic Acids	X	X	X	X	X	X	X	X	A
Lindol HF	X	X	X	A 16	A	-	A	A	A
Linseed Oil	A	A	A	A 16	A	-	A	A	A
LP-Gas		See 13				-	A	A	A
Magnesium Chloride	A	A	A	A 16	A	-	X	X	X
Magnesium Hydroxide	F	F	F	A 16	A	-	F	F	F
Magnesium Sulfate	A	A	A	A 16	A	-	A	F	A
Mercaptans	X	X	X	X	X	-	-	-	-
Methane		See 14				-	A	A	A
Methanol	F	F	F	A 16	F	-	F	A	A
Methyl Alcohol	F	F	F	A 16	F	-	F	A	A
Methyl Chloride	X	X	X	A 16	X	-	A	A	A
Methyl Ethyl Ketone (MEK)	X	X	X	A 16	X	-	F	A	A
Methyl Isopropyl-Ketone	X	X	X	X	X	-	F	A	A
Metsafe FR303, FR310, FR315, FR330, FR350	X	X	X	X	X	F	A	A	A
Microzol-T46	X	A	A	-	X	-	A	A	A
MIL-B-46176A	X	X	X	X	X	-	X	X	X
MIL-H-46170	X	F	F	A 16	X	-	A	A	A
MIL-H-5606	F	A	A	A 15	X	A	A	A	A
MIL-H-6083	F	A	A	A 16	X	-	A	A	A
MIL-H-7083	F	A	A	A 16	X	-	A	A	A
MIL-H-83282	F	A	A	A 16	X	-	A	A	A
MIL-L-2104, 2104B	F	A	A	A 15	X	A	A	A	A
MIL-L-23699	X	X	X	X	X	X	A	A	A
MIL-L-7808	F	A	A	-	X	-	A	A	A
Mine Guard FR	A	A	A	-	A	-	A	A	A
Mineral Oil	A	A	A	F 15	X	A	A	A	A
Mineral Spirits	8	8	8	8	X	-	A	A	A
Mobil Aero HFE	F	A	A	F 15	X	A	A	A	A
Mobil DTE 11M, 13M, 15M, 16M, 18M, 19M	F	A	A	A 15	X	A	A	A	A
Mobil DTE 22, 24, 25, 26	F	A	A	A 15	X	A	A	A	A
Mobil EAL 224H	X	A	A	X	-	-	A	A	A
Mobil EAL Artic 10, 15, 22,32, 46, 68, 100	X	X	X	X	X	X	A	A	A
Mobil Glygoyle 11, 22, 30, 80	A	A	A	-	X	-	A	A	A
Mobil HFA	F	A	A	A 16	X	-	A	A	A
Mobil Jet 2	X	F	F	A 16	X	-	A	A	A
Mobil Nyvac 20, 30, 200, FR	F	A	A	A	A	F	A	A	A
Mobil Rarus 824, 826, 827	X	X	X	A 16	X	X	A	A	A
Mobil SHC 600 Series	F	A	A	A 16	X	-	A	A	A
Mobil SHC 800 Series	F	A	A	A 16	X	-	A	A	A
Mobil SHL 624	-	A	A	A 16	X	-	A	A	A
Mobil Vactra Oil	A	A	A	F 15	X	A	A	A	A
Mobil XRL 1618B	X	X	X	X	A, 7	F	A	A	A
Mobilfluid 423	F	A	A	A 15	X	A	A	A	A
Mobilgear SHC 150, 220, 320, 460, 680	F	F	F	A 16	X	-	A	A	A
Mobilrama 525	A	A	A	F 15	X	A	A	A	A
Molub-Alloy 890	X	X	X	A 16	X	-	A	A	A
Moly Lube „HF“ 902	F	F	F	F 15	X	A	A	A	A
Monolec 6120 Hydraulic Oil	A	A	A	A 15	X	A	A	A	A
Morpholine (pure additive)	X	X	X	X	X	-	X	X	A
Naptha	X	F	F	A 16	X	-	A	A	A
Napthalene	X	X	X	A 16	X	-	A	A	A
Natural Gas		See 14				-	A	A	A
Nitric Acid	X	X	X	X	X	X	X	X	F

Medium	I	II	III	IV	V	VI	STEEL	BRASS	SS
Nitrobenzene	X	X	X	A 16	X	-	X	X	A
Nitrogen, gas	F, 1	F, 1	F, 1	F 16, 1	F, 1	-	A	A	A
NORPAR 12, 13, 15	8	8	8	8	X	-	A	A	A
Nuto H 46, 68	A	A	A	A 15	X	A	A	A	A
Nyvac 20, 30, 200, FR	F	A	A	A	A	F	A	A	A
Nyvac Light	X	X	X	-	A	-	A	A	A
Oceanic HW	F	A	A	A	X	F	A	A	A
Oxygen, gas	X	X	X	X	X	-	X	A	A
Ozone	F	F	F	-	A	-	A	A	A
Pacer SLC 150, 300, 500, 700	X	X	X	A 16	X	-	A	A	A
Pennzbell AWX	F	A	A	F 15	X	A	A	A	A
Perchloroethylene	X	X	X	X	X	-	F	X	A
Petroleum Ether	X	F	F	F 15	X	A	A	A	A
Petroleum Oils	A	A	A	A 15	X	A	A	A	A
Phenol (Carbolic Acid)	X	X	X	A 16	X	X	X	F	A
Phosphate Ester Blends	X	X	X	X	X	F	A	A	A
Phosphate Esters	X	X	X	X	A, 7	-	A	A	A
Phosphoric Acid	X	X	X	X	X	X	X	X	F
Plurasafe P 1000, 1200	F	A	A	A	F	F	A	A	A
Polyalkylene Glycol	A	F	F	-	X	-	A	A	A
Polyol Ester	X	F	A	X	X	-	A	A	A
Potassium Chloride	A	A	A	A 16	A	-	X	F	F
Potassium Hydroxide	X	X	X	A 16	A	-	6	X	A
Potassium Sulfate	A	A	A	A 16	A	-	A	A	A
Propane		See 13				-	A	A	A
Propylene Glycol	F	A	A	A 16	A	-	F	F	F
Pydraul 10-E, 29-E, 50-E, 65-E, 90-E, 115-E	X	X	X	X	A, 7	F	A	A	A
Pydraul 230-C, 312-C, 68-S	X	X	X	X	A, 7	F	A	A	A
Pydraul 60, 150, 625, F9	X	X	X	X	A, 7	-	A	A	A
Pydraul 90, 135, 230, 312, 540, MC	X	X	X	X	X	-	A	A	A
Pydraul A-200	X	X	X	A 16	X	-	A	A	A
Pyro Gard 43, 230, 630	X	X	X	X	X	-	A	A	A
Pyro Gard C, D, R, 40S, 40W	F	A	A	F 16	X	A	A	A	A
Pyro Guard 53, 55, 51, 42	X	X	X	X	A, 7	-	A	A	A
Quintolubric 700	A	A	A	A 16	A	-	A	F	A
Quintolubric 807-SN	F	A	A	-	X	-	A	A	A
Quintolubric 822, 833	X	F, 5	A, 5	X	X	X	A	A	A
Quintolubric 822-68EHC (71°C, 160°F maximum)	X	F, 5	A, 5	-	-	-	A	A	A
Quintolubric 888	X	F, 5	A, 5	X	X	-	A	A	A
Quintolubric 957, 958	F	A	A	A	A	F	A	A	A
Quintolubric N822-300	~	~	A	-	-	-	A	A	A
Rando	A	A	A	A 15	X	A	A	A	A
Rayco 782	X	F	A	X	X	-	X	X	X
Refrigerant 124		See 4				X	A	A	A
Refrigerant Freon 113, 114	X	X	X	X	X	X	A	A	A
Refrigerant Freon 12		See 4		X		X	A	A	A
Refrigerant Freon 22		See 4		X		X	A	A	A
Refrigerant Freon 502		See 4		X		X	A	A	A
Refrigerant HFC134A		See 4		X		X	A	A	A
Reolube Turbofluid 46	X	X	X	X	A, 7	-	A	A	A
Rotella	A	A	A	A 15	X	A	A	A	A
Royal Bio Guard 3032, 3046, 3068, 3100	X	~	A	X	X	X	A	A	A
Royco 2200, 2210, 2222, 2232, 2246, 2268	X	X	X	X	X	X	A	A	A
Royco 4032, 4068, 4100, 4150	X	X	X	A 16	X	X	A	A	A
Royco 756, 783	A	A	A	A 15	X	A	A	A	A
Royco 770	X	F	F	F 16	X	-	A	A	A
RTV Silicone Adhesive Sealants	X	X	X	X	X	-	A	A	A
Safco-Safe T10, T20	-	-	-	-	A	-	F	F	A
Safety-Kleen ISO 32, 46, 68 hydraulic oil	F	A	A	-	X	A	A	A	A
Safety-Kleen Solvent	8	8	8	8	X	-	A	A	A
Santoflex 13	F	F	F	-	F	-	A	A	A
Santosafe 300	X	X	X	-	X	-	A	A	A
Santosafe W/G 15 to 30	-	-	-	A 16	A	-	A	A	A
Sea Water	F	F	F	A 16	A	-	X	F	A
Sewage	F	F	F	A 16	F	-	X	F	A
Shell 140 Solvent	8	8	8	8	X	-	A	A	A
Shell Clavus HFC 68	X	X	X	X	X	X	A	A	A
Shell Comptella Oil	F	F	F	A 15	X	A	A	A	A
Shell Comptella Oil S 46, 68	F	F	F	A 15	X	A	A	A	A
Shell Comptella Oil SM	F	F	F	A 15	X	A	A	A	A
Shell Diala A, (R) Oil AX	F	A	A	F 15	X	A	A	A	A
Shell FRM	-	-	-	-	X	-	A	A	A
Shell IRUS 902, 905	A	A	A	-	A	-	A	A	A
Shell Pella-A	A	A	A	A 16	X	-	A	A	A
Shell Tellus	F	A	A	A 15	X	A	A	A	A
Shell Thermia Oil C	A	A	A	A 15	X	A	A	A	A

Medium	I	II	III	IV	V	VI	STEEL	BRASS	SS
Shell Turbo R	X	F	F	A 16	X	X	A	A	A
SHF 220, 300, 450	X	X	A	X	X	X	A	A	A
Silicate Esters	A	F	F	A 16	X	-	A	A	A
Silicone Oils	A	A	A	-	-	-	A	A	A
Silicone Sealants	X	X	X	X	X	-	A	A	A
Skydrol 500B-4, LD-4	X	X	X	X	A, 7	F	A	A	A
Soap Solutions	X	F	F	F 16	A	-	A	A	A
Soda Ash, Sodium Carbonate	A	A	A	A 16	A	-	A	F	A
Sodium Bisulfate	F	F	F	A 16	A	-	F	A	F
Sodium Chloride	F	F	F	A 16	A	-	X	F	A
Sodium Hydroxide	X	X	X	A 16	A	-	A	X	A
Sodium Hypochlorite	F	F	F	X	F	-	X	X	X
Sodium Nitrate	F	F	F	A 16	A	-	A	F	A
Sodium Peroxide	X	X	X	X	A	-	X	X	A
Sodium Silicate	A	A	A	A 16	A	-	A	A	A
Sodium Sulfate	A	A	A	A 16	A	-	A	A	A
Soybean Oil	F	A	A	A 16	A	-	A	A	A
SSR Coolant	X	X	X	A 16	X	X	A	A	A
Steam	X	X	X	X	X	-	F	A	A
Stoddard Solvent	8	8	8	8	X	-	A	A	A
Sulfur Chloride	X	X	X	A 16	X	-	X	X	X
Sulfur Dioxide	X	X	X	X	F	-	X	F	F
Sulfur Trioxide	X	X	X	A 16	F	-	X	X	X
Sulfuric Acid (0% to 30% room temperature)	F, 6	F, 6	F, 6	X	F, 6	-	6	X	6
Summa-20, Rotor, Recip	X	X	X	A 16	X	-	A	A	A
Summit DSL-32,68,100,125	X	X	X	A 16	X	-	A	A	A
Sun Minesafe, Sun Safe	X	F	F	A 16	X	-	A	A	A
Sundex 8125	X	F	F	-	A	-	A	A	A
Suniso 3GS	A	A	A	A 15	X	A	A	A	A
Sun-Vis 722	X	F	F	-	X	-	A	A	A
Super Hydraulic Oil 100, 150, 220	A	A	A	A 15	X	A	A	A	A
SUVA MP 39, 52, 66	X	X	X	X	X	X	A	A	A
SYNCON Oil	X	X	X	X	X	-	A	A	A
Syndale 2820	X	F	F	-	-	-	A	A	A
Synesstic 32,68,100	X	X	X	X	X	X	A	A	A
Syn-Flo 70,90	X	X	X	A 16	X	-	A	A	A
SYN-O-AD 8478	X	X	X	X	A, 7	F	A	A	A
Tannic Acid	F	A	A	A 16	A	X	X	F	X
Tar	F	F	F	A 16	X	-	X	F	A
Tellus (Shell)	F	A	A	A 15	X	A	A	A	A
Texaco 760 Hydrafluid	-	-	-	-	X	-	A	A	A
Texaco 766, 763 (200 - 300)	-	-	-	-	A	-	F	F	A
Texaco A-Z Oil	A	A	A	F 15	X	A	A	A	A
Texaco Spindura Oil 22	F	F	F	F 15	X	A	A	A	A
Texaco Way Lubricant 68	A	A	A	A 15	X	A	A	A	A
Thanol-R-650-X	X	F	F	-	X	-	A	A	A
Thermanol 60	X	X	X	X	X	-	A	A	A
Toluene, Toluol	X	X	X	X	X	-	A	A	A
Transmission Oil	A	A	A	A 15	X	A	A	A	A
Tribol 1440	X	F	F	X	X	F	A	A	A
Trichloroethylene	X	X	X	A 16	X	-	X	A	A
Trim-Sol	F	A	A	A 16	X	-	A	A	A
Turbinol 50, 1122, 1223	X	X	X	X	A, 7	-	A	A	A
Turpentine	X	X	X	A 16	X	-	A	A	A
Ucon Hydrolubes	F	A	A	A	A	F	A	A	A
UltraChem 215,230,501,751	X	X	X	A 16	X	-	A	A	A
Univis J26	A	A	A	A 15	X	A	A	A	A
Unleaded Gasoline		See 9				-	A	A	A
Unocal 66/3 Mineral Spirits	8	8	8	8	X	-	A	A	A
Urea	F	F	F	A 16	F	-	F	-	F
Urethane Formulations	A	A	A	A 16	-	-	A	A	A
Van Straaten 902	A	A	A	A 16	X	-	A	A	A
Varnish	X	X	X	A 16	X	-	F	F	A
Varsol	8	F	F	8	X	-	A	A	A
Versilube F44, F55		A	A	A 16	-	-	A	A	A
Vinegar	X	X	X	A 16	A	-	F	X	A
Vital 29, 4300, 5230, 5310	X	X	X	X	X	-	A	A	A
Volt Esso 35	A	A	A	A 16	X	-	A	A	A
Water	F	A	A	A	A	A	F	A	A
Water / Glycols	A	A	A	A	A	F	A	F	A
Xylene, Xylol	X	X	X	X	X	-	A	A	A
Zerol 150	A	A	A	A 15	X	A	A	A	A
Zinc Chloride	A	A	A	X	A	-	X	X	F
Zinc Sulfate	A	A	A	X	A	-	X	A	A

Parker Safety Guide for Selecting and Using Hose, Tubing, Fittings and Related Accessories

Parker Publication No. 4400-B.1-EUR

Revised: March, 2005



WARNING

Failure or improper selection or improper use of hose, tubing, fittings, assemblies or related accessories ("Products") can cause death, personal injury and property damage. Possible consequences of failure or improper selection or improper use of these Products include but are not limited to:

- Fittings thrown off at high speed.
- High velocity fluid discharge.
- Explosion or burning of the conveyed fluid.
- Electrocutation from high voltage electric powerlines.
- Contact with suddenly moving or falling objects that are controlled by the conveyed fluid.
- Injections by high-pressure fluid discharge.
- Dangerously whipping Hose.
- Contact with conveyed fluids that may be hot, cold, toxic or otherwise injurious.
- Sparking or explosion caused by static electricity buildup or other sources of electricity.
- Sparking or explosion while spraying paint or flammable liquids.
- Injuries resulting from inhalation, ingestion or exposure to fluids.

Before selecting or using any of these Products, it is important that you read and follow the instructions below. Only Hose from Parker's Stratoflex Products Division is approved for in flight aerospace applications, and no other Hose can be used for such in flight applications.

1.0 GENERAL INSTRUCTIONS

1.1 Scope

This safety guide provides instructions for selecting and using (including assembling, installing, and maintaining) these Products. For convenience, all rubber and/or thermoplastic products commonly called "hose" or "tubing" are called "Hose" in this safety guide. All assemblies made with Hose are called "Hose Assemblies". All products commonly called "fittings" or "couplings" are called "Fittings". All related accessories (including crimping and swaging machines and tooling) are called "Related Accessories". This safety guide is a supplement to and is to be used with, the specific Parker publications for the specific Hose, Fittings and Related Accessories that are being considered for use.

1.2 Fail-Safe

Hose, and Hose Assemblies and Fittings can and do fail without warning for many reasons. Design all systems and equipment in a failsafe mode, so that failure of the Hose or Hose Assembly or Fitting will not endanger persons or property.

1.3 Distribution

Provide a copy of this safety guide to each person that is responsible for selecting or using Hose and Fitting products. Do not select or use Parker Hose or Fittings without thoroughly reading and understanding this safety guide as well as the specific Parker publications for the products considered or selected.

1.4 User Responsibility

Due to the wide variety of operating conditions and applications for Hose and Fittings, Parker and its distributors do not represent or warrant that any particular Hose or Fitting is suitable for any specific end use system. This safety guide does not analyze all technical parameters that must be considered in selecting a product. The user, through its own analysis and testing, is solely responsible for:

- Making the final selection of the Hose and Fitting.
- Assuring that the user's requirements are met and that the application presents no health or safety hazards.
- Providing all appropriate health and safety warnings on the equipment on which the Hose and Fittings are used.
- Assuring compliance with all applicable government and industry standards.

1.5 Additional Questions

Call the appropriate Parker technical service department if you have any questions or require any additional information. See the Parker publication for the product being considered or used, or call 00-800-2727-5374, or go to www.parker.com, for telephone numbers of the appropriate technical service department.

2.0 HOSE AND FITTING SELECTION INSTRUCTIONS

2.1 Electrical Conductivity

Certain applications require that the Hose be nonconductive to prevent electrical current flow. Other applications require the Hose and the Fitting and the Hose/Fitting interface to be sufficiently conductive to drain off static electricity. Extreme care must be exercised when selecting Hose and Fittings for these or any other applications in which electrical conductivity or nonconductivity is a factor. The electrical conductivity or nonconductivity of Hose and Fittings is dependent upon many factors and may be susceptible to change. These factors include but are not limited to the various materials used to make the Hose and the Fittings, Fitting finish (some Fitting finishes are electrically conductive while others are nonconductive), manufacturing methods (including moisture control), how the Fittings contact the Hose, age and amount of deterioration or damage or other changes, moisture content of the Hose at any particular time, and other factors. The following are considerations for electrically nonconductive and conductive Hose. For other applications consult the individual catalog pages and the appropriate industry or regulatory standards for proper selection.

2.1.1 Electrically Nonconductive Hose

Certain applications require that the Hose be nonconductive to prevent electrical current flow or to maintain electrical isolation. For these applications that require Hose to be electrically nonconductive, including but not limited to applications near high voltage electric lines, only special nonconductive Hose can be used. The manufacturer of the equipment in which the nonconductive Hose is to be used must be consulted to be certain that the Hose and Fittings that are selected are proper for the application. Do not use any Parker Hose or Fitting for any such application requiring nonconductive Hose, including but not limited to applications near high voltage electric lines, unless (i) the application is expressly approved in the Parker technical publication for the product, (ii) the Hose is marked "nonconductive", and (iii) the manufacturer of the equipment on which the Hose is to be used specifically approves the particular Parker Hose and Fitting for such use.

2.1.2 Electrically Conductive Hose

Parker manufactures special Hose for certain applications that require electrically conductive Hose. Parker manufactures special Hose for conveying paint in airless paint spraying applications. This Hose is labeled "Electrically Conductive Airless Paint Spray Hose" on its layline and packaging. This Hose must be properly connected to the appropriate Parker Fittings and properly grounded in order to dissipate dangerous static charge buildup, which occurs in all airless paint spraying applications. Do not use any other Hose for airless paint spraying, even if electrically conductive. Use of any other Hose or failure to properly connect the Hose can cause a fire or an explosion resulting in death, personal injury, and property damage. Parker manufactures a special Hose for certain compressed natural gas ("CNG") applications where static electricity buildup may occur. Parker CNG Hose assemblies comply with AGA Requirements 1-93, "Hoses for Natural Gas Vehicles and Fuel Dispensers". This Hose is labeled "Electrically Conductive for CNG Use" on its layline and packaging. This Hose must be properly connected to the appropriate Parker Fittings and properly grounded in order to dissipate dangerous static charge buildup, which occurs in, for example, high velocity CNG dispensing or transfer. Do not use any other Hose for CNG applications where static charge buildup may occur, even if electrically conductive. Use of other Hoses in CNG applications or failure to properly connect or ground this Hose can cause a fire or an explosion resulting in death, personal injury, and property damage. Care must also be taken to protect against CNG permeation through the Hose wall. See section 2.6, Permeation, for more information. Parker CNG Hose is intended for dispenser and vehicle use at a maximum temperature of 82°C / 180°F. Parker CNG Hose should not be used in confined spaces or unventilated areas or areas exceeding 82°C / 180°F. Final assemblies must be tested for leaks. CNG Hose Assemblies should be tested on a monthly basis for conductivity per AGA 1-93. Parker manufactures special Hose for aerospace in flight applications. Aerospace in flight applications employing Hose to transmit fuel, lubricating fluids and hydraulic fluids require a special Hose with a conductive inner tube. This Hose for in flight applications is available only from Parker's Stratoflex Products Division. Do not use any other Parker Hose for in flight applications, even if electrically conductive. Use of other Hoses for in flight applications or failure to properly connect or ground this Hose can cause a fire or an explosion resulting in death, personal injury, and property damage. These Hose assemblies for in flight applications must meet all applicable aerospace industry, aircraft engine, and aircraft requirements.

2.2 Pressure

Hose selection must be made so that the published maximum recommended working pressure of the Hose is equal to or greater than the maximum system pressure. Surge pressures or peak transient pressures in the system must be below the published maximum working pressure for the Hose. Surge pressures and peak pressures can usually only be determined by sensitive electrical instrumentation that measures and indicates pressures at millisecond intervals. Mechanical pressure gauges indicate only average pressures and cannot be used to determine surge pressures or peak transient pressures. Published burst pressure ratings for Hose is for manufacturing test purposes only and is no indication that the Product can be used in applications at the burst pressure or otherwise above the published maximum recommended working pressure.

2.3 Suction

Hoses used for suction applications must be selected to ensure that the Hose will withstand the vacuum and pressure of the system. Improperly selected Hose may collapse in suction application.

2.4 Temperature

Be certain that fluid and ambient temperatures, both steady and transient, do not exceed the limitations of the Hose. Temperatures below and above the recommended limit can degrade Hose to a point where a failure may occur and release fluid. Properly insulate and protect the Hose Assembly when routing near hot objects (e.g. manifolds). Do not use any Hose in any application where failure of the Hose could result in the conveyed

fluids (or vapors or mist from the conveyed fluids) contacting any open flame, molten metal, or other potential fire ignition source that could cause burning or explosion of the conveyed fluids or vapors.

2.5 Fluid Compatibility

Hose Assembly selection must assure compatibility of the Hose tube, cover, reinforcement, and Fittings with the fluid media used. See the fluid compatibility chart in the Parker publication for the product being considered or used. This information is offered only as a guide. Actual service life can only be determined by the end user by testing under all extreme conditions and other analysis. Hose that is chemically compatible with a particular fluid must be assembled using Fittings and adapters containing likewise compatible seals.

2.6 Permeation

Permeation (that is, seepage through the Hose) will occur from inside the Hose to outside when Hose is used with gases, liquid and gas fuels, and refrigerants (including but not limited to such materials as helium, diesel fuel, gasoline, natural gas, or LPG). This permeation may result in high concentrations of vapors which are potentially flammable, explosive, or toxic, and in loss of fluid. Dangerous explosions, fires, and other hazards can result when using the wrong Hose for such applications. The system designer must take into account the fact that this permeation will take place and must not use Hose if this permeation could be hazardous. The system designer must take into account all legal, government, insurance, or any other special regulations which govern the use of fuels and refrigerants. Never use a Hose even though the fluid compatibility is acceptable without considering the potential hazardous effects that can result from permeation through the Hose Assembly. Permeation of moisture from outside the Hose to inside the Hose will also occur in Hose assemblies, regardless of internal pressure. If this moisture permeation would have detrimental effects (particularly, but not limited to refrigeration and air conditioning systems), incorporation of sufficient drying capacity in the system or other appropriate system safeguards should be selected and used.

2.7 Size

Transmission of power by means of pressurized fluid varies with pressure and rate of flow. The size of the components must be adequate to keep pressure losses to a minimum and avoid damage due to heat generation or excessive fluid velocity.

2.8 Routing

Attention must be given to optimum routing to minimize inherent problems (kinking or flow restriction due to Hose collapse, twisting of the Hose, proximity to hot objects or heat sources).

2.9 Environment

Care must be taken to insure that the Hose and Fittings are either compatible with or protected from the environment (that is, surrounding conditions) to which they are exposed. Environmental conditions including but not limited to ultraviolet radiation, sunlight, heat, ozone, moisture, water, salt water, chemicals, and air pollutants can cause degradation and premature failure.

2.10 Mechanical Loads

External forces can significantly reduce Hose life or cause failure. Mechanical loads which must be considered include excessive flexing, twist, kinking, tensile or side loads, bend radius, and vibration. Use of swivel type Fittings or adapters may be required to insure no twist is put into the Hose. Unusual applications may require special testing prior to Hose selection.

2.11 Physical Damage

Care must be taken to protect Hose from wear, snagging, kinking, bending smaller than minimum bend radius, and cutting, any of which can cause premature Hose failure. Any Hose that has been kinked or bent to a radius smaller than the minimum bend radius, and any Hose that has been cut or is cracked or is otherwise damaged, should be removed and discarded.

2.12 Proper End Fitting

See instructions 3.2 through 3.5. These recommendations may be substantiated by testing to industry standards such as EN853, EN854, EN857, ISO17165-2, SAE J517 for hydraulic applications, or MIL-A-5070, AS1339, or AS3517 for Hoses from Parker's Stratoflex Products Division for aerospace applications.

2.13 Length

When establishing a proper Hose length, motion absorption, Hose length changes due to pressure, and Hose and machine tolerances and movement must be considered.

2.14 Specifications and Standards

When selecting Hose and Fittings, government, industry, and Parker specifications and recommendations must be reviewed and followed as applicable.

2.15 Hose Cleanliness

Hose components may vary in cleanliness levels. Care must be taken to insure that the Hose Assembly selected has an adequate level of cleanliness for the application.

2.16 Fire Resistant Fluids

Some fire resistant fluids that are to be conveyed by Hose require use of the same type of Hose as used with petroleum base fluids. Some such fluids require a special Hose, while a few fluids will not work with any Hose at all. See instructions 2.5 and 1.5. The wrong Hose may fail after a very short service. In addition, all liquids but pure water may burn fiercely under certain conditions, and even pure water leakage may be hazardous.

2.17 Radiant Heat

Hose can be heated to destruction without contact by such nearby items as hot manifolds or molten metal. The same heat source may then initiate a fire. This can occur despite the presence of cool air around the Hose.

2.18 Welding or Brazing

When using a torch or arc-welder in close proximity to hydraulic lines, the hydraulic lines should be removed or shielded with appropriate fire resistant materials. Flame or weld spatter could burn through the Hose and possibly ignite escaping fluid resulting in a catastrophic failure. Heating of plated parts, including Hose Fittings and adapters, above 450°F (232°C) such as during welding, brazing, or soldering may emit deadly gases.

2.19 Atomic Radiation

Atomic radiation affects all materials used in Hose assemblies. Since the long-term effects may be unknown, do not expose Hose assemblies to atomic radiation.

2.20 Aerospace Applications

The only Hose and Fittings that may be used for in flight aerospace applications are those available from Parker's Stratoflex Products Division. Do not use any other Hose or Fittings for in flight applications. Do not use any Hose or Fittings from Parker's Stratoflex Products Division with any other Hose or Fittings, unless expressly approved in writing by the engineering manager or chief engineer of Stratoflex Products Division and verified by the user's own testing and inspection to aerospace industry standards.

2.21 Unlocking Couplings

Ball locking couplings or other couplings with disconnect sleeves can unintentionally disconnect if they are dragged over obstructions or if the sleeve is bumped or moved enough to cause disconnect. Threaded couplings should be considered where there is a potential for accidental uncoupling.

3.0 HOSE AND FITTING ASSEMBLY AND INSTALLATION INSTRUCTIONS

3.1 Component Inspection

Prior to assembly, a careful examination of the Hose and Fittings must be performed. All components must be checked for correct style, size, catalog number, and length. The Hose must be examined for cleanliness, obstructions, blisters, cover looseness, kinks, cracks, cuts or any other visible defects. Inspect the Fitting and sealing surfaces for burrs, nicks, corrosion or other imperfections. Do NOT use any component that displays any signs of nonconformance.

3.2 Hose and Fitting Assembly

Do not assemble a Parker Fitting on a Parker Hose that is not specifically listed by Parker for that Fitting, unless authorized in writing by the engineering manager or chief engineer of the appropriate Parker division. Do not assemble a Parker Fitting on another manufacturer's Hose or a Parker Hose on another manufacturer's Fitting unless (i) the engineering manager or chief engineer of the appropriate Parker division approves the Assembly in writing or that combination is expressly approved in the appropriate Parker literature for the specific Parker product, and (ii) the user verifies the Assembly and the application through analysis and testing. For Parker Hose that does not specify a Parker Fitting, the user is solely responsible for the selection of the proper Fitting and Hose Assembly procedures. See instruction 1.4. The Parker published instructions must be followed for assembling the Fittings on the Hose. These instructions are provided in the Parker Fitting catalog for the specific Parker Fitting being used, or by calling 00-800-2727-5374, or at www.parker.com.

3.3 Related Accessories

Do not crimp or swage any Parker Hose or Fitting with anything but the listed swage or crimp machine and dies in accordance with Parker published instructions. Do not crimp or swage another manufacturer's Fitting with a Parker crimp or swage die unless authorized in writing by the engineering manager or chief engineer of the appropriate Parker division.

3.4 Parts

Do not use any Parker Fitting part (including but not limited to socket, shell, nipple, or insert) except with the correct Parker mating parts, in accordance with Parker published instructions, unless authorized in writing by the engineering manager or chief engineer of the appropriate Parker division.

3.5 Reusable/Permanent

Do not reuse any field attachable (reusable) Hose Fitting that has blown or pulled off a Hose. Do not reuse a Parker permanent Hose Fitting (crimped or swaged) or any part thereof. Complete Hose Assemblies may only be reused after proper inspection under section 4.0. Do not assemble Fittings to any previously used hydraulic Hose that was in service, for use in a fluid power application.

3.6 Pre-Installation Inspection

Prior to installation, a careful examination of the Hose Assembly must be performed. Inspect the Hose Assembly for any damage or defects. Do NOT use any Hose Assembly that displays any signs of nonconformance.

3.7 Minimum Bend Radius

Installation of a Hose at less than the minimum listed bend radius may significantly reduce the Hose life. Particular attention must be given to preclude sharp bending at the Hose to Fitting juncture. Any bending during installation at less than the minimum bend radius must be avoided. If any Hose is kinked during installation, the Hose must be discarded.

3.8 Twist Angle and Orientation

Hose Assembly installation must be such that relative motion of machine components does not produce twisting.

3.9 Securement

In many applications, it may be necessary to restrain, protect, or guide the Hose to protect it from damage by unnecessary flexing, pressure surges, and contact with other mechanical components. Care must be taken to insure such restraints do not introduce additional stress or wear points.

3.10 Proper Connection of Ports

Proper physical installation of the Hose Assembly requires a correctly installed port connection insuring that no twist or torque is transferred to the Hose when the Fittings are being tightened or otherwise during use.

3.11 External Damage

Proper installation is not complete without insuring that tensile loads, side loads, kinking, flattening, potential abrasion, thread damage, or damage to sealing surfaces are corrected or eliminated. See instruction 2.10.

3.12 System Checkout

All air entrapment must be eliminated and the system pressurized to the maximum system pressure (at or below the Hose maximum working pressure) and checked for proper function and freedom from leaks. Personnel must stay out of potential hazardous areas while testing and using.

3.13 Routing

The Hose Assembly should be routed in such a manner so if a failure does occur, the escaping media will not cause personal injury or property damage. In addition, if fluid media comes in contact with hot surfaces, open flame, or sparks, a fire or explosion may occur. See section 2.4.

4.0 HOSE AND FITTING MAINTENANCE AND REPLACEMENT INSTRUCTIONS

4.1

Even with proper selection and installation, Hose life may be significantly reduced without a continuing maintenance program. The severity of the application, risk potential from a possible Hose failure, and experience with any Hose failures in the application or in similar applications should determine the frequency of the inspection and the replacement for the Products so that Products are replaced before any failure occurs. A maintenance program must be established and followed by the user and, at minimum, must include instructions 4.2 through 4.7.

4.2 Visual Inspection Hose/Fitting

Any of the following conditions require immediate shut down and replacement of the Hose Assembly:

- Fitting slippage on Hose,
- Damaged, cracked, cut or abraded cover (any reinforcement exposed);
- Hard, stiff, heat cracked, or charred Hose;
- Cracked, damaged, or badly corroded Fittings;
- Leaks at Fitting or in Hose;
- Kinked, crushed, flattened or twisted Hose; and
- Blistered, soft, degraded, or loose cover.

4.3 Visual Inspection All Other

The following items must be tightened, repaired, corrected or replaced as required:

- Leaking port conditions;
- Excess dirt buildup;
- Worn clamps, guards or shields; and
- System fluid level, fluid type, and any air entrapment.

4.4 Functional Test

Operate the system at maximum operating pressure and check for possible malfunctions and leaks. Personnel must avoid potential hazardous areas while testing and using the system. See section 2.2.

4.5 Replacement Intervals

Hose assemblies and elastomeric seals used on Hose Fittings and adapters will eventually age, harden, wear and deteriorate under thermal cycling and compression set. Hose Assemblies and elastomeric seals should be inspected and replaced at specific replacement intervals, based on previous service life, government or industry recommendations, or when failures could result in unacceptable downtime, damage, or injury risk. See section 1.2.

4.6 Hose Inspection and Failure

Hydraulic power is accomplished by utilizing high-pressure fluids to transfer energy and do work. Hoses, Fittings, and Hose Assemblies all contribute to this by transmitting fluids at high pressures. Fluids under pressure can be dangerous and potentially lethal and, therefore, extreme caution must be exercised when working with fluids under pressure and handling the Hoses transporting the fluids. From time to time, Hose Assemblies will fail if they are not replaced at proper time intervals. Usually these failures are the result of some form of misapplication, abuse, wear, or failure to perform proper maintenance. When Hoses fail, generally the high-pressure fluids inside escape in a stream which may or may not be visible to the user. Under no circumstances should the user attempt to locate the leak by "feeling" with their hands or any other part of their body. High-pressure fluids can and will penetrate the skin and cause severe tissue damage and possibly loss of limb. Even seemingly minor hydraulic fluid injection injuries must be treated immediately by a physician with knowledge of the tissue damaging properties of hydraulic fluid. If a Hose failure occurs, immediately shut down the equipment and leave the area until pressure has been completely released from the Hose Assembly. Simply shutting down the hydraulic pump may or may not eliminate the pressure in the Hose Assembly. Many times check valves, etc., are employed in a system and can cause pressure to remain in a Hose Assembly even when pumps or equipment are not operating. Tiny holes in the Hose, commonly known as pinholes, can eject small, dangerously powerful but hard to see streams of hydraulic fluid. It may take several minutes or even hours for the pressure to be relieved so that the Hose Assembly may be examined safely. Once the pressure has been reduced to zero, the Hose Assembly may be taken off the equipment and examined. It must always be replaced if a failure has occurred. Never attempt to patch or repair a Hose Assembly that has failed. Consult the nearest Parker distributor or the appropriate Parker division for Hose Assembly replacement information. Never touch or examine a failed Hose Assembly unless it is obvious that the Hose no longer contains fluid under pressure. The high-pressure fluid is extremely dangerous and can cause serious and potentially fatal injury.

4.7 Elastomeric seals

Elastomeric seals will eventually age, harden, wear and deteriorate under thermal cycling and compression set. Elastomeric seals should be inspected and replaced.

4.8 Refrigerant gases

Special care should be taken when working with refrigeration systems. Sudden escape of refrigerant gases can cause blindness if the escaping gases contact the eye and can cause freezing or other severe injuries if it contacts any other portion of the body.

4.9 Compressed natural gas (CNG)

Parker CNG Hose Assemblies should be tested after installation and before use, and at least on a monthly basis per AGA 1-93 Section 4.2 "Visual Inspection Hose/Fitting". The recommended procedure is to pressurize the Hose and check for leaks and to visually inspect the Hose for damage.

Caution: Matches, candles, open flame or other sources of ignition shall not be used for Hose inspection. Leak check solutions should be rinsed off after use.

Identifying Fitting Types

In general fittings can be identified by their visual appearance, their sealing surface/ sealing type or by their thread type/form. Viewing the following pages the visual identification will be self explanatory. The sealing mechanism and the method of thread identification however, needs further explanation

Determining Sealing Mechanisms:

- Thread interface
- O-ring
- Matching angle or metal to metal joint
- Mated angle with O-ring

Thread Interface

The sealing is assured by the flattening of the edges of the threads when the male is screwed into the female fitting. Typically the front of the male fittings are narrower than the back of the fittings – often referred to as tapered threads.

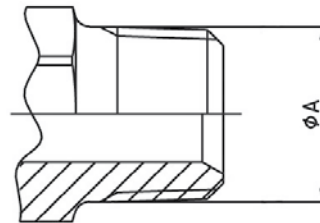

O-ring

The O-ring on the male is compressed against the corresponding female and assures the seal. This type of sealing mechanism should be the preferred choice for high-pressure applications.

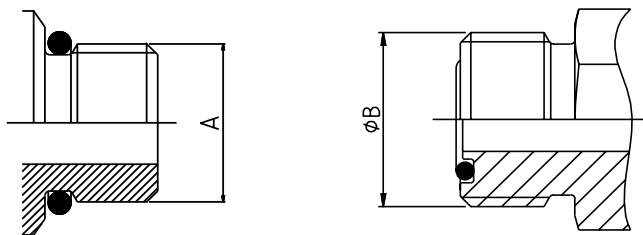

Matching Angle or Metal to Metal Joint

The seal takes place where the two angled faces of the male and corresponding female meet and are wedged into one another by the tightening of the threaded nut.

The sealing surfaces can either be convex or concave (seat) on the male or in the head of the pipe of the female as shown.

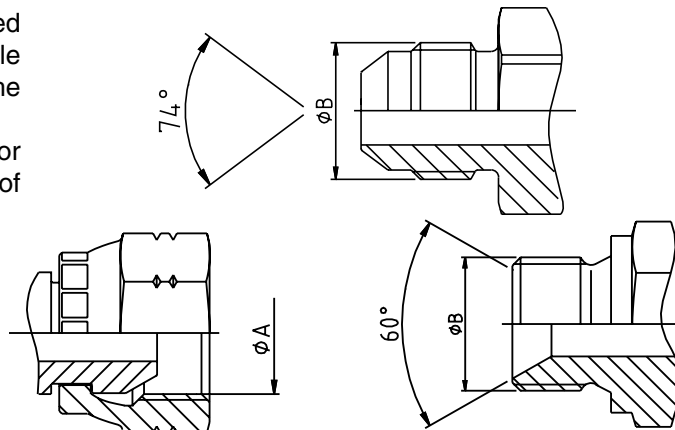

Matching Angle with O-ring

These fittings combine the functionality of both the matching angle seal with the O-ring. The O-ring is in the angled sealing surface of the fitting so that when the threaded male and female are screwed together the sealing surfaces wedge together and at the same time deform the O-ring between them.

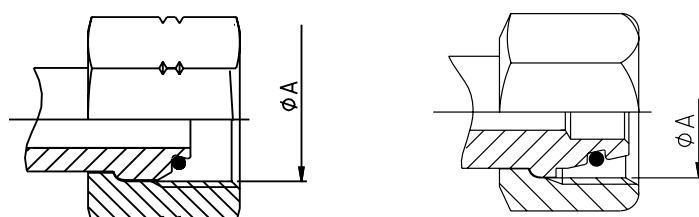

Determining Thread Type

In general the appearance of the threads of various fittings looks similar and hinders the easy identification of the thread. To assure the correct identification, the threads must be measured and compared to the tables listed in the following section.

Thread Gauge

Using a thread gauge, the number of threads per inch can be determined. Holding the gauge and coupling threads in front of a lighted background helps to obtain an accurate measurement.

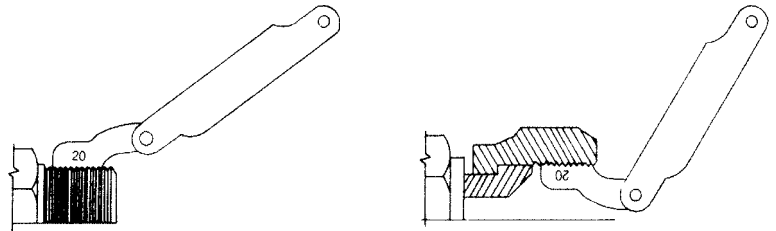

Caliper Measure

A vernier caliper should be used to measure the thread diameter of the largest point. (Outside diameter (O.D.) of male threads – Inside Diameter (I.D.) of female threads.)

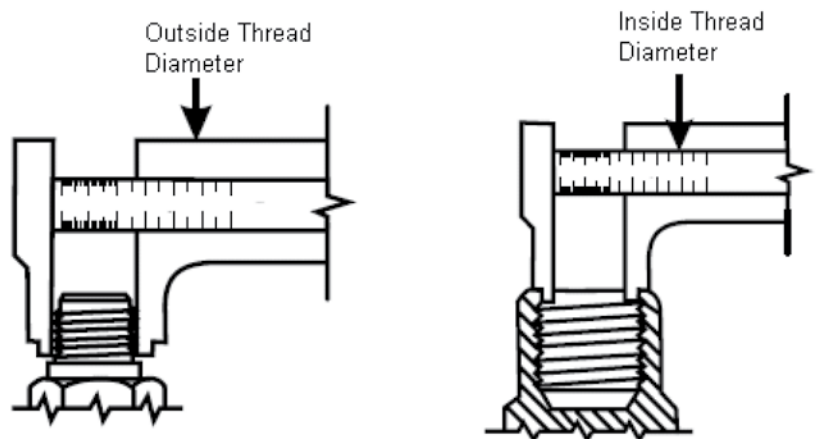

German DIN Hose Fittings (DIN – Deutsches Institut für Normung)

Often referred to as metric fittings these fittings seal using the angled sealing surfaces (metal to metal) or the combination of metal to metal with O-rings.

They are available in **very light (LL)**, **light series (L)** or **heavy series (S)**

The sealing face angles are either 24° with or without O-rings, or 24°/60° universal cones.

Identification is made by measuring the thread size and also the tube outside diameter.

Defined by the outside diameter and the pitch (distance between 2 crests of the thread)
example: M22x1.5 - pitch of 1,5mm

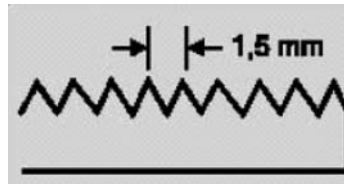

DIN Very Light Series (LL)

The male 60° cone will mate with the female 60° cone only.
The male has a 60° sealing angle (seat) and straight metric thread. The female has a 60° seat and straight metric thread.

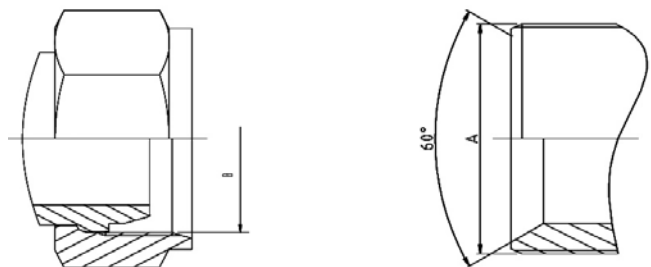

Standard
DIN 20078 Part 3 ¹⁾

Parker end configurations
C0

DN	Metric thread	ØA (mm)	ØB (mm)
20	M30x1.5	30,00	28,50
25	M38x1.5	38,00	36,50
32	M45x1.5	45,00	43,50
40	M52x1.5	52,00	50,50
50	M65x2	65,00	63,00

DIN Light (L) and Heavy Series (S) without O-ring

The male 60° cone will mate with the female universal 24° or 60° cone only.

The male has a 60° sealing angle (seat) and straight metric threads. The female has a 24° and 60° universal seat and straight metric threads.

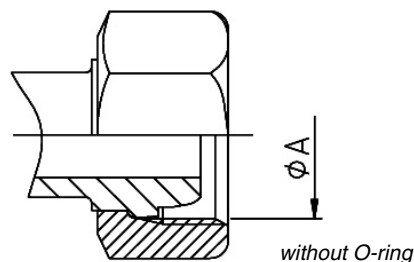

Standard
DIN 20078 Part 2 ¹⁾

(previously known as DIN 20078 A, D & E)

Parker end configurations light series:
C3, C4, C5, C6

(Often also referred to as "Ball nose cones")

¹⁾ obsolete standard, no exact replacement

**DIN 24° Light (L) and Heavy Series (S)
with O-ring**

The male has a 24° sealing angle cone seat with straight metric threads.

The female has a 24° convex cone with O-ring and a swivel straight metric threaded nut.

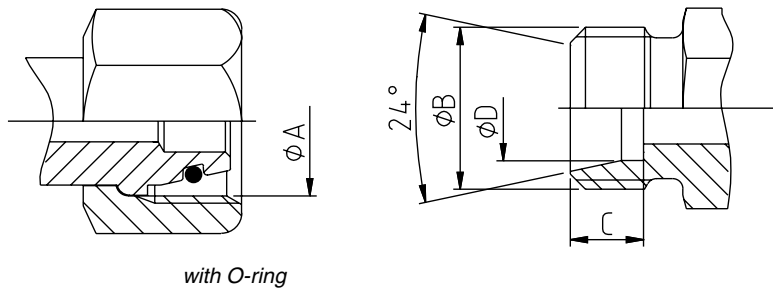

Standard
ISO 12151-2 / ISO 8434-1 & ISO 8434-4
(Previously DIN 20 078 Part 4, 5, 8, 9)

Parker end configurations light series
CA, CE, CF, D0

Parker end configurations heavy series
C9, 0C, 1C, D2

Tube OD	Specif.	Metric thread	ØA (mm)	ØB (mm)	C (mm)	ØD (mm)
6,00	6L	M12X1.5	10,50	12,00	7,00	6,20
6,00	6S	M14X1.5	12,50	14,00	7,00	6,20
8,00	8L	M14x1.5	12,50	14,00	7,00	8,20
8,00	8S	M16x1.5	14,50	16,00	7,00	8,20
10,00	10L	M16x1.5	14,50	16,00	7,00	10,20
10,00	10S	M18x1.5	16,50	18,00	7,50	10,20
12,00	12L	M18x1.5	16,50	18,00	7,00	12,20
12,00	12S	M20x1.5	18,50	20,00	7,50	12,20
14,00	14S	M22x1.5	20,50	22,00	8,00	14,20
15,00	15L	M22x1.5	20,50	22,00	7,00	15,20
16,00	16S	M24x1.5	22,50	24,00	8,50	16,20
18,00	18L	M26x1.5	24,50	26,00	7,50	18,20
20,00	20S	M30x2	27,90	30,00	10,50	20,20
22,00	22L	M30x2	27,90	30,00	7,50	22,20
25,00	25S	M36x2	33,90	36,00	12,00	25,20
28,00	28L	M36x2	33,90	36,00	7,50	28,20
30,00	30S	M42x2	39,90	42,00	13,50	30,20
35,00	35L	M45x2	42,90	45,00	10,50	35,30
38,00	38S	M52x2	49,90	52,00	16,00	38,30
42,00	42L	M52x2	49,90	52,00	11,00	42,30

British Standard Pipe (BSP)

Also referred to as Whitworth threads, the BSP thread type fittings seal using metal to metal angled surfaces or a combination of metal to metal and an O-ring.

The angle of the sealing surfaces is 60° for both forms.

There are two popular thread forms, British Standard Pipe Parallel (BSPP) and British Standard Pipe Tapered (BSPT).

Identification is made by measuring the outside diameter of the thread and the number of threads per inch (25.4 mm)

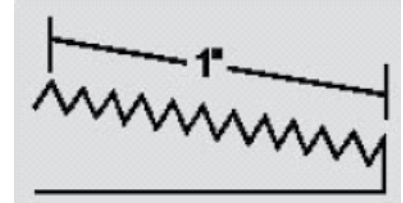

BSPP

metal to metal without O-ring

Standard
BS5200

Parker end configurations
92, B1, B2, B4, D9

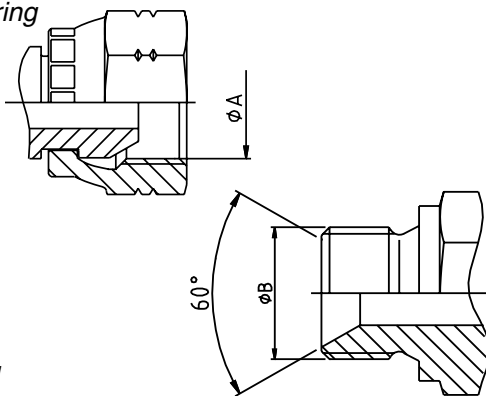

Tube OD	Size	BSP thread	ØA (mm)	ØB (mm)
6/10	-2	1/8-28	8,60	9,70
8/13	-4	1/4-19	11,50	13,20
12/17	-6	3/8-19	14,90	16,70
15/21	-8	1/2-14	18,60	20,90
18/23	-10	5/8-14	20,60	22,90
20/27	-12	3/4-14	24,10	26,40
26/34	-16	1"-11	30,30	33,20
33/42	-20	1.1/4-11	38,90	41,90
40/49	-24	1.1/2-11	44,90	47,80
50/60	-32	2-11	56,70	59,60

BSPP

metal to metal with O-ring

Standard
ISO 12151-6²⁾

Parker end configurations
EA, EB, EC, EE, D9

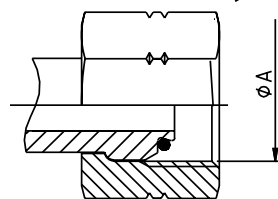

BSPT

fittings seal through the thread interface mechanism. Care should be taken not to confuse the BSPT fitting with the NPTF male fitting. BSPT has a 55° thread angle. NPTF has 60° thread angle.

Parker end configuration
91

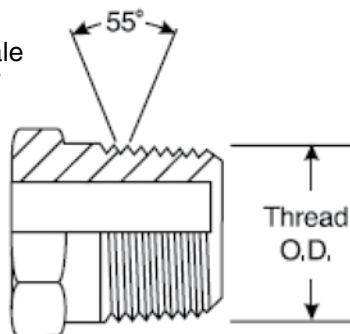

Tube	size	BSP thread	ØA (mm)
5/10	-2	1/8-28	9,73
8/13	-4	1/4-19	13,16
12/17	-6	3/8-19	16,66
15/21	-8	1/2-14	20,96
20/27	-12	3/4-14	26,44
26/34	-16	1"-11	33,25
33/42	-20	1.1/4-11	41,91
40/49	-24	1.1/2-11	47,80
50/60	-32	2-11	59,61

BSP Flat Seal

These fittings have BSP parallel threads but the sealing surface is flat. The seal is made when the composite seal is compressed against the female flat face.

Parker end configurations
B5, B6, B7

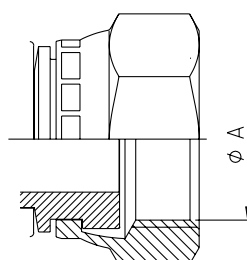

Tube OD	Size	BSP thread	ØA (mm)
6/10	-2	1/8-28	8,6
8/13	-4	1/4-19	11,5
12/17	-6	3/8-19	14,9
15/21	-8	1/2-14	18,6
18/23	-10	5/8-14	20,6
20/27	-12	3/4-14	24,1
26/34	-16	1"-11	30,3

²⁾ standard in preparation

French Metric 24° Cone Gas Fittings

Typical to the French market the French Gas fittings have a 24° sealing surfaces seat with metric straight threads. Although similar to German DIN fittings the threads differ in some sizes as the French Gas fittings have fine threads in all sizes whereas the German DIN fittings use standard threads in the larger sizes.

The sealing mechanism is metal to metal.

The fittings are not specified in any international standard.

Parker end configurations

F6, F9 (metric tube)

FG, F2, F4 (gas tube)

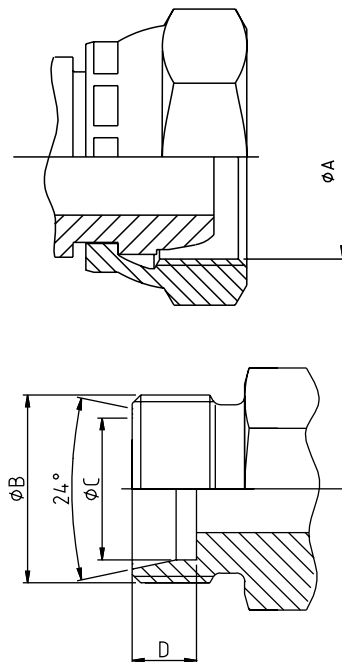

Tube OD	Specif.	Metric thread	ØA (mm)	ØB (mm)	ØC (mm)	D (mm)
6,00	6N	M12x1	11,00	12,00	6,20	9,00
8,00	8N	M14x1.5	12,50	14,00	8,15	9,00
10,00	10N	M16x1.5	14,50	16,00	10,20	9,00
12,00	12N	M18x1.5	16,50	18,00	12,15	9,00
13,25	13G	M20x1.5	18,50	20,00	13,50	9,00
14,00	14N	M20x1.5	18,50	20,00	14,15	9,00
15,00	15N	M22x1.5	20,50	22,00	15,15	9,00
16,00	16N	M24x1.5	22,50	24,00	16,15	9,00
16,75	17G	M24x1.5	22,50	24,00	17,00	9,00
18,00	18N	M27x1.5	25,50	27,00	18,15	9,00
20,00	20N	M27x1.5	25,50	27,00	20,15	9,00
21,25	21G	M30x1.5	28,50	30,00	21,50	9,00
22,00	22N	M30x1.5	28,50	30,00	22,15	9,00
25,00	25N	M33x1.5	31,50	33,00	25,15	9,00
26,75	27G	M36x1.5	34,50	36,00	27,00	9,00
28,00	28N	M36x1.5	34,50	36,00	28,25	9,00
30,00	30N	M39x1.5	37,50	39,00	30,25	9,00
32,00	32N	M42x1.5	40,50	42,00	32,25	9,00
33,25	34G	M45x1.5	43,50	45,00	33,80	9,00
35,00	35N	M45x1.5	43,50	45,00	35,25	9,00
38,00	38N	M48x1.5	46,50	48,00	38,25	9,00
40,00	40N	M52x1.5	50,50	52,00	40,35	9,00
42,25	42G	M52x1.5	50,50	52,00	42,55	9,00
48,25	49G	M58x2	55,90	58,00	49,00	11,00

Dryseal American Standard Taper Pipe Thread (NPTF)

This type of fitting uses the thread interface to seal and as such has a tapered thread that deforms and forms the seal.

They have 30° sealing angle surfaces, forming a 60° inverted (concave) seat. The fittings are most frequently seen on machines of US origin.

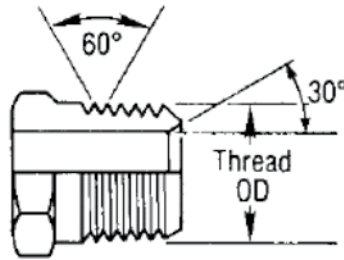

ØA dimension is measured on the 4th pitch of the thread

The NPTF male will mate with the NPTF, NPSF, or NPSM females.

Care should be taken not to confuse the NPTF fitting with the BSPT male fitting. NPTF fittings have a 60° thread angle. BSPT has a 55° thread angle.

Standard
SAE J516

Parker end configuration
01

size	NPTF thread	ØA (mm)	ØB (mm)
-2	1/8-27	10,24	8,73
-4	1/4-18	13,61	11,90
-6	3/8-18	17,05	15,90
-8	1/2-14	21,22	19,05
-12	3/4-14	26,56	24,60
-16	1-11,5	33,22	30,95
-20	1.1/4-11,5	41,98	39,69
-24	1.1/2-11,5	48,05	45,24
-32	2-11,5	60,09	57,15

SAE JIC 37°

Commonly referred to as just JIC fittings these metal to metal sealing type fittings have a 37° flare (sealing surface angle) and straight United National Fine straight Threads (UNF).

The original design specification for the fittings comes from the Society of Automotive Engineers (SAE) and these fittings are the most common American fitting type in Europe.

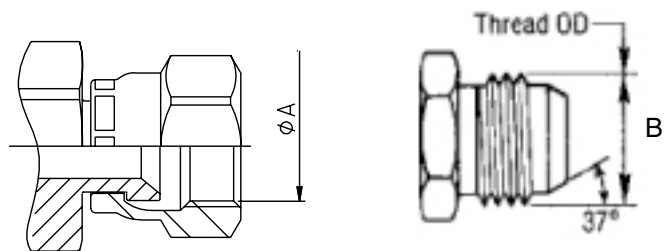

Standard
ISO 12151-5²⁾, ISO8434-2 and SAE J516

Parker JIC hose fittings are fully compatible with Parker Triple-lock Tube Fittings and adapters.

Parker end configurations
03, 06/68, 37/3V, 39/3W, 41/3Y, L9

Tube OD	Tube D (mm)	UNF thread	Size	ØA (mm)	ØB (mm)
3/16"		3/8-24	-3	8,60	9,50
1/4"	6	7/16-20	-4	10,00	11,10
5/16"	8	1/2-20	-5	11,60	12,70
3/8"	10	9/16-18	-6	13,00	14,30
1/2"	12	3/4-16	-8	17,60	19,10
5/8"	14-15-16	7/8-14	-10	20,50	22,20
3/4"	18-20	1.1/16-12	-12	24,60	27,00
7/8"	22	1.3/16-12	-14	28,30	30,10
1"	25	1.5/16-12	-16	31,30	33,30
1.1/4"	30-32	1.5/8-12	-20	39,20	41,30
1.1/2"	38	1.7/8-12	-24	45,60	47,60
2"		2.1/2-12	-32	61,50	63,50

²⁾ standard in preparation

SAE 45° Flare

The angle of the flare is commonly used as a name when referring to these metal to metal sealing fittings.

The female fittings have a 90° concave inverted seat, created by the 45° angle sealing surfaces.

The SAE 45° flare male will mate with an SAE 45° flare female only or a dual seat JIC 37°/SAE45°.

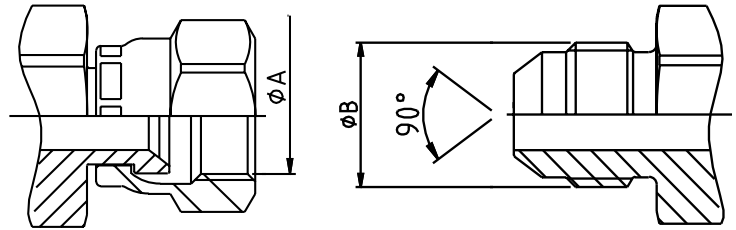

Standard
SAE J516

Parker end configurations
04, 08/68, 77/3V, 79/3W, 81/3Y

Tube OD	Size	UNF thread	ØA (mm)	ØB (mm)
1/4"	-4	7/16-20	9,90	11,10
5/16"	-5	1/2-20	11,50	12,70
3/8"	-6	5/8-18	14,30	15,90
1/2"	-8	3/4-16	17,50	19,10
5/8"	-10	7/8-14	20,60	22,20
3/4"	-12	1.1/16-14	25,00	27,00

SAE O-ring (Boss Type)

This male fitting has straight threads, a sealing face and an O-ring. It is compatible only with female boss type fittings generally found in the ports of the machines. Sealing is achieved through the O-ring of the male and through the sealing face of the female.

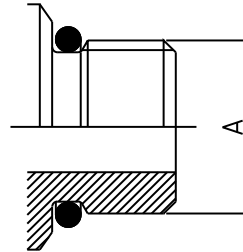

Parker end configuration
05

UNF thread	size	ØA (mm)
5/16-24	-2	7,93
3/8-24	-3	9,52
7/16-20	-4	11,11
1/2-20	-5	12,70
9/16-18	-6	14,28
3/4-16	-8	19,10
7/8-14	-10	22,22
1.1/16-12	-12	27,00
1.3/16-12	-14	30,10
1.5/16-12	-16	33,30
1.5/8-12	-20	41,30
1.7/8-12	-24	47,60
2.1/2-12	-32	63,50

O-ring Face Seal (ORFS)

ORFS fittings are becoming the most popular international fitting type used on global OEM machines due to their high level of sealing and their good vibration resistance. The fittings use the O-ring compression mechanism to seal. The female fittings have flat faces and straight threaded UNF swivel nuts. The male fittings have the O-ring in a groove in the flat face.

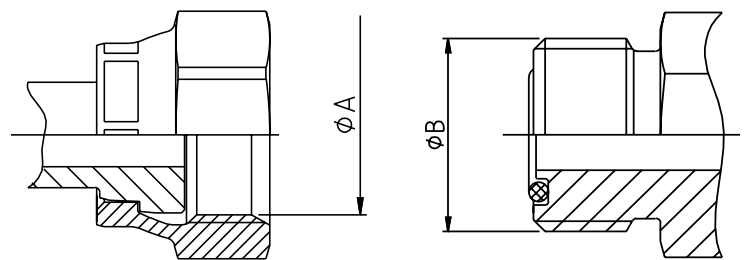

Seen as a major advantage, these fittings offer the possibility to build the hose assemblies into fixed distances/spaces, without having to move back other system components due the flat faces of the male and female fittings – the hose assembly can be slotted in.

Standard
ISO 12151-1, ISO8434-3 and SAE J516

Parker end configurations
JC, JM/J0, JS, JU, J1, J3, J5, J7, J9

Tube OD	Tube D (mm)	UNF thread	Size	ØA (mm)	ØB (mm)
1/4"	6	9/16-18	-4	13,00	14,20
3/8"	10	11/16-16	-6	15,90	17,50
1/2"	12	13/16-16	-8	19,10	20,60
5/8"	16	1-14	-10	23,80	25,40
3/4"	20	1.3/16-12	-12	28,20	30,10
1"	25	1.7/16-12	-16	34,15	36,50
1.1/4"	32	1.11/16-12	-20	40,50	42,90
1.1/2"	38	2-12	-24	48,80	50,80

Flange Fittings
Code 61 and Code 62

The 4-bolt split flange (or full flange) fitting is used worldwide for connecting high pressure hoses typically to pumps, motors and cylinders, where the hose assemblies are subjected to large pressure loadings. The sealing mechanism is through compression of the O-ring in the face of the flange head against the surface of the port/ connection.

The flange fittings are generally separated into two pressure classes referred to as 3000 psi (SFL) or 6000 psi (SFS). ISO 12151-3 refers to the flange fittings as code 61 for the 3000 psi and code 62 for the 6000 psi.

In addition to these flanges, customer specific Komatsu® and CATERPILLAR® flanges can also be found in the market.

Parker end configurations

Code 61 (3000 psi)

15, 16, 17, 19, P5, P7, P9

5000 psi (Code 61 dimensions)

4A, 4F, 4N

Code 62 (6000 psi)

6A, 6F, 6N, PA, PF, PN, 89

Caterpillar flange

XA, XF, XG, XN

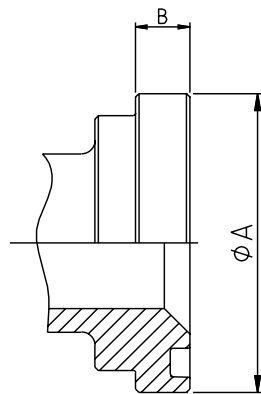

- Standard Code 61 for 3000 to 5000 psi max., depending on size
- High Pressure Code 62 for 6000 psi max. regardless of size

Flange (inch)	size	code 61	Code 62
1/2	-8	34,5 / 5000	41,3/ 6000
3/4	-12	34,5/ 5000	41,3/ 6000
1	-16	34,5/ 5000	41,3/ 6000
1.1/4	-20	27,5/ 4000	41,3/ 6000
1.1/2	-24	20,7/ 3000	41,3/ 6000
2	-32	20,7/3000	41,3/ 6000

Code 61 - SAE 3000PSI

Flange (inch)	Size	ØA (mm)	B (mm)	O-Ring
1/2"	-8	30,18	6,73	18,64x3,53
3/4"	-12	38,10	6,73	24,99x3,53
1"	-16	44,45	8,00	32,92x3,53
1.1/4"	-20	50,80	8,00	37,69x3,53
1.1/2"	-24	60,33	8,00	47,22x3,53
2"	-32	71,42	9,53	56,74x3,53
2.1/2"	-40	84,12	9,53	69,44x3,53
3"	-48	101,60	9,53	85,32x3,53

Code 62 - SAE 6000 PSI

Flange (inch)	Size	ØA (mm)	B (mm)	O-Ring
1/2"	-8	31,75	7,75	18,64x3,53
3/4"	-12	41,28	8,76	24,99x3,53
1"	-16	47,63	9,53	32,92x3,53
1.1/4"	-20	53,98	10,29	37,69x3,53
1.1/2"	-24	63,50	12,57	47,22x3,53
2"	-32	79,38	12,57	56,74x3,53

CATERPILLAR®

Flange (inch)	Size	ØA (mm)	B (mm)	D-Ring
3/4"	-12	41,28	14,22	25,40x5,00
1"	-16	47,63	14,22	31,90x5,00
1.1/4"	-20	53,98	14,22	38,20x5,00
1.1/2"	-24	63,50	14,22	44,70x5,00

Although not in the SAE or the ISO norm the size -10 (5/8) flange head is gaining popularity. This flange is often found on Komatsu equipment or hydrostatic drives in agricultural machines.

Flange (inch)	Size	ØA (mm)	B (mm)	O-Ring
5/8"	-10	34,25	6,00	21,7x3,5

4-Bolt Split Flange

A 4-bolt split flange is used to attach the flange fittings to their ports.

- Standard Code 61
for 3000 to 5000 psi max., depending on size
- High Pressure Code 62
for 6000 psi max. regardless of size

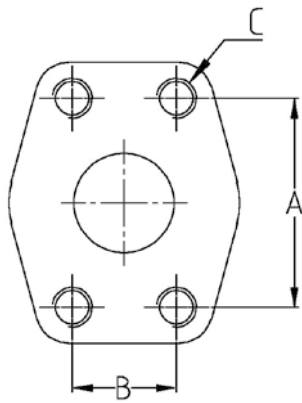

port dimensions

CODE 61 - SAE 3000 psi

Flange	Size	A (mm)	B (mm)	C	
				(inch)	(metr.)
1/2"	-8	38.1	17.5	5/16-18	M8x1,25
3/4"	-12	47.6	22.3	3/8-16	M10x1,5
1"	-16	52.4	26.2	3/8-16	M10x1,5
1-1/4"	-20	58.7	30.2	7/16-14	M10x1,5
1-1/2"	-24	69.9	35.7	1/2-13	M12x1,75
2"	-32	77.8	42.8	1/2-13	M12x1,75*

CODE 62 - SAE 6000 psi

Flange	Size	A (mm)	B (mm)	C	
				(inch)	(metr.)
1/2"	-8	40.5	18.2	5/16-18	M8x1,25
3/4"	-12	50.8	23.8	3/8-16	M10x1,5
1"	-16	57.2	27.8	7/16-14	M12x1,75
1-1/4"	-20	66.7	31.8	1/2-13	M12x1,75*
1-1/2"	-24	79.4	36.5	5/8-11	M16x2
2"	-32	96.8	44.4	3/4-10	M20x2,5

*M14x2 still used in the market but no longer in accordance with ISO6162

Japanese fittings - JIS

Japanese Industrial Standard (JIS) are seen on most Japanese equipment and use a 30° sealing angle seat and either British Standard Pipe Parallel or metric threads. Care must be taken not to confuse the JIS fittings with BSP or JIC fittings. The sealing mechanism of the fittings is the 30° metal to metal angled surfaces

Parker end configurations

MU, XU (Metric)

FU (BSP)

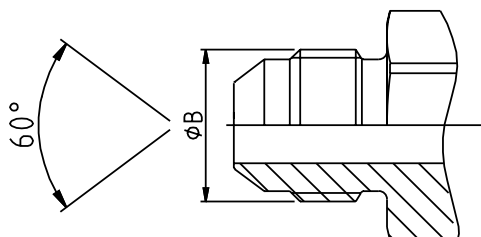
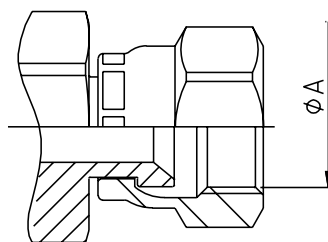

JIS 30° metric

	Symbol	Metric thread	ØA (mm)	ØB (mm)
	MU-6	M14x1.5	12,50	14,00
	MU-9	M18x1.5	16,50	18,00
	MU-12	M22x1.5	20,50	22,00
	MU-15	M27x2	25,00	27,00
	MU-19	M27x2	25,00	27,00
	MU-25	M33x2	31,00	33,00
	MU-32	M42x2	40,00	42,00
	MU-38	M50x2	48,00	50,00
	MU-50	M60x2	58,00	60,00

JIS 30° BSP

	Symbol	BSP thread	ØA (mm)	ØB (mm)
	GUI-3	1/8-28	8,60	9,70
	GUI-5/6	1/4-19	11,50	13,20
	GUI-8/9	3/8-19	14,90	16,70
	GUI-12	1/2-14	18,60	20,90
	GUI-15/19	3/4-14	24,10	26,40
	GUI-25	1"-11	30,30	33,20
	GUI-32	1.1/4-11	38,90	41,90
	GUI-38	1.1/2-11	44,90	47,80
	GUI-50	2-11	56,70	59,60



aerospace
climate control
electromechanical
filtration
fluid & gas handling
hydraulics
pneumatics
process control
sealing & shielding



Hydraulic Hose, Fittings and Equipment

Low Pressure



ENGINEERING YOUR SUCCESS.

Low Pressure Push-Lok® Hose and Fittings

**- the self-grip hose system for
low pressure applications**

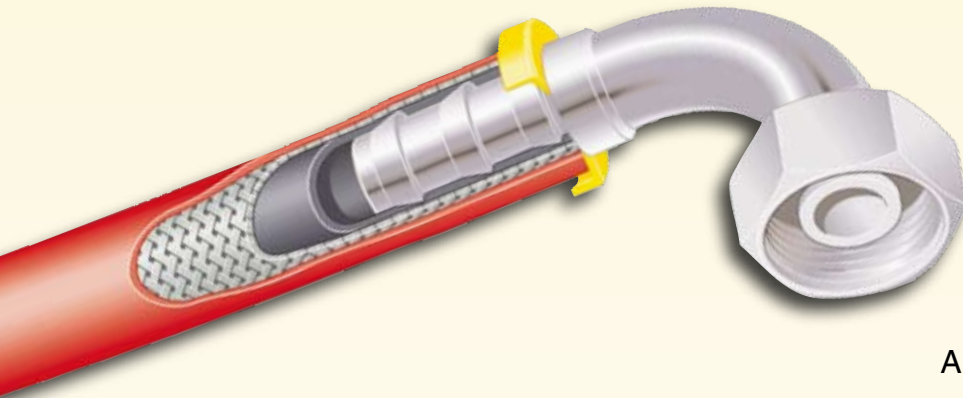

The Push-Lok® range offers a wide selection of different hose types in rubber and thermoplastic as well as a hybrid version.

All hose materials are available in 6 different colours. The hose range is complete with end configurations in DIN, BSP, SAE, JIC and ORFS in brass, steel and

Parker Push-Lok® – world-wide market leader for the following good reasons:

- ▶ **Easy assembly**
 - no tools or clamps required
- ▶ **Wide variety of hose types**
 - 6 rubber hose types
 - 2 thermoplastic hoses
 - 1 hybrid hose
- ▶ **6 colours for**
 - easy identification
 - simple production processes
... a colour for a particular medium
 - easy control of maintenance intervals
 - simple stock planning in different departments
- ▶ **One fitting series for all hose types**
 - with DIN, BSP, SAE, JIC and ORFS connections in brass, steel and stainless steel

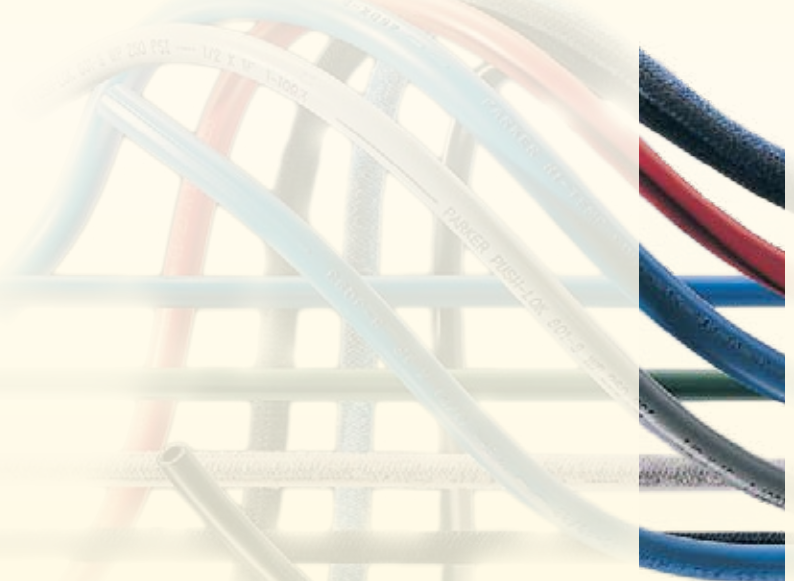

Push-Lok®

– a high quality low pressure hose system approved world-wide



Push-Lok® assembly

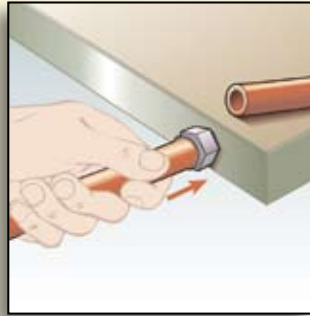

- Cut the hose with a sharp knife
- Push the nipple into the hose – that's all!

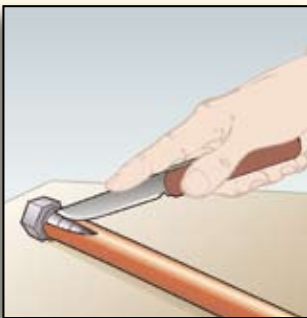

Push-Lok® disassembly



- Cut lengthwise along a line at approximately a 20° angle from centre line of hose. The cut should be approximately 2 cm long. Be careful not to nick barbs when cutting the hose.
- Grip hose and give a sharp downward tug to disengage from fitting.
- Before re-using the nipple please check it for any damage.

Push-Lok® hoses offer variety, excellent performance and durability for the following applications

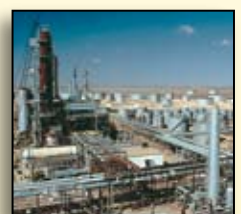

Index

Push-Lok Hoses

B1

801	– Push-Lok Hose	B1a-1
804	– Push-Lok Hose	B1a-2
821FR	– Push-Lok Hose	B1a-3
830M	– Push-Lok Hose	B1a-4
831	– Push-Lok Hose	B1a-5
836	– Push-Lok Hose	B1a-6
837BM	– Push-Lok Hose	B1a-7
837PU	– Hybrid Push-Lok Hose	B1a-8
838M	– Push-Lok Hose	B1a-9
Push-Lok Fittings: 82 Series		B1b-1–B1b-37
Assembly Instructions for Push-Lok Fittings		B1b-39
Assembly Tools		B1b-39

801 – Push-Lok Hose

For a variety of applications

Main Features

- Very flexible
- Wide range of colours
- Available up to size -16

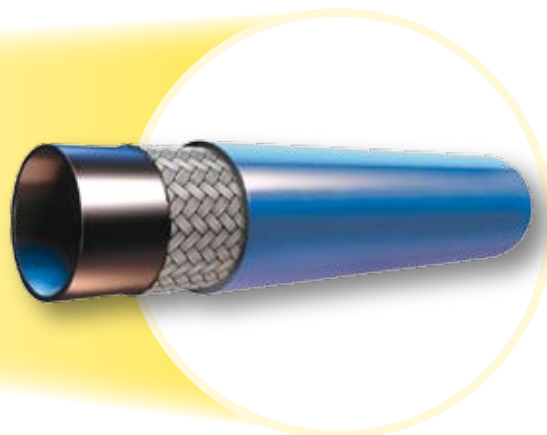

Primary Applications/Restrictions

All Markets: For light applications
Paper and Pulp: For water / air applications
Not permitted for use in air brake systems.
Not suitable for high dynamic pulsation systems.
Not recommended for motor fuels.

Hose Construction

Tube: Synthetic rubber
Reinforcement: High tensile textile layer
Cover: High performance synthetic rubber in different colours

Recommended Fluids

Air, dry air, water, water-oil-emulsions and water-glycol-emulsions. (Mineral based hydraulic and lubricating oils with chemical and thermal (70 °C) restriction). Consult the chemical compatibility section on page Ab-16 for more detailed information.

Temperature Range

-40 °C up to +100 °C
 Exception: Air max. +70 °C
 Water max. +85 °C

Fittings Series



XXXX-XX-XX Part Number	Hose I.D.				Hose O.D.	Pressure rating				Vacuum kilo Pascal*1 kPa	min. bend radius mm	Weight kg/m
	DN	Inch	Size	mm	mm	max. dynamic working pressure	min. burst pressure	MPa	psi			
801-4-XXX-RL	6	1/4	-4	6,3	12,7	1,7	250	6,8	1000	95	65	0,13
801-6-XXX-RL	10	3/8	-6	9,5	15,9	1,7	250	6,8	1000	95	75	0,16
801-8-XXX-RL	12	1/2	-8	12,7	19,8	1,7	250	6,8	1000	95	130	0,27
801-10-XXX-RL	16	5/8	-10	15,9	23,0	1,7	250	6,8	1000	51	150	0,28
801-12-XXX-RL	20	3/4	-12	19,1	26,2	1,7	250	6,8	1000	51	180	0,36
801-16-XXX-RL	25	1	-16	25,4	32,5	1,2	175	4,8	700	51	250	0,55

*1 = the vacuum values listed in the table are vacuum pressure values in kPa. For an absolute value subtract the table value from 101 kPa
 Note: when ordering, specify Push-Lok hose part number, followed by size, followed by colour. Example: 801-4-XXX-RL

- XXX = BLK = black
 BLU = blue
 RED = red
 GRN = green
 GRA = grey



Example: 801-4-GRN-RL (green)
 RL = only available on reels
 801-16-XXX-RL is only available in grey or black

Information about standard products or non-standard products can be found in the current price list.
 Dimensions shown may be changed at any time without prior notice.

804 – Push-Lok Hose

For high temperature water / phosphate ester fluid

Main Features

- For hot water up to +93 °C
- For phosphate ester fluids



Primary Applications/Restrictions

Injection Moulding: For special tempering circuits.
Not permitted for use in air brake systems.
Not suitable for high dynamic pulsation systems.
Do not allow tube to contact any petroleum based fluids.

Hose Construction

Tube: EPDM material
Reinforcement: High tensile textile layer
Cover: Black EPDM material

Recommended Fluids

Phosphate ester based hydraulic fluids, *water, *water glycol emulsions, air. Use liquid soap as lubricant. Consult the chemical compatibility section on page Ab-16 for more detailed information.

Temperature Range

up to +80 °C
 Exception: Air max. +70 °C
 *Water max. + 93 °C

Fittings Series



XXXX-XX-XX Part Number	Hose I.D.				Hose O.D.	Pressure rating				min. bend radius mm	Weight kg/m
	DN	Inch	Size	mm	mm	max. dynamic working pressure		min. burst pressure			
						MPa	psi	MPa	psi		
804-4-RL	6	1/4	-4	6,3	12,7	0,9	125	3,4	500	65	0,13
804-6-RL	10	3/8	-6	9,5	15,9	0,9	125	3,4	500	75	0,16
804-8-RL	12	1/2	-8	12,7	19,8	0,9	125	3,4	500	130	0,27
804-12-RL	20	3/4	-12	19,1	26,2	0,9	125	3,4	500	180	0,36

RL = only available on reels

Information about standard products or non-standard products can be found in the current price list. Dimensions shown may be changed at any time without prior notice.

821FR – Push-Lok Hose

With fire retardant hose cover

Main Features

- Fire retardant hose cover
- Very flexible
- For high level air temperatures

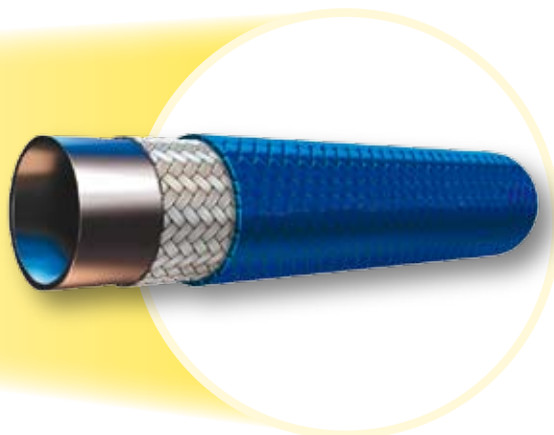

Primary Applications/Restrictions

All Markets: For a variety of applications
Not permitted for use in air brake systems.
Not suitable for high dynamic pulsation systems.
Not recommended for motor fuels.

Hose Construction

Tube: Synthetic PKR-rubber
Reinforcement: High tensile textile layer
Cover: A fire retardant special fiber outer cover

Recommended Fluids

Mineral based hydraulic and lubricating oils, coolant, antifreeze, air, water and water-oil emulsions. Consult the chemical compatibility section on page Ab-16 for more detailed information.

Temperature Range

-40 °C up to +100 °C
 Exception: Airmax. +100 °C
 Watermax. +85 °C

Fittings Series



XXXX-XX-XX Part Number	Hose I.D.				Hose O.D. mm	Pressure rating				Vacuum kilo Pascal*1 kPa	min. bend radius mm	Weight kg/m
	DN	Inch	Size	mm		max. dynamic working pressure		min. burst pressure				
						MPa	psi	MPa	psi			
821FR-4-XXX-RL	6	1/4	-4	6,3	12,7	2,4	350	9,7	1400	95	65	0,12
821FR-6-XXX-RL	10	3/8	-6	9,5	15,9	2,0	300	8,3	1200	95	75	0,16
821FR-8-XXX-RL	12	1/2	-8	12,7	19,8	2,0	300	8,3	1200	95	130	0,18
821FR-12-XXX-RL	20	3/4	-12	19,1	26,2	1,7	250	6,8	1000	95	180	0,33

*1 = the vacuum values listed in the table are vacuum pressure values in kPa. For an absolute value subtract the table value from 101 kPa
 Note: when ordering, specify Push-Lok hose part number, followed by size, followed by colour. Example: 821FR-4-XXX-RL

XXX = BLK = black
 BLU = blue
 GRN = green
 WHT = white
 BRN = brown



Example: 821FR-4-GRN-RL (green)
 RL = only available on reels

Information about standard products or non-standard products can be found in the current price list.
 Dimensions shown may be changed at any time without prior notice.

830M – Push-Lok Hose

For a variety of applications including automotive

Main Features

- Chemical resistant for a wide range of fluids
- High abrasion resistance
- Free of wetting disturbing substances
- Small OD and bend radii

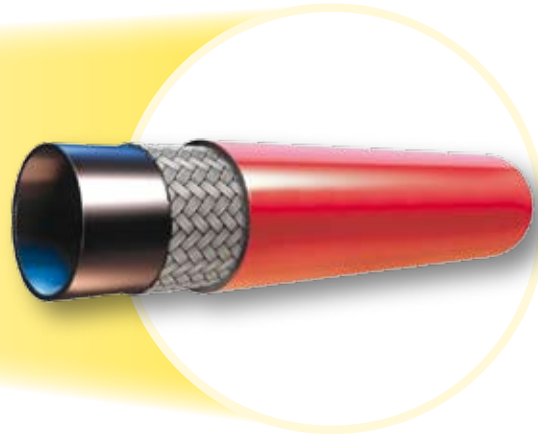

Primary Applications/Restrictions

All Markets: For a variety of applications

Robot and Automotive market:

For hose bundle systems

Not permitted for use in air brake systems.

Not suitable for high dynamic pulsation systems.

Not recommended for motor fuels.

Hose Construction

Tube: Polyurethane material

Reinforcement: High tensile textile layer

Cover: High performance polyurethane material in different colours

Recommended Fluids

Mineral based hydraulic and lubricating oils, coolant, antifreeze, air, water and water-oil emulsions.

Consult the chemical compatibility section on page Ab-16 for more detailed information.

Temperature Range -40 °C up to +80 °C

Fittings Series



Part Number XXXX-XX-XX	Hose I.D.				Hose O.D. mm	Pressure rating				Vacuum kilo Pascal*1 kPa	min. bend radius mm	Weight kg/m
	DN	Inch	Size	mm		max. dynamic working pressure MPa	psi	min. burst pressure MPa	psi			
830M-4-XXX-RL	6	1/4	-4	6,3	10,7	1,6	232	6,4	928	10	30	0,08
830M-6-XXX-RL	10	3/8	-6	9,5	14,9	1,6	232	6,4	928	10	50	0,13
830M-8-XXX-RL	12	1/2	-8	12,7	19,1	1,6	232	6,4	928	10	70	0,20
830M-10-XXX-RL	16	5/8	-10	16,0	23,0	1,6	232	6,4	928	10	90	0,26
830M-12-XXX-RL	20	3/4	-12	19,0	26,0	1,6	232	6,4	928	10	110	0,31

*1 = the vacuum values listed in the table are vacuum pressure values in kPa. For an absolute value subtract the table value from 101 kPa

Note: when ordering, specify Push-Lok hose part number, followed by size, followed by colour. Example: 830M-4-XXX-RL

XXX = BLK = black
 BLU = blue
 RED = red
 GRN = green



Example: 830M-4-GRN-RL (green)

RL = only available on reels

Information about standard products or non-standard products can be found in the current price list. Dimensions shown may be changed at any time without prior notice.

831 – Push-Lok Hose

Ideal for petroleum based fluids

Main Features

- Max. working pressure up to 2,4 MPa
- High temperature level for petroleum based fluids
- Nitrile (NBR) inner tube – extended fluid compatibility

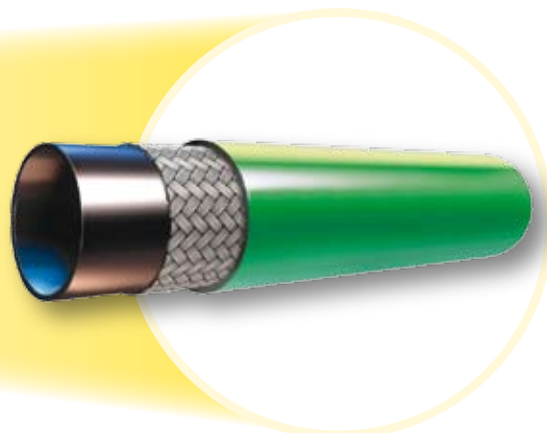

Primary Applications/Restrictions

All Markets: For a wide range of fluids
Not permitted for use in air brake systems.
Not suitable for high dynamic pulsation systems.
Not recommended for motor fuels.

Hose Construction

Tube: Synthetic rubber
Reinforcement: High tensile textile layer
Cover: High performance synthetic rubber in different colours

Recommended Fluids

Mineral based hydraulic and lubricating oils, coolant, antifreeze, air, water and water-oil emulsions. Consult the chemical compatibility section on page Ab-16 for more detailed information.

Temperature Range

-40 °C up to +100 °C
 Exception: Air max. +70 °C
 Water max. +85 °C

Fittings Series



Part Number XXXX-XX-XX	Hose I.D.				Hose O.D. mm	Pressure rating				Vacuum kilo Pascal*1 kPa	min. bend radius mm	Weight kg/m
	DN	Inch	Size	mm		max. dynamic working pressure		min. burst pressure				
						MPa	psi	MPa	psi			
831-4-XXX-RL	6	1/4	-4	6,3	12,7	2,4	350	9,7	1400	95	65	0,13
831-6-XXX-RL	10	3/8	-6	9,5	15,9	2,0	300	8,3	1200	95	75	0,16
831-8-XXX-RL	12	1/2	-8	12,7	19,8	2,0	300	8,3	1200	95	130	0,27
831-10-XXX-RL	16	5/8	-10	15,9	23,0	2,0	300	8,3	1200	51	150	0,28
831-12-XXX-RL	20	3/4	-12	19,1	26,2	2,0	300	8,3	1200	51	180	0,36

*1 = the vacuum values listed in the table are vacuum pressure values in kPa. For an absolute value subtract the table value from 101 kPa

Note: when ordering, specify Push-Lok hose part number, followed by size, followed by colour. Example: 831-4-XXX-RL

XXX = BLK = black

BLU = blue

RED = red

GRN = green



Example: 831-4-GRN-RL (green)

RL = only available on reels

Information about standard products or non-standard products can be found in the current price list. Dimensions shown may be changed at any time without prior notice.

836 – Push-Lok Hose

For high oil temperatures

Main Features

- Max. oil temperature up to +150 °C
- Blue hose cover

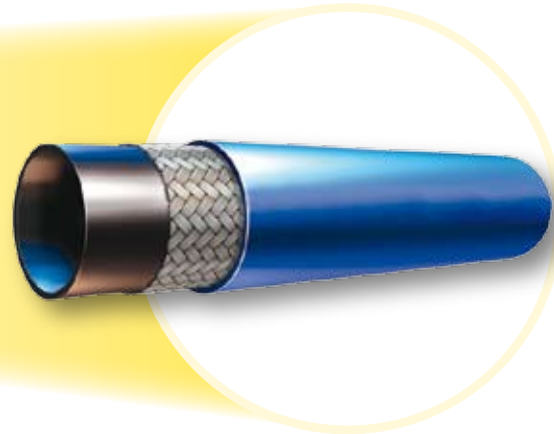

Primary Applications/Restrictions

All Markets: Special high temperature applications
Not permitted for use in air brake systems.
Not suitable for high dynamic pulsation systems.
Not recommended for motor fuels.

Hose Construction

Tube: Synthetic PKR rubber
Reinforcement: High tensile textile layer
Cover: Blue synthetic PKR rubber

Recommended Fluids

Mineral based hydraulic and lubricating oils, coolant, antifreeze, air, water and water-oil emulsions. Consult the chemical compatibility section on page Ab-16 for more detailed information.

Temperature Range

-48 °C up to +150 °C

Exception: Air max. +100 °C
 Water max. +85 °C

Fittings Series



Part Number XXXX-XX-XX	Hose I.D.				Hose O.D. mm	Pressure rating				Vacuum kilo Pascal*1 kPa	min. bend radius mm	Weight kg/m
	DN	Inch	Size	mm		max. dynamic working pressure MPa	psi	min. burst pressure MPa	psi			
836-4-RL	6	1/4	-4	6,3	12,7	1,7	250	6,8	1000	95	65	0,13
836-6-RL	10	3/8	-6	9,5	15,7	1,7	250	6,8	1000	95	75	0,16
836-8-RL	12	1/2	-8	12,7	19,8	1,7	250	6,8	1000	95	130	0,27
836-10-RL	16	5/8	-10	15,9	23,1	1,7	250	6,8	1000	51	150	0,28
836-12-RL	20	3/4	-12	19,1	26,2	1,7	250	6,8	1000	51	180	0,36

*1 = the vacuum values listed in the table are vacuum pressure values in kPa. For an absolute value subtract the table value from 101 kPa
 RL = only available on reels

Information about standard products or non-standard products can be found in the current price list. Dimensions shown may be changed at any time without prior notice.

837BM – Push-Lok Hose

For a variety of applications including automotive

Main Features

- High level of hose flexibility
- High abrasion resistant
- Free of wetting disturbing substances
- Low push-in forces



Primary Applications/Restrictions

All Markets: For a variety of applications
Automotive: For water / air applications
Not permitted for use in air brake systems.
Not suitable for high dynamic pulsation systems.
Not recommended for motor fuels.

Hose Construction

Tube: Synthetic rubber
Reinforcement: High tensile textile layer
Cover: High performance synthetic rubber in different colours

Recommended Fluids

Air, dry air, water, water-oil-emulsions and water-glycol-emulsions. (Mineral based hydraulic and lubricating oils with chemical and thermal (70 °C) restriction). Consult the chemical compatibility section on page Ab-16 for more detailed information.

Temperature Range

-40 °C up to +100 °C
 Exception: Air max. +70 °C
 Water max. +85 °C

Fittings Series



XXXX-XX-XX Part Number	Hose I.D.				Hose O.D. mm	Pressure rating				Vacuum kilo Pascal*1 kPa	min. bend radius mm	Weight kg/m
	DN	Inch	Size	mm		max. dynamic working pressure		min. burst pressure				
						MPa	psi	MPa	psi			
837BM-4-XXX-RL	6	1/4	-4	6,3	12,7	1,6	235	6,4	940	95	65	0,13
837BM-6-XXX-RL	10	3/8	-6	9,5	15,9	1,6	235	6,4	940	95	75	0,16
837BM-8-XXX-RL	12	1/2	-8	12,7	19,8	1,6	235	6,4	940	95	130	0,27
837BM-10-XXX-RL	16	5/8	-10	15,9	23,0	1,6	235	6,4	940	51	150	0,28
837BM-12-XXX-RL	20	3/4	-12	19,1	26,2	1,6	235	6,4	940	51	180	0,36

*1 = the vacuum values listed in the table are vacuum pressure values in kPa. For an absolute value subtract the table value from 101 kPa
 Note: when ordering, specify Push-Lok hose part number, followed by size, followed by colour. Example: 837BM-4-XXX-RL

XXX = BLK = black
 BLU = blue
 RED = red
 GRN = green
 GRA = grey



Example: 837BM-4-GRN-RL (green)
 RL = only available on reels

Information about standard products or non-standard products can be found in the current price list.
 Dimensions shown may be changed at any time without prior notice.

837PU-Plus – Hybrid Push-Lok Hose

For a variety of applications including automotive

Main Features

- High level of hose flexibility
- High abrasion resistance
- High torsion resistance
- Free of wetting disturbing substances
- Low push-in forces

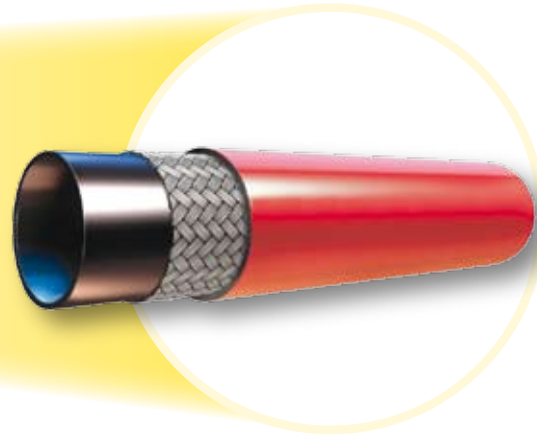

Primary Applications/Restrictions

All Markets: For high demanding applications
For energy chain systems

Robot and Automotive market:
For hose bundle systems

*Not permitted for use in air brake systems.
Not suitable for high dynamic pulsation systems.
Not recommended for motor fuels.*

Hose Construction

Tube: Synthetic rubber
Reinforcement: High tensile textile layer
Cover: High performance polyurethane material in different colours

Recommended Fluids

Air, dry air, water, water-oil-emulsions and water-glycol-emulsions. (Mineral based hydraulic and lubricating oils with chemical and thermal (70 °C) restriction).
Consult the chemical compatibility section on page Ab-16 for more detailed information.

Temperature Range

-40 °C up to +100 °C

Exception: Air max. +70 °C
Water max. +85 °C

Fittings Series



Part Number XXXX-XX-XX	Hose I.D.				Hose O.D. mm	Pressure rating				Vacuum kilo Pascal*1 kPa	min. bend radius mm	Weight kg/m
	DN	Inch	Size	mm		max. dynamic working pressure MPa	psi	min. burst pressure MPa	psi			
837PU-4-xxx-RL	6	1/4	-4	6,3	12,7	1,6	235	6,4	940	95	30	0,11
837PU-6-xxx-RL	10	3/8	-6	9,5	15,9	1,6	235	6,4	940	95	50	0,15
837PU-8-xxx-RL	12	1/2	-8	12,7	19,8	1,6	235	6,4	940	95	70	0,26
837PU-10-xxx-RL	16	5/8	-10	15,9	23,0	1,6	235	6,4	940	51	90	0,27
837PU-12-xxx-RL	20	3/4	-12	19,1	26,2	1,6	235	6,4	940	51	110	0,33

*1 = the vacuum values listed in the table are vacuum pressure values in kPa. For an absolute value subtract the table value from 101 kPa
Note: when ordering, specify Push-Lok hose part number, followed by size, followed by colour. Example: 837PU-4-XXX-RL

XXX = BLK = black
BLU = blue
RED = red
GRN = green
GRA = grey



Example: 837PU-4-GRN-RL (green)
RL = only available on reels

Information about standard products or non-standard products can be found in the current price list.
Dimensions shown may be changed at any time without prior notice.

838M – Push-Lok Hose

For non conductive applications

Main Features

- Non conductive hose

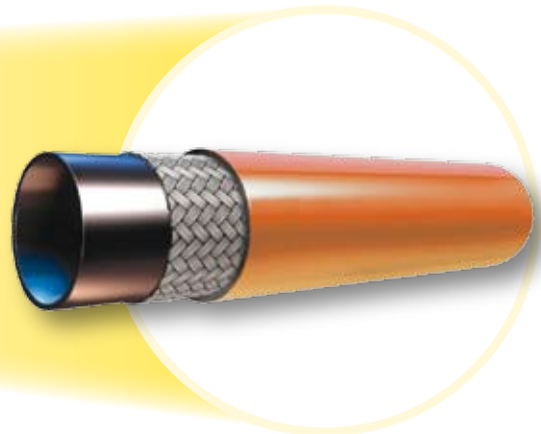

Primary Applications/Restrictions

Special Market: For special electrical requirements
Not permitted for use in air brake systems.
Not suitable for high dynamic pulsation systems.
Not recommended for motor fuels.

Hose Construction

Tube: Polyurethane material
Reinforcement: High tensile textile layer
Cover: Orange coloured polyurethane material

Recommended Fluids

Mineral based hydraulic and lubricating oils, coolant, antifreeze, water, water-oil emulsions.
 Consult the chemical compatibility section on page Ab-16 for more detailed information.

Temperature Range -40 °C up to +80 °C

Fittings Series























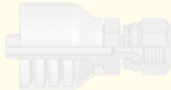

XXXX-XX-XX Part Number	Hose I.D.				Hose O.D. mm	Pressure rating				Vacuum kilo Pascal*1 kPa	min. bend radius mm	Weight kg/m
	DN	Inch	Size	mm		max. dynamic working pressure		min. burst pressure				
						MPa	psi	MPa	psi			
838M-4-RL	6	1/4	-4	6,3	11,2	1,6	232	6,4	928	10	30	0,08
838M-6-RL	10	3/8	-6	9,5	15,0	1,6	232	6,4	928	10	50	0,13
838M-8-RL	12	1/2	-8	12,7	19,1	1,6	232	6,4	928	10	70	0,20
838M-10-RL	16	5/8	-10	15,9	23,0	1,6	232	6,4	928	10	90	0,26
838M-12-RL	20	3/4	-12	19,1	26,0	1,6	232	6,4	928	10	110	0,31

















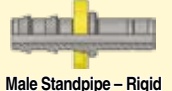

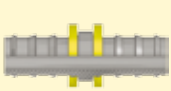
*1 = the vacuum values listed in the table are vacuum pressure values in kPa. For an absolute value subtract the table value from 101 kPa
 RL = only available on reels

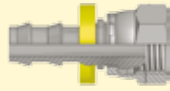
Information about standard products or non-standard products can be found in the current price list.
 Dimensions shown may be changed at any time without prior notice.

Fittings Overview 82 Series

DIN	CA B1b-6  DKOL	CE B1b-7  DKOL 45°	CF B1b-8  DKOL 90°	DO B1b-9  CEL	C0  DKM or DKLL	C3 B1b-1  DKL	C4 B1b-2  DKL 45°	
	C5 B1b-3  DKL 90°	1D B1b-10  BEL	DD  BEL 45°	5D  BEL 90°	C9  DKOS	0C  DKOS 45°	1C  DKOS 90°	
	D2  CES	C6  DKS	3D  BES	49 B1b-34  Metric Banjo	9B B1b-4  Swivel Female 45° Elbow	9C B1b-5  Swivel Female 90° Elbow		
BSP	92 B1b-14  DKR	B1 B1b-15  DKR 45°	B2 B1b-16  DKR 90°	B4  DKR 90° (Compact)	EA  DKOR	EB  DKOR 45°	EC  DKOR 90°	
	D9 B1b-17  AGR	91 B1b-18  AGR-K	B5  Female BSP Parallel Pipe - Swivel (Flat Seat)	34 B1b-19  Standpipe				
SAE	01 B1b-20  AGN	02 B1b-22  Female NPTF Pipe Rigid - Straight	03 B1b-23  AGJ	04  Male SAE 45° - Rigid	05  Male SAE Straight Thread with O-ring - Rigid	06 B1b-24 68  DKJ	08 B1b-27 	
	13 B1b-21  Male NPTF Pipe Swivel	33  Male JIC 37° - Rigid	37 B1b-25 3V  DKJ 45°	39 B1b-26 3W  DKJ 90°	41 3Y  DKJ 90°L	L9  DKJ 90° M	93  Female JIC 37° - Swivel (Block Type)	
Flange	15 4A  SFL	16  SFL 22.5°	17 4F  SFL 45°	19 4N  SFL 90°	6A  SFS	6F  SFS 45°	6N  SFS 90°	
	89  SFL 90° - long	XA  Caterpillar Flange Head	XF  Caterpillar Flange Head 45°	XG  Caterpillar Flange Head 60°	XN  Caterpillar Flange Head 90°			

ORFS	JC B1b-28  ORFS - short	JS  ORFS - long	J7  ORFS 45°	J9  ORFS Female 90°	J1  ORFS 90° - extra long	J5  ORFS 90° - long	JM  ORFS Male
	JD  Male ORFS - Bulkhead with Locknut (with O-ring)						
JIS	FU  GU	GU  GUO	MU  Female Metric Swivel - (30° Flare)	MZ  Female Metric Swivel - (30° Flare)	UT  Male BSP Taper Pipe Rigid - (60° Cone)		
	French Standard	FG  Male Rigid Gas Series - (24° Cone)	F2  Female Swivel Gas Series	F4  Female Swivel Gas Series - (Ball Nose)	F6  Male Metric (24° Cone)	F9  Swivel Female Metric (Ball Nose)	FA  Metric Male for Agriculture Valves
High Pressure Cleaning		CW  Power Cleaner Connection	PW  Male Kärcher Metric Cleaning Hose Fitting - Rigid	NW  Female Kärcher Metric Cleaning Hose Fitting - (New Design)			

others	XU  Female Metric Swivel - (30° Flare)	XY  Female Metric Swivel - (30° Flare)	DK  Male Metric L - Rigid Bulkhead with Locknut (24° Cone)	DX  Female Metric Swivel (M27x2) O-ring - Light Series	FF B1b-29  Metru-Lok Swivel Female	AF B1b-30  Male BSP Parallel Pipe Rigid - Straight (with O-ring Seal)	NM B1b-31  Male BSP Parallel Pipe - L Series - Rigid Straight - ED-Seal
	YW B1b-32  Male Standpipe - Rigid - Straight - A-Lok	VW121 B1b-33  BSP Swivel Female	82 B1b-35  Push-Lok Union	DP B1b-36  Metric Swivel Female Tee / Male Stud	DR B1b-37  Metric Swivel Female Tee	5C B1b-11  60° Cone Swivel Female	6C B1b-12  60° Cone Swivel Female - 45° Elbow
	7C B1b-13  60° Cone Swivel Female - 90° Elbow	5S  Female Tube O-ring Swivel - Short Pilot	5H  Female Tube O-ring Swivel - 45° Elbow Short Pilot	5T  Female Tube O-ring Swivel 90° Elbow Short Pilot	59PT  Male Tube O-ring Swivel - Long Pilot Charge Port at 180° for R134a	5LPT  Female Tube O-ring Swivel - 90° Elbow Long Pilot Charge Port at 180° for R134a	T1  Male Refrigerant Tube Mender - Straight (with Nut and Ferrule)



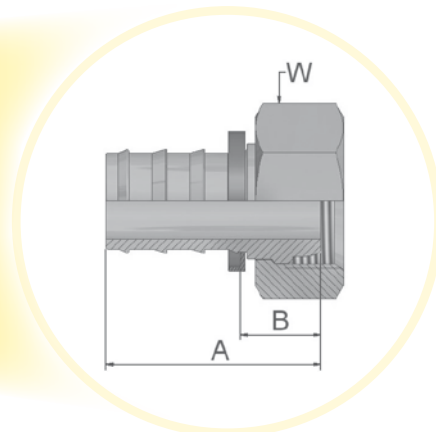
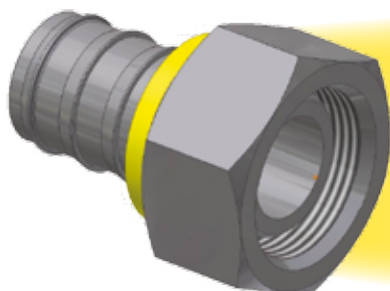

C3 – Female Metric – Light Series – Swivel – Straight (Ball Nose)

DKL



Approved fitting series for hose types:

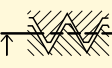

XXXX-XX-XX Part Number 	 Hose I.D.				 Thread metric	Tube O.D. mm	A mm	B mm	 W mm
	DN	Inch	Size	mm					
3C382-6-4	6	1/4	-4	6,3	M12x1,5	6	33	14	14
3C382-6-4B	6	1/4	-4	6,3	M12x1,5	6	33	14	14
3C382-6-4BK	6	1/4	-4	6,3	M12x1,5	6	33	14	14
3C382-6-4C	6	1/4	-4	6,3	M12x1,5	6	35	16	14
3C382-8-4	6	1/4	-4	6,3	M14x1,5	8	33	14	17
3C382-8-4B	6	1/4	-4	6,3	M14x1,5	8	36	16	19
3C382-8-4BK	6	1/4	-4	6,3	M14x1,5	8	36	16	19
3C382-8-4C	6	1/4	-4	6,3	M14x1,5	8	33	14	17
3C382-10-4	6	1/4	-4	6,3	M16x1,5	10	34	14	19
3C382-10-4BK	6	1/4	-4	6,3	M16x1,5	10	34	14	19
3C382-10-4C	6	1/4	-4	6,3	M16x1,5	10	36	17	19
3C382-10-6	10	3/8	-6	9,5	M16x1,5	10	38	15	19
3C382-10-6B	10	3/8	-6	9,5	M16x1,5	10	38	15	19
3C382-10-6BK	10	3/8	-6	9,5	M16x1,5	10	38	15	19
3C382-10-6C	10	3/8	-6	9,5	M16x1,5	10	40	17	19
3C382-12-6	10	3/8	-6	9,5	M18x1,5	12	38	16	22
3C382-12-6BK	10	3/8	-6	9,5	M18x1,5	12	38	16	22
3C382-12-6C	10	3/8	-6	9,5	M18x1,5	12	38	15	22
3C382-15-8	12	1/2	-8	12,7	M22x1,5	15	42	15	27
3C382-15-8B	12	1/2	-8	12,7	M22x1,5	15	42	15	27
3C382-15-8C	12	1/2	-8	12,7	M22x1,5	15	44	17	27
3C382-15-8BK	12	1/2	-8	12,7	M22x1,5	15	46	17	27
3C382-15-10	16	5/8	-10	15,9	M22x1,5	15	56	20	27
3C382-18-10	16	5/8	-10	15,9	M26x1,5	18	53	17	32
3C382-18-10C	16	5/8	-10	15,9	M26x1,5	18	54	17	32
3C382-22-12	20	3/4	-12	19,1	M30x2	22	53	17	36
3C382-22-12B	20	3/4	-12	19,1	M30x2	22	53	17	36
3C382-22-12BK	20	3/4	-12	19,1	M30x2	22	53	17	36
3C382-28-16	25	1	-16	25,4	M36x2	28	58	22	41
3C382-28-16BK	25	1	-16	25,4	M36x2	28	58	22	41
3C382-28-16C-K	25	1	-16	25,4	M36x2	28	58	20	41

Information about standard products or non-standard products can be found in the current price list. Material: steel chromium(VI) free plated; Dimensions shown may be changed at any time without prior notice. B: Brass; C: Stainless Steel; K: Without plastic ring

C4 – Female Metric – Light Series – Swivel – 45° Elbow (Ball Nose)

DKL 45°

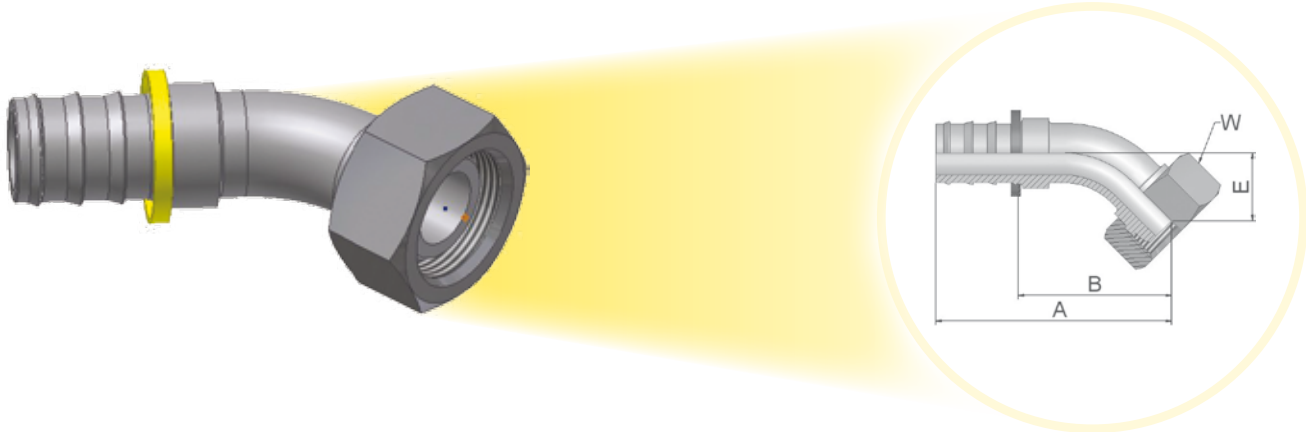

Approved fitting series for hose types:



XXXX·XX·XX Part Number 	Hose I.D.				Thread metric	Tube O.D.	A	B	E	W
	DN	Inch	Size	mm						
3C482-6-4	6	1/4	-4	6,3	M12x1,5	6	51	32	16	14
3C482-6-4B	6	1/4	-4	6,3	M12x1,5	6	51	32	16	14
3C482-8-4	6	1/4	-4	6,3	M14x1,5	8	51	32	16	17
3C482-8-4B	6	1/4	-4	6,3	M14x1,5	8	51	32	16	17
3C482-8-4C	6	1/4	-4	6,3	M14x1,5	8	49	30	14	17
3C482-10-6	10	3/8	-6	9,5	M16x1,5	10	58	35	18	19
3C482-10-6B	10	3/8	-6	9,5	M16x1,5	10	58	35	18	19
3C482-10-6C	10	3/8	-6	9,5	M16x1,5	10	59	36	19	19
3C482-12-6	10	3/8	-6	9,5	M18x1,5	12	59	36	18	22
3C482-12-6B	10	3/8	-6	9,5	M18x1,5	12	59	36	18	22
3C482-15-8	12	1/2	-8	12,7	M22x1,5	15	68	41	19	27
3C482-15-8B	12	1/2	-8	12,7	M22x1,5	15	68	41	19	27
3C482-15-10	16	5/8	-10	15,9	M22x1,5	15	82	45	21	27
3C482-15-10B	16	5/8	-10	15,9	M22x1,5	15	82	45	21	27
3C482-18-10	16	5/8	-10	15,9	M26x1,5	18	81	45	21	32
3C482-18-10B	16	5/8	-10	15,9	M26x1,5	18	81	44	21	32
3C482-18-12	20	3/4	-12	19,1	M26x1,5	18	99	62	31	32
3C482-22-12	20	3/4	-12	19,1	M30x2	22	88	52	23	36
3C482-22-12B	20	3/4	-12	19,1	M30x2	22	88	52	23	36
3C482-28-16-K	25	1	-16	25,4	M36x2	28	105	67	30	41

Material: steel chromium(VI) free plated
B: Brass
C: Stainless Steel
K: Without plastic ring

Information about standard products or non-standard products can be found in the current price list.
Dimensions shown may be changed at any time without prior notice.



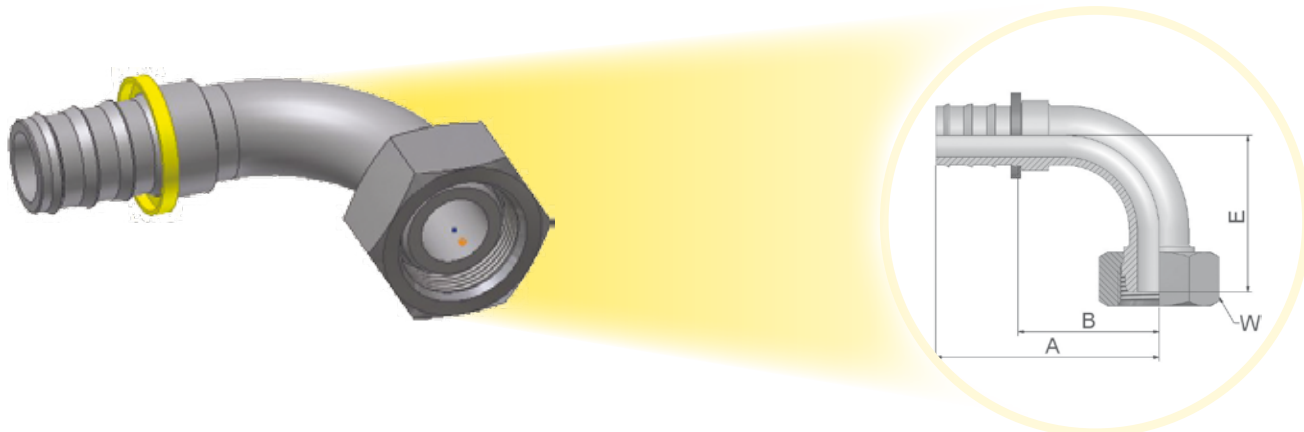

C5 – Female Metric – Light Series – Swivel – 90° Elbow (Ball Nose)

DKL 90°

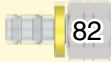

Approved fitting series for hose types:

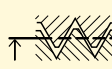

XXXX.XX.XX Part Number 	 Hose I.D.				 Thread metric	Tube O.D. mm	A mm	B mm	E mm	 W mm
	DN	Inch	Size	mm						
3C582-6-4	6	1/4	-4	6,3	M12x1,5	6	42	23	29	14
3C582-6-4B	6	1/4	-4	6,3	M12x1,5	6	42	23	29	14
3C582-8-4	6	1/4	-4	6,3	M14x1,5	8	42	23	29	17
3C582-8-4B	6	1/4	-4	6,3	M14x1,5	8	42	23	29	17
3C582-10-4	6	1/4	-4	6,3	M16x1,5	10	42	23	29	19
3C582-10-4C	6	1/4	-4	6,3	M16x1,5	10	43	23	31	19
3C582-10-6	10	3/8	-6	9,5	M16x1,5	10	49	27	33	19
3C582-10-6B	10	3/8	-6	9,5	M16x1,5	10	49	27	33	19
3C582-10-6C	10	3/8	-6	9,5	M16x1,5	10	49	27	33	19
3C582-12-6	10	3/8	-6	9,5	M18x1,5	12	49	27	34	22
3C582-12-6B	10	3/8	-6	9,5	M18x1,5	12	49	27	34	22
3C582-12-6C	10	3/8	-6	9,5	M18x1,5	12	49	27	34	22
3C582-15-8	12	1/2	-8	12,7	M22x1,5	15	60	34	39	27
3C582-15-8B	12	1/2	-8	12,7	M22x1,5	15	60	34	39	27
3C582-15-8C	12	1/2	-8	12,7	M22x1,5	15	60	34	39	27
3C582-18-10	16	5/8	-10	15,9	M26x1,5	18	74	37	43	32
3C582-22-12	20	3/4	-12	19,1	M30x2	22	88	51	50	36
3C582-22-12B	20	3/4	-12	19,1	M30x2	22	88	51	50	36
3C582-22-12C	20	3/4	-12	19,1	M30x2	22	88	51	54	36
3C582-28-16-K	25	1	-16	25,4	M36x2	28	99	61	70	41

Material: steel chromium(VI) free plated
 B: Brass
 C: Stainless Steel
 K: Without plastic ring



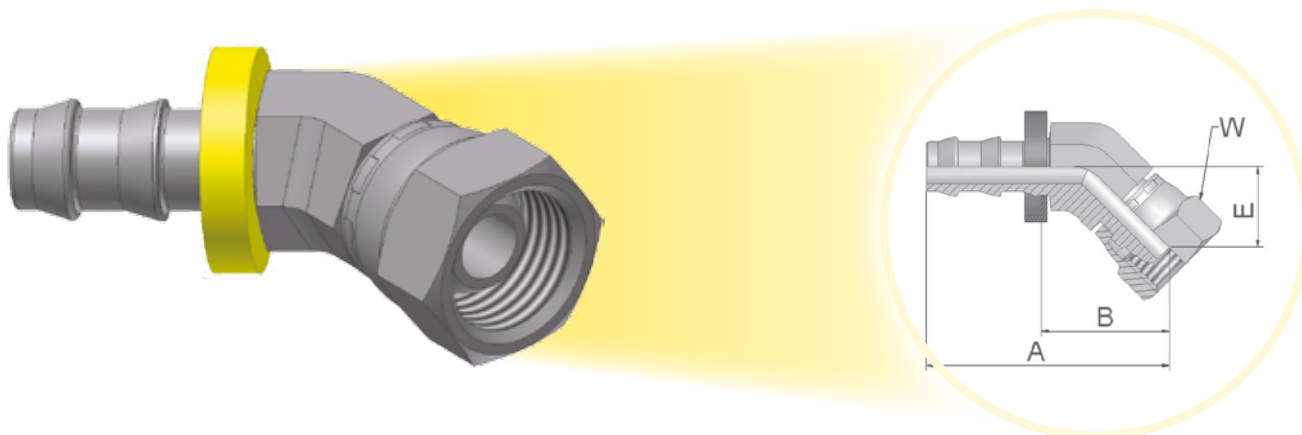

Information about standard products or non-standard products can be found in the current price list.
 Dimensions shown may be changed at any time without prior notice.

9B – Metric – Swivel Female 45° Elbow – Light Series



Approved fitting series for hose types:

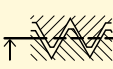

XXXX.XX.XX Part Number 	 Hose I.D.				 Thread metric	Tube O.D. mm	A mm	B mm	E mm	 W mm
	DN	Inch	Size	mm						
39B82-6-4BK	6	1/4	-4	6,3	M12x1,5	6	44	23	16	14
39B82-8-4BK	6	1/4	-4	6,3	M14x1,5	8	43	23	15	19
39B82-10-6BK	10	3/8	-6	9,5	M16x1,5	10	48	25	16	19
39B82-12-6BK	10	3/8	-6	9,5	M18x1,5	12	50	26	17	22
39B82-15-8BK	12	1/2	-8	12,7	M22x1,5	15	54	26	18	27

B: Brass
K: Without plastic ring



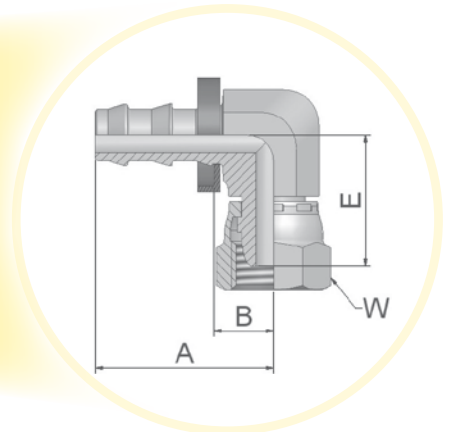
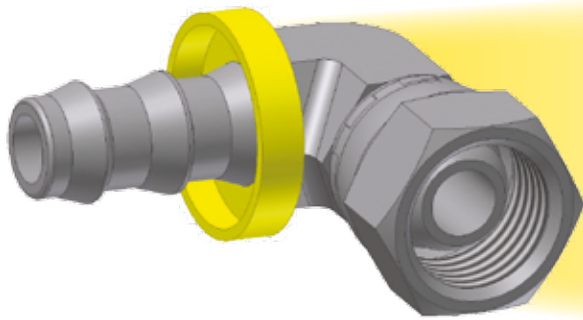

Information about standard products or non-standard products can be found in the current price list. Dimensions shown may be changed at any time without prior notice.

9C – Light Series Metric Swivel Female 90° Elbow

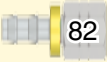

Approved fitting series for hose types:

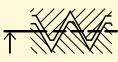

XXXX-XX-XX Part Number 	 Hose I.D.				 Thread metric	Tube O.D.	A	B	E	 W
	DN	Inch	Size	mm						
39C82-6-4BK	6	1/4	-4	6,3	M12x1,5	6	30	10	22	14
39C82-8-4BK	6	1/4	-4	6,3	M14x1,5	8	30	10	22	19
39C82-10-6BK	10	3/8	-6	9,5	M16x1,5	10	34	10	25	19
39C82-12-6BK	10	3/8	-6	9,5	M18x1,5	12	34	10	25	22
39C82-15-8BK	12	1/2	-8	12,7	M22x1,5	15	43	15	32	27

B: Brass
K: Without plastic ring

Information about standard products or non-standard products can be found in the current price list. Dimensions shown may be changed at any time without prior notice.



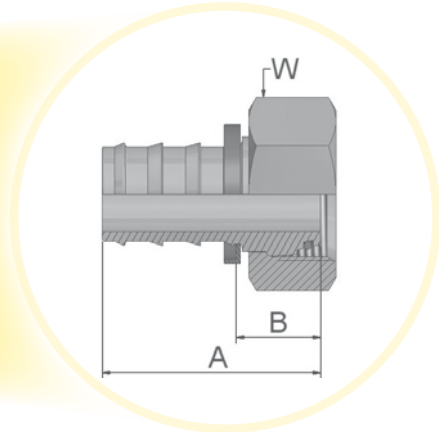
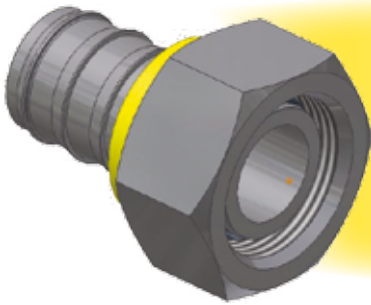

CA – Female Metric 24° – Light Series with O-ring – Swivel – Straight

ISO 12151-2-SWS-L – DKOL

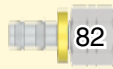

Approved fitting series for hose types:

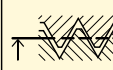

XXXX·XX·XX Part Number 	 Hose I.D.				 Thread metric	Tube O.D.	A	B	 W
	DN	Inch	Size	mm					
3CA82-6-4	6	1/4	-4	6,3	M12x1,5	6	40	21	14
3CA82-6-4B	6	1/4	-4	6,3	M12x1,5	6	40	21	14
3CA82-8-4	6	1/4	-4	6,3	M14x1,5	8	36	17	17
3CA82-8-4B	6	1/4	-4	6,3	M14x1,5	8	36	17	17
3CA82-10-4	6	1/4	-4	6,3	M16x1,5	10	36	17	19
3CA82-10-6	10	3/8	-6	9,5	M16x1,5	10	40	17	19
3CA82-10-6B	10	3/8	-6	9,5	M16x1,5	10	40	17	19
3CA82-12-6	10	3/8	-6	9,5	M18x1,5	12	40	17	22
3CA82-12-6B	10	3/8	-6	9,5	M18x1,5	12	40	17	22
3CA82-15-8	12	1/2	-8	12,7	M22x1,5	15	44	18	27
3CA82-15-8B	12	1/2	-8	12,7	M22x1,5	15	44	18	27
3CA82-15-10	16	5/8	-10	15,9	M22x1,5	15	60	23	27
3CA82-15-10B	16	5/8	-10	15,9	M22x1,5	15	60	23	27
3CA82-18-10	16	5/8	-10	15,9	M26x1,5	18	56	19	32
3CA82-22-12	20	3/4	-12	19,1	M30x2	22	58	21	36
3CA82-22-12B	20	3/4	-12	19,1	M30x2	22	58	21	36

Material: steel chromium(VI) free plated

B: Brass

Fittings with standard O-ring seals can be used for temperatures from -30 °C up to +105 °C.

Information about standard products or non-standard products can be found in the current price list. Dimensions shown may be changed at any time without prior notice.



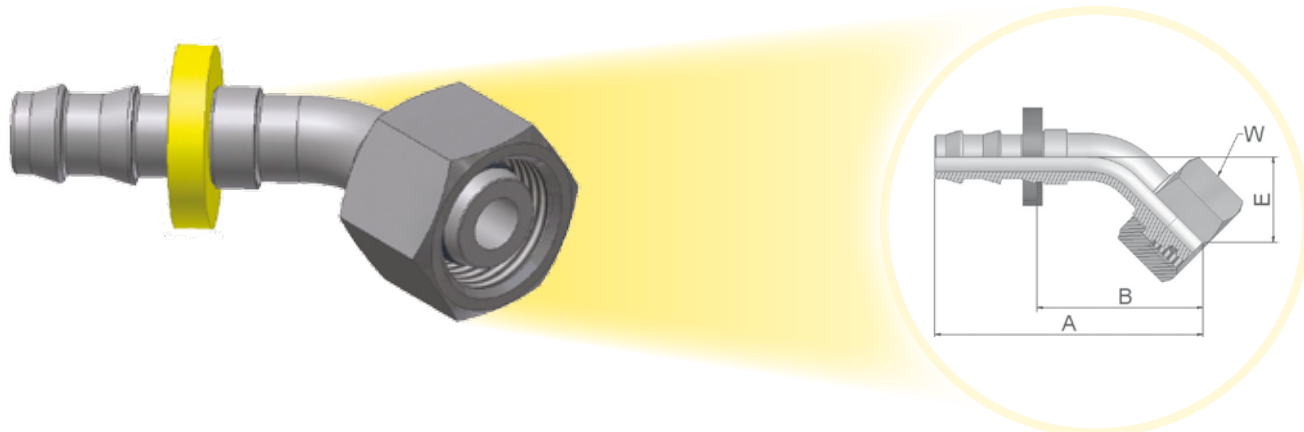

CE – Female Metric 24° – Light Series with O-ring – Swivel – 45° Elbow

ISO 12151-2-SWE45-L – DKOL 45°

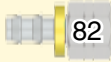

Approved fitting series for hose types:

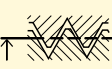

XXXX-XX-XX Part Number 	 Hose I.D.				 Thread metric	Tube O.D.	A	B	E	 W
	DN	Inch	Size	mm						
3CE82-6-4	6	1/4	-4	6,3	M12x1,5	6	56	37	21	14
3CE82-8-4	6	1/4	-4	6,3	M14x1,5	8	51	31	16	17
3CE82-10-6	10	3/8	-6	9,5	M16x1,5	10	59	37	19	19
3CE82-12-6	10	3/8	-6	9,5	M18x1,5	12	60	37	19	22
3CE82-15-8	12	1/2	-8	12,7	M22x1,5	15	69	43	21	27
3CE82-18-10	16	5/8	-10	15,9	M26x1,5	18	83	46	23	32
3CE82-22-12	20	3/4	-12	19,1	M30x2	22	97	60	26	36

Material: steel chromium(VI) free plated
 Fittings with standard O-ring seals can be used for temperatures from -30 °C up to +105 °C.

Information about standard products or non-standard products can be found in the current price list.
 Dimensions shown may be changed at any time without prior notice.

CF – Female Metric 24° – Light Series with O-ring – Swivel – 90° Elbow

ISO 12151-2-SWE-L – DKOL 90°

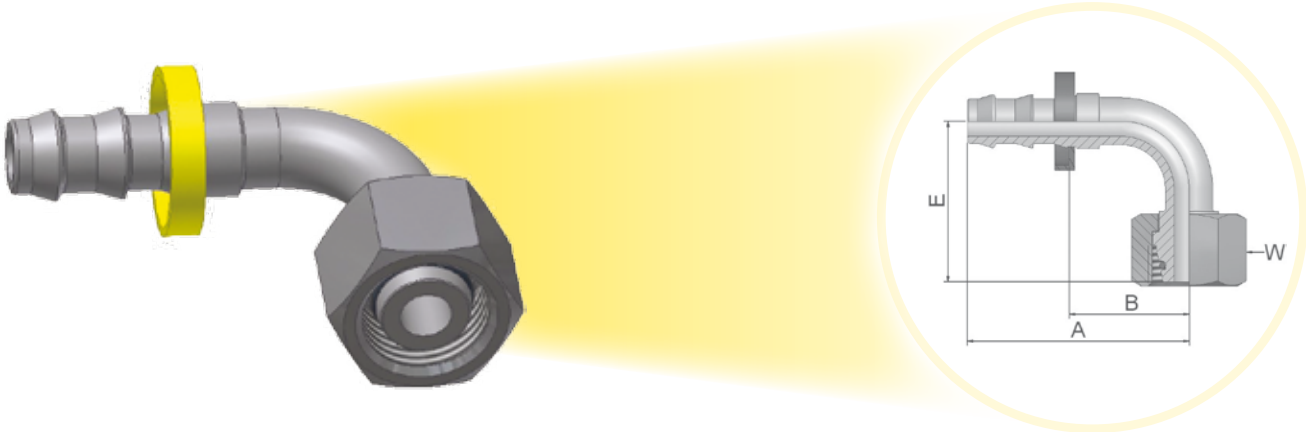

Approved fitting series for hose types:

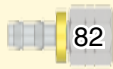

XXXX·XX·XX Part Number 	Hose I.D.				Thread metric	Tube O.D.	A	B	E	W
	DN	Inch	Size	mm						
3CF82-6-4	6	1/4	-4	6,3	M12x1,5	6	42	23	36	14
3CF82-8-4	6	1/4	-4	6,3	M14x1,5	8	42	23	32	17
3CF82-10-4	6	1/4	-4	6,3	M16x1,5	10	42	23	31	19
3CF82-10-6	10	3/8	-6	9,5	M16x1,5	10	49	27	35	19
3CF82-10-6B	10	3/8	-6	9,5	M16x1,5	10	49	27	35	19
3CF82-12-6	10	3/8	-6	9,5	M18x1,5	12	49	27	36	22
3CF82-12-6B	10	3/8	-6	9,5	M18x1,5	12	49	27	36	22
3CF82-15-8	12	1/2	-8	12,7	M22x1,5	15	58	32	41	27
3CF82-18-10	16	5/8	-10	15,9	M26x1,5	18	74	37	45	32
3CF82-22-12	20	3/4	-12	19,1	M30x2	22	88	51	55	36

Material: steel chromium(VI) free plated
 B & BK parts have brass nipples and steel nuts.
 Fittings with standard O-ring seals can be used for temperatures from -30 °C up to +105 °C.
 Special O-rings are available on request.

Information about standard products or non-standard products can be found in the current price list.
 Dimensions shown may be changed at any time without prior notice.



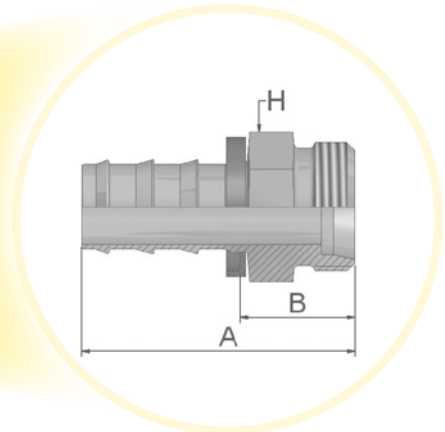
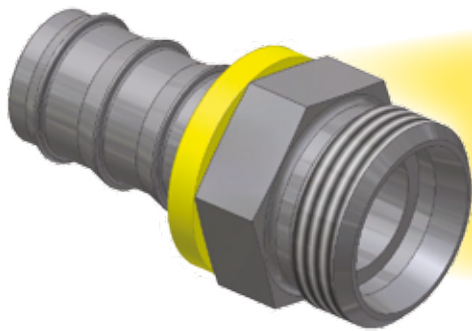

DO – Male Metric 24° – Light Series – Rigid – Straight

ISO 12151-2-S-L – CEL



Approved fitting series for hose types:

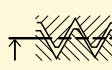

XXXX.XX.XX Part Number 	 Hose I.D.				 Thread metric	Tube O.D.	A	B	 H
	DN	Inch	Size	mm					
3D082-6-4	6	1/4	-4	6,3	M12x1,5	6	35	16	12
3D082-8-4	6	1/4	-4	6,3	M14x1,5	8	36	17	14
3D082-10-6	10	3/8	-6	9,5	M16x1,5	10	41	18	17
3D082-10-6B	10	3/8	-6	9,5	M16x1,5	10	41	18	17
3D082-10-6C	10	3/8	-6	9,5	M16x1,5	10	41	18	17
3D082-12-6	10	3/8	-6	9,5	M18x1,5	12	41	18	19
3D082-12-6B	10	3/8	-6	9,5	M18x1,5	12	41	18	19
3D082-12-6C	10	3/8	-6	9,5	M18x1,5	12	41	18	19
3D082-15-8	12	1/2	-8	12,7	M22x1,5	15	49	23	22
3D082-15-8B	12	1/2	-8	12,7	M22x1,5	15	49	23	22
3D082-15-8BK	12	1/2	-8	12,7	M22x1,5	15	49	22	22
3D082-15-8C	12	1/2	-8	12,7	M22x1,5	15	49	22	22
3D082-18-8	12	1/2	-8	12,7	M26x1,5	18	48	21	27
3D082-18-10	16	5/8	-10	15,9	M26x1,5	18	58	21	27
3D082-22-12	20	3/4	-12	19,1	M30x2	22	63	27	30
3D082-22-12B	20	3/4	-12	19,1	M30x2	22	63	27	30

Material: steel chromium(VI) free plated
 B: Brass
 C: Stainless Steel
 K: Without plastic ring

Information about standard products or non-standard products can be found in the current price list.
 Dimensions shown may be changed at any time without prior notice.

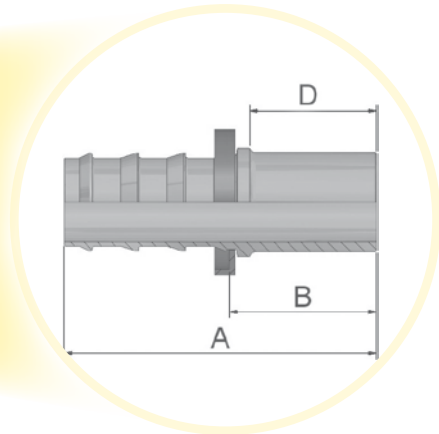
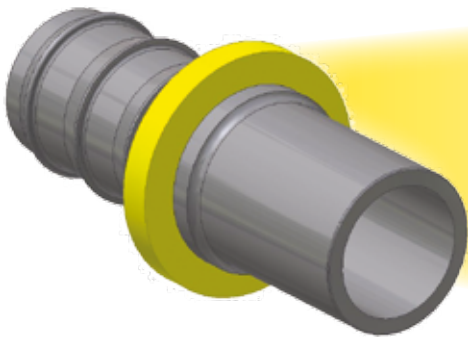

1D – Metric Standpipe – Light Series – Rigid – Straight

ISO 8434-1 – BEL



Approved fitting series for hose types:

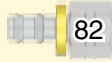

XXXX·XX·XX Part Number 	 Hose I.D.				Tube O.D. mm	A mm	B mm	D mm
	DN	Inch	Size	mm				
31D82-6-4	6	1/4	-4	6,3	6	44	25	22
31D82-6-4B	6	1/4	-4	6,3	6	44	25	22
31D82-8-4	6	1/4	-4	6,3	8	44	25	22
31D82-8-4B	6	1/4	-4	6,3	8	44	25	22
31D82-10-6	10	3/8	-6	9,5	10	49	26	23
31D82-10-6B	10	3/8	-6	9,5	10	49	26	23
31D82-10-6C	10	3/8	-6	9,5	10	49	26	23
31D82-12-6	10	3/8	-6	9,5	12	49	27	23
31D82-12-6B	10	3/8	-6	9,5	12	49	27	23
31D82-12-6C	10	3/8	-6	9,5	12	49	27	23
31D82-15-8	12	1/2	-8	12,7	15	55	29	25
31D82-15-8B	12	1/2	-8	12,7	15	55	29	25
31D82-15-8C	12	1/2	-8	12,7	15	55	29	25
31D82-18-10	16	5/8	-10	15,9	18	67	30	26
31D82-18-10B	16	5/8	-10	15,9	18	67	30	26
31D82-22-12	20	3/4	-12	19,1	22	69	32	28
31D82-22-12B	20	3/4	-12	19,1	22	69	32	28

Attention: For assembly of nut and sleeve use pre-assembly body.

Material: steel chromium(VI) free plated

B: Brass

C: Material: Stainless Steel





Information about standard products or non-standard products can be found in the current price list.
Dimensions shown may be changed at any time without prior notice.

5C – 60° Cone Swivel Female

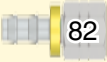

Approved fitting series for hose types:

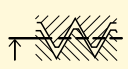

XXXX.XX.XX Part Number 	 Hose I.D.				 Thread metric	A	B	 W
	DN	Inch	Size	mm				
35C82-12x1-4BK	6	1/4	-4	6,3	M12x1	33	13	14
35C82-6-4BK	6	1/4	-4	6,3	M12x1,5	33	14	14
35C82-10-6BK	10	3/8	-6	9,5	M16x1,5	38	15	19
35C82-10-6B	10	3/8	-6	9,5	M16x1,5	38	15	19
35C82-15-8BK	12	1/2	-8	12,7	M22x1,5	44	18	27
35C82-15-8B	12	1/2	-8	12,7	M22x1,5	44	18	27
35C82-18-10BK	16	5/8	-10	15,9	M26x1,5	56	18	32

B: Brass
K: Without plastic ring

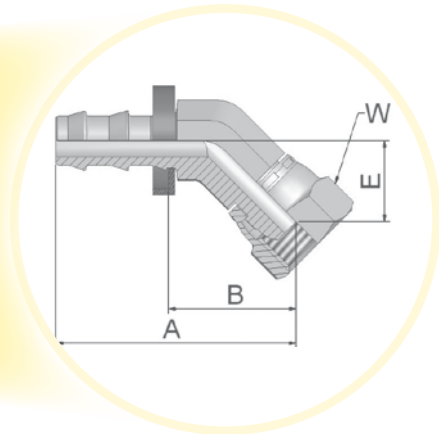
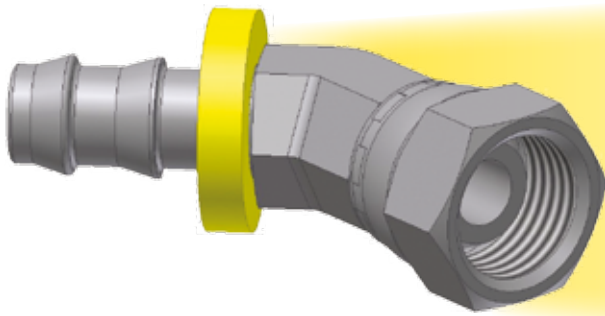

Information about standard products or non-standard products can be found in the current price list.
Dimensions shown may be changed at any time without prior notice.

6C – 60° Cone Swivel Female – 45° Elbow



Approved fitting series for hose types:

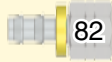

XXXX·XX·XX Part Number 	 Hose I.D.				Thread metric	A mm	B mm	E mm	 W mm
	DN	Inch	Size	mm					
36C82-12x1-4BK	6	1/4	-4	6,3	M12x1	43	22	15	14
36C82-6-4BK	6	1/4	-4	6,3	M12x1,5	44	25	16	14
36C82-6-4B	6	1/4	-4	6,3	M12x1,5	44	25	16	14
36C82-10-6BK	10	3/8	-6	9,5	M16x1,5	48	26	16	19
36C82-10-6B	10	3/8	-6	9,5	M16x1,5	48	26	16	19
36C82-15-8BK	12	1/2	-8	12,7	M22x1,5	54	28	18	27

B: Brass
K: Without plastic ring



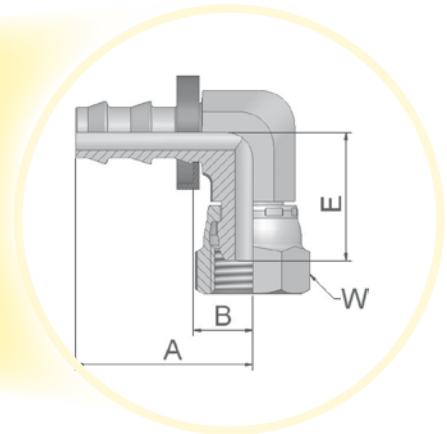
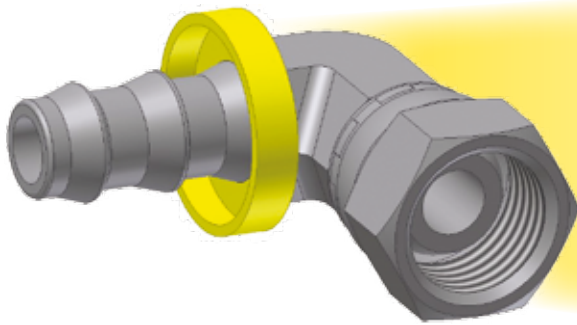

Information about standard products or non-standard products can be found in the current price list.
Dimensions shown may be changed at any time without prior notice.

7C – 60° Cone Swivel Female – 90° Elbow

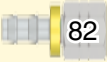

Approved fitting series for hose types:

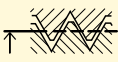

XXXX.XX.XX Part Number 	 Hose I.D.				 Thread metric	A	B	E	 W
	DN	Inch	Size	mm					
37C82-12x1-4BK	6	1/4	-4	6,3	M12x1	30	10	22	14
37C82-12x1-4B	6	1/4	-4	6,3	M12x1	30	10	22	14
37C82-6-4BK	6	1/4	-4	6,3	M12x1,5	30	11	22	14
37C82-6-4B	6	1/4	-4	6,3	M12x1,5	30	11	22	14
37C82-10-6BK	10	3/8	-6	9,5	M16x1,5	34	11	25	19
37C82-10-6B	10	3/8	-6	9,5	M16x1,5	34	11	25	19
37C82-15-8BK	12	1/2	-8	12,7	M22x1,5	43	16	32	27
37C82-15-8B	12	1/2	-8	12,7	M22x1,5	43	16	32	27

B: Brass
K: Without plastic ring

Information about standard products or non-standard products can be found in the current price list.
Dimensions shown may be changed at any time without prior notice.





92 – Female BSP Parallel Pipe – Swivel – Straight (60° Cone)

BS5200-A – DKR

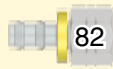

Approved fitting series for hose types:

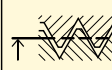

XXXX·XX·XX Part Number 	 Hose I.D.				 Thread BSP	A mm	B mm	 W mm
	DN	Inch	Size	mm				
39282-4-4	6	1/4	-4	6,3	1/4x19	33	14	17
39282-4-4B	6	1/4	-4	6,3	1/4x19	33	14	17
39282-4-4C	6	1/4	-4	6,3	1/4x19	33	14	19
39282-6-4B	6	1/4	-4	6,3	3/8x19	37	18	22
39282-6-6	10	3/8	-6	9,5	3/8x19	37	14	19
39282-6-6B	10	3/8	-6	9,5	3/8x19	37	14	19
39282-6-6C	10	3/8	-6	9,5	3/8x19	40	17	22
39282-8-8	12	1/2	-8	12,7	1/2x14	42	15	27
39282-8-8B	12	1/2	-8	12,7	1/2x14	42	15	27
39282-8-8C	12	1/2	-8	12,7	1/2x14	43	16	27
39282-10-10	16	5/8	-10	15,9	5/8x14	53	16	30
39282-10-10B	16	5/8	-10	15,9	5/8x14	55	18	30
39282-12-10C	16	5/8	-10	15,9	3/4x14	55	18	32
39282-12-12	20	3/4	-12	19,1	3/4x14	58	21	32
39282-12-12B	20	3/4	-12	19,1	3/4x14	58	21	32
39282-16-16	25	1	-16	25,4	1x11	57	20	41

Material: steel chromium(VI) free plated

B: Brass

C: Material: Stainless Steel

Information about standard products or non-standard products can be found in the current price list.
Dimensions shown may be changed at any time without prior notice.



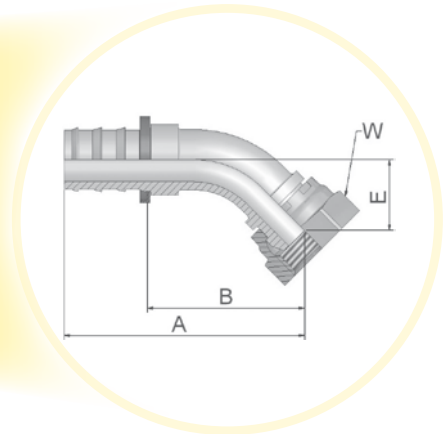
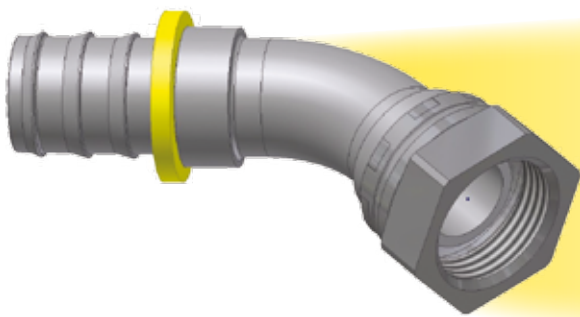

B1 – Female BSP Parallel Pipe – Swivel – 45° Elbow (60° Cone)

BS 5200-D – DKR 45°



Approved fitting series for hose types:

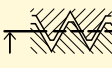

 Part Number 	 Hose I.D.				 Thread BSP	A	B	E	 W
	DN	Inch	Size	mm					
3B182-4-4	6	1/4	-4	6,3	1/4x19	51	32	16	17
3B182-6-6	10	3/8	-6	9,5	3/8x19	58	35	18	19
3B182-6-6B	10	3/8	-6	9,5	3/8x19	69	46	17	19
3B182-8-8	12	1/2	-8	12,7	1/2x14	68	41	19	27
3B182-8-8B	12	1/2	-8	12,7	1/2x14	68	41	19	27
3B182-10-10	16	5/8	-10	15,9	5/8x14	81	45	21	30
3B182-12-12	20	3/4	-12	19,1	3/4x14	92	55	27	32
3B182-16-16-K	25	1	-16	25,4	1x11	106	68	31	41

Material: steel chromium(VI) free plated
 B: Brass
 K: Without plastic ring

Information about standard products or non-standard products can be found in the current price list.
 Dimensions shown may be changed at any time without prior notice.



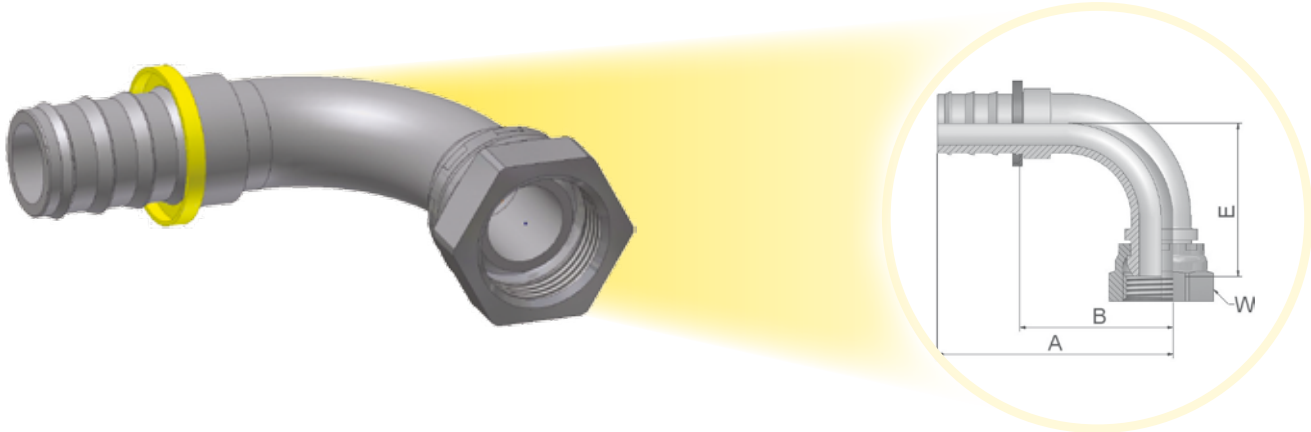

B2 – Female BSP Parallel Pipe – Swivel – 90° Elbow (60° Cone)

BS 5200-B – DKR 90°

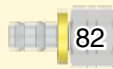

Approved fitting series for hose types:

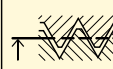

XXXX·XX·XX Part Number 	 Hose I.D.				 Thread BSP	A	B	E	 W
	DN	Inch	Size	mm					
3B282-4-4	6	1/4	-4	6,3	1/4x19	42	23	29	17
3B282-4-4B	6	1/4	-4	6,3	1/4x19	42	23	29	17
3B282-6-6	10	3/8	-6	9,5	3/8x19	49	27	33	19
3B282-6-6B	10	3/8	-6	9,5	3/8x19	49	27	33	19
3B282-8-8	12	1/2	-8	12,7	1/2x14	60	34	39	27
3B282-8-8B	12	1/2	-8	12,7	1/2x14	60	34	39	27
3B282-10-8	12	1/2	-8	12,7	5/8x14	58	32	40	30
3B282-10-10	16	5/8	-10	15,9	5/8x14	74	37	43	30
3B282-10-10B	16	5/8	-10	15,9	5/8x14	74	37	44	30
3B282-12-12	20	3/4	-12	19,1	3/4x14	88	51	53	32
3B282-12-12B	20	3/4	-12	19,1	3/4x14	88	51	53	32
3B282-16-16-K	25	1	-16	25,4	1x11	99	61	68	41

Material: steel chromium(VI) free plated
B: Nipple: Brass, Nut: Steel
K: Without plastic ring

Information about standard products or non-standard products can be found in the current price list.
Dimensions shown may be changed at any time without prior notice.



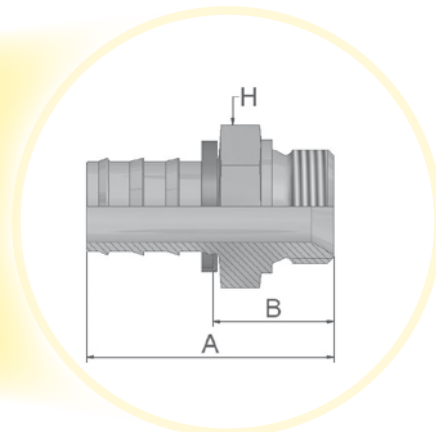
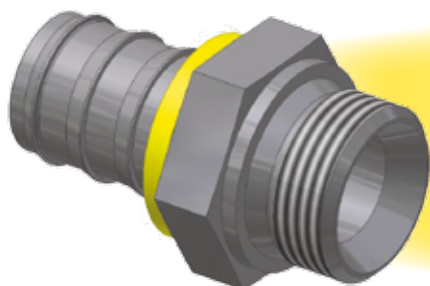

D9 – Male BSP Parallel Pipe – Rigid – Straight (60° Cone)

BS5200 – AGR

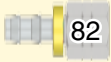

Approved fitting series for hose types:

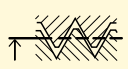

XXXX.XX.XX Part Number 	 Hose I.D.				 Thread BSP	A mm	B mm	 H mm
	DN	Inch	Size	mm				
3D982-2-4	6	1/4	-4	6,3	1/8x28	36	17	14
3D982-4-4	6	1/4	-4	6,3	1/4x19	41	23	19
3D982-4-4B	6	1/4	-4	6,3	1/4x19	41	23	19
3D982-4-6	10	3/8	-6	9,5	1/4x19	44	21	19
3D982-4-6B	10	3/8	-6	9,5	1/4x19	44	21	19
3D982-6-6	10	3/8	-6	9,5	3/8x19	45	23	22
3D982-6-6B	10	3/8	-6	9,5	3/8x19	45	23	22
3D982-8-8	12	1/2	-8	12,7	1/2x14	53	27	27
3D982-8-8B	12	1/2	-8	12,7	1/2x14	53	27	27
3D982-10-10	16	5/8	-10	15,9	5/8x14	65	28	30
3D982-10-10B	16	5/8	-10	15,9	5/8x14	65	28	30
3D982-12-12	20	3/4	-12	19,1	3/4x14	65	28	32
3D982-12-12B	20	3/4	-12	19,1	3/4x14	65	28	32

Material: steel chromium(VI) free plated
B: Brass

Information about standard products or non-standard products can be found in the current price list.
Dimensions shown may be changed at any time without prior notice.



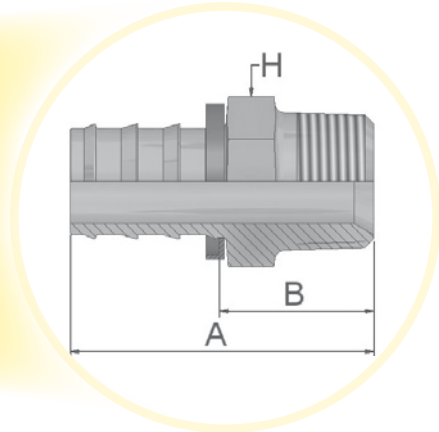
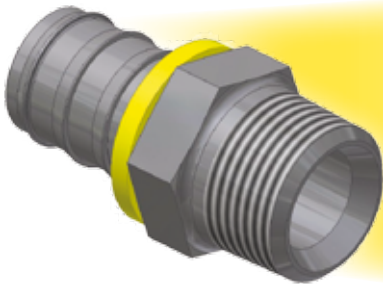

91 – Male BSP Taper Pipe – Rigid – Straight

BS5200 – AGR-K

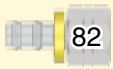

Approved fitting series for hose types:

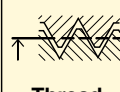

XXXX·XX·XX Part Number 	 Hose I.D.				 Thread BSP	A mm	B mm	 H mm
	DN	Inch	Size	mm				
39182-2-4B	6	1/4	-4	6,3	1/8x28	37	18	12
39182-2-4	6	1/4	-4	6,3	1/8x28	37	18	12
39182-4-4	6	1/4	-4	6,3	1/4x19	40	21	14
39182-4-4B	6	1/4	-4	6,3	1/4x19	40	21	14
39182-4-6	10	3/8	-6	9,5	1/4x19	44	21	14
39182-4-6B	10	3/8	-6	9,5	1/4x19	44	21	14
39182-6-6	10	3/8	-6	9,5	3/8x19	45	22	19
39182-6-6B	10	3/8	-6	9,5	3/8x19	45	22	19
39182-6-8B	12	1/2	-8	12,7	3/8x19	49	22	19
39182-8-8	12	1/2	-8	12,7	1/2x14	55	29	22
39182-8-8B	12	1/2	-8	12,7	1/2x14	55	29	22
39182-8-10B	16	5/8	-10	15,9	1/2x14	65	28	22
39182-12-10B	16	5/8	-10	15,9	3/4x14	68	31	27
39182-12-12	20	3/4	-12	19,1	3/4x14	68	31	27
39182-12-12B	20	3/4	-12	19,1	3/4x14	68	31	27
39182-16-16B	25	1	-16	25,4	1x11	74	38	36

Material: steel chromium(VI) free plated
B: Brass

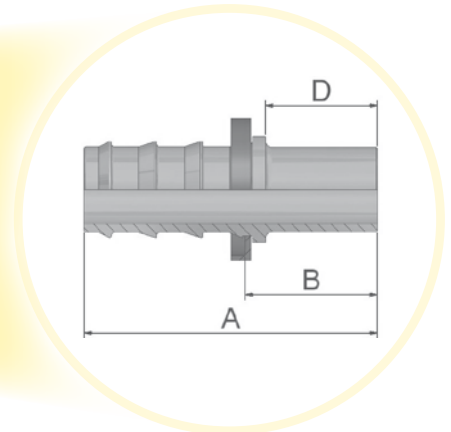
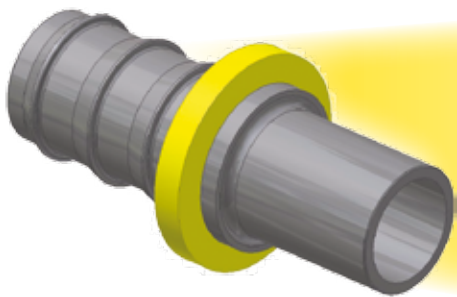

Information about standard products or non-standard products can be found in the current price list.
Dimensions shown may be changed at any time without prior notice.

34 - Inch Standpipe (Brass)



Approved fitting series for hose types:

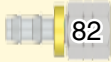

XXXX.XX.XX Part Number 	 Hose I.D.				Tube O.D.	A	B	D
	DN	Inch	Size	mm				
33482-4-4B	6	1/4	-4	6,3	1/4	48	29	26
33482-6-6B	10	3/8	-6	9,5	3/8	57	34	31
33482-8-8B	12	1/2	-8	12,7	1/2	55	28	25
33482-10-10B	16	5/8	-10	15,9	5/8	67	30	25
33482-12-12B	20	3/4	-12	19,1	3/4	67	30	25

B: Brass

Information about standard products or non-standard products can be found in the current price list.
Dimensions shown may be changed at any time without prior notice.

01 – Male NPTF Pipe – Rigid – Straight

SAE J476A – J516 – AGN

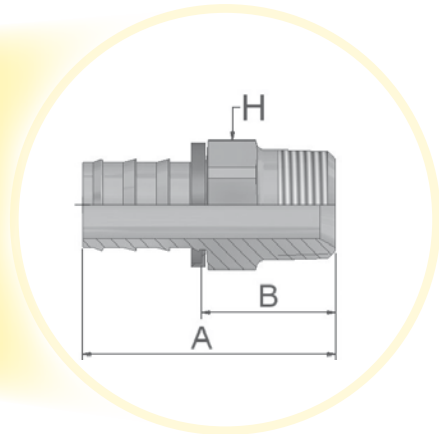
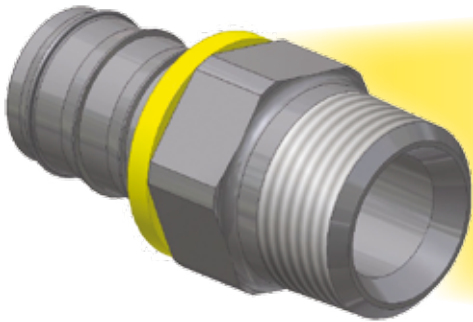

Approved fitting series for hose types:

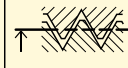

XXXX-XX-XX Part Number 	 Hose I.D.				 Thread NPTF	A	B	H
	DN	Inch	Size	mm		mm	mm	Inch
30182-2-4	6	1/4	-4	6,3	1/8x27	35	16	7/16
30182-2-4B	6	1/4	-4	6,3	1/8x27	35	16	7/16
30182-2-4-SM	6	1/4	-4	6,3	1/8x27	35	16	12
30182-4-4	6	1/4	-4	6,3	1/4x18	40	21	9/16
30182-4-4-SM	6	1/4	-4	6,3	1/4x18	40	21	14
30182-4-4B	6	1/4	-4	6,3	1/4x18	40	21	9/16
30182-4-4C	6	1/4	-4	6,3	1/4x18	40	21	9/16
30182-8-4C	6	1/4	-4	6,3	1/2x14	48	29	7/8
30182-4-6	10	3/8	-6	9,5	1/4x18	45	22	9/16
30182-4-6B	10	3/8	-6	9,5	1/4x18	45	22	9/16
30182-4-6-SM	10	3/8	-6	9,5	1/4x18	45	22	14
30182-6-6	10	3/8	-6	9,5	3/8x18	45	22	11/16
30182-6-6B	10	3/8	-6	9,5	3/8x18	45	22	11/16
30182-6-6-SM	10	3/8	-6	9,5	3/8x18	45	22	22
30182-6-6C	10	3/8	-6	9,5	3/8x18	45	23	11/16
30182-8-6-SM	10	3/8	-6	9,5	1/2x14	52	29	22
30182-8-6B-SM	10	3/8	-6	9,5	1/2x14	52	29	22
30182-6-8	12	1/2	-8	12,7	3/8x18	49	22	11/16
30182-6-8B	12	1/2	-8	12,7	3/8x18	49	22	11/16
30182-8-8	12	1/2	-8	12,7	1/2x14	55	29	7/8
30182-8-8B	12	1/2	-8	12,7	1/2x14	55	29	7/8
30182-8-8B-SM	12	1/2	-8	12,7	1/2x14	55	29	22
30182-8-8C	12	1/2	-8	12,7	1/2x14	55	29	7/8
30182-8-10-SM	16	5/8	-10	15,9	1/2x14	66	29	22
30182-8-10B	16	5/8	-10	15,9	1/2x14	66	29	7/8
30182-8-12-SM	20	3/4	-12	19,1	1/2x14	66	29	22
30182-8-12B	20	3/4	-12	19,1	1/2x14	66	29	7/8
30182-12-12	20	3/4	-12	19,1	3/4x14	66	29	1-1/16
30182-12-12C	20	3/4	-12	19,1	3/4x14	66	29	1-1/16
30182-12-12B	20	3/4	-12	19,1	3/4x14	66	29	1-1/16

Material: steel
chromium(VI)
free plated
B: Brass
C:
Stainless Steel
SM:
Metric Hexagon

Information about standard products or non-standard products can be found in the current price list.
Dimensions shown may be changed at any time without prior notice.

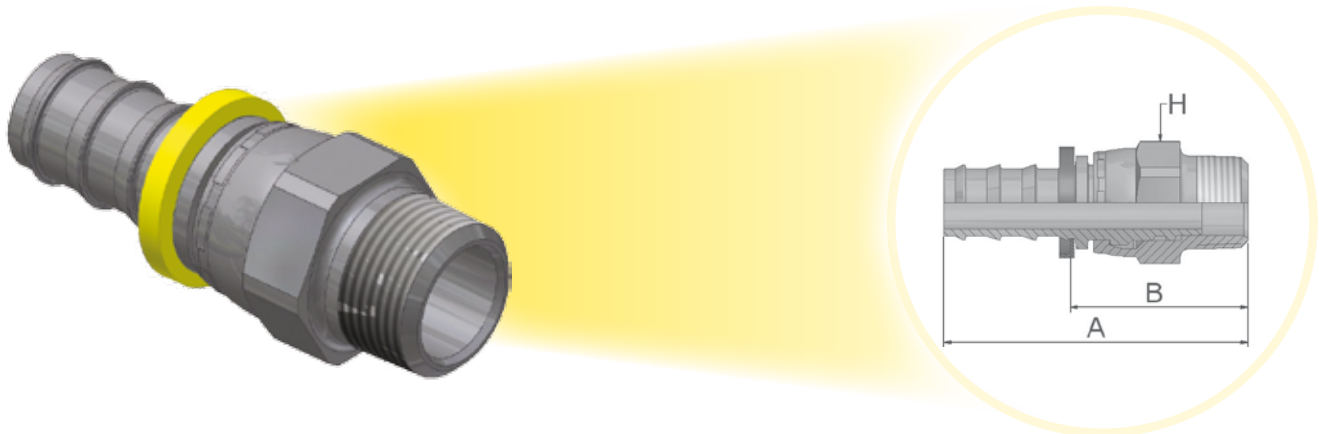

13 – Male NPTF Pipe Swivel

SAE J476A – J516



Approved fitting series for hose types:

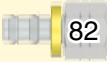

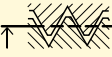
XXXX.XX.XX Part Number 	 Hose I.D.				 Thread NPTF	A	B	H
	DN	Inch	Size	mm				
31382-4-4	6	1/4	-4	6,3	1/4x18	41	22	9/16
31382-4-6	10	3/8	-6	9,5	1/4x18	45	23	11/16
31382-6-6	10	3/8	-6	9,5	3/8x18	45	23	11/16
31382-8-8	12	1/2	-8	12,7	1/2x14	56	29	7/8
31382-12-12	20	3/4	-12	19,1	3/4x14	94	58	1-1/4

Material: steel chromium(VI) free plated

Note: This fitting allows for minor movement under pressure to relieve the torsion on hose, but it is not to be used for continuous or extreme swiveling.

Note: Internal O-ring is not compatible with phosphate ester fluids.

Information about standard products or non-standard products can be found in the current price list. Dimensions shown may be changed at any time without prior notice.

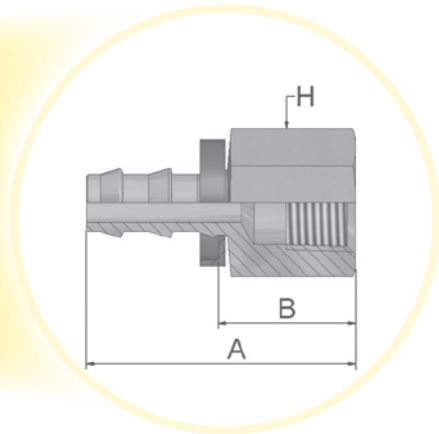
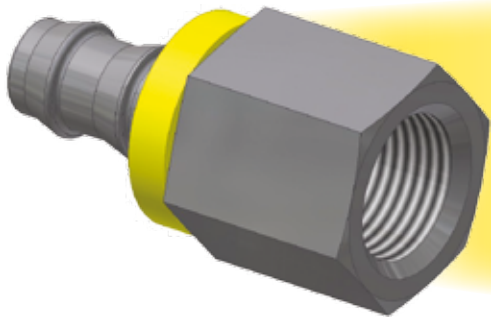

02 – Female NPTF Pipe – Rigid – Straight

SAE J476A – J516



Approved fitting series for hose types:

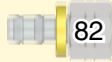

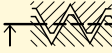
XXXX.XX.XX Part Number 	 Hose I.D.				 Thread NPTF	A mm	B mm	H Inch
	DN	Inch	Size	mm				
30282-4-4B	6	1/4	-4	6,3	1/4x18	40	21	3/4
30282-4-4C-SM	6	1/4	-4	6,3	1/4x18	40	21	19
30282-6-6B	10	3/8	-6	9,5	3/8x18	46	23	7/8
30282-8-8C	12	1/2	-8	12,7	1/2x14	55	28	1-1/16
30282-8-8B	12	1/2	-8	12,7	1/2x14	55	28	1-1/16

Material: steel chromium(VI) free plated
 B: Brass
 C: Stainless Steel
 K: Without plastic ring
 SM: Metric Hexagon

Information about standard products or non-standard products can be found in the current price list.
 Dimensions shown may be changed at any time without prior notice.



03 – Male JIC 37° – Rigid – Straight

ISO12151-5-S – AGJ



Approved fitting series for hose types:

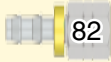

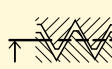
XXXX.XX.XX Part Number 	 Hose I.D.				 Thread UNF	A	B	H
	DN	Inch	Size	mm				
30382-4-4	6	1/4	-4	6,3	7/16x20	40	21	1/2
30382-4-4B	6	1/4	-4	6,3	7/16x20	40	21	12
30382-6-6	10	3/8	-6	9,5	9/16x18	45	22	5/8
30382-6-6B	10	3/8	-6	9,5	9/16x18	45	22	5/8
30382-8-8	12	1/2	-8	12,7	3/4x16	52	26	3/4
30382-8-8B	12	1/2	-8	12,7	3/4x16	52	26	3/4
30382-12-12	20	3/4	-12	19,1	1-1/16x12	69	32	1-1/8
30382-12-12B	20	3/4	-12	19,1	1-1/16x12	69	32	1-1/8

Material: steel chromium(VI) free plated
B: Brass

Information about standard products or non-standard products can be found in the current price list.
Dimensions shown may be changed at any time without prior notice.

06/68 - Female - JIC 37° / SAE 45° Dual Flare - Swivel - Straight

ISO12151-5-SWS - DKJ

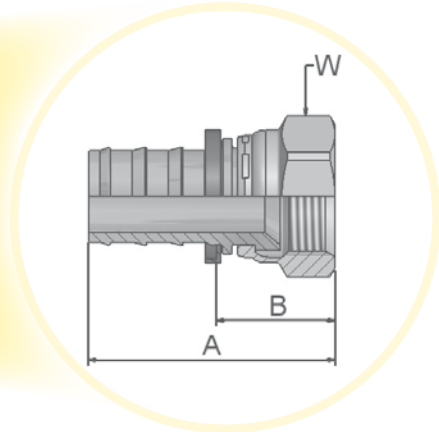

Approved fitting series for hose types:



XXXX-XX-XX Part Number 	Hose I.D.				Thread UNF	A mm	B mm	W Inch
	DN	Inch	Size	mm				
30682-4-4	6	1/4	-4	6,3	7/16x20	39	19	9/16
30682-4-4-SM	6	1/4	-4	6,3	7/16x20	40	21	14
30682-4-4B	6	1/4	-4	6,3	7/16x20	39	19	9/16
30682-4-4C	6	1/4	-4	6,3	7/16x20	39	19	9/16
30682-5-4	6	1/4	-4	6,3	1/2x20	40	21	5/8
30682-5-4B	6	1/4	-4	6,3	1/2x20	40	21	5/8
36882-5-4C-SM	6	1/4	-4	6,3	1/2x20	40	21	17
30682-6-4B	6	1/4	-4	6,3	9/16x18	42	22	11/16
30682-5-6B	10	3/8	-6	9,5	1/2x20	44	21	5/8
30682-6-6	10	3/8	-6	9,5	9/16x18	46	22	11/16
30682-6-6-SM	10	3/8	-6	9,5	9/16x18	45	22	19
30682-6-6B-SM	10	3/8	-6	9,5	9/16x18	45	22	19
30682-6-6C	10	3/8	-6	9,5	9/16x18	46	22	11/16
30682-6-6C-SM	10	3/8	-6	9,5	9/16x18	45	22	19
30682-8-6B	10	3/8	-6	9,5	3/4x16	47	24	7/8
36882-8-6-SM	10	3/8	-6	9,5	3/4x16	48	25	22
36882-8-6C-SM	10	3/8	-6	9,5	3/4x16	48	25	22
30682-8-8	12	1/2	-8	12,7	3/4x16	51	25	7/8
30682-8-8B	12	1/2	-8	12,7	3/4x16	51	25	7/8
30682-10-8B	12	1/2	-8	12,7	7/8x14	52	25	1
30682-10-8-SM	12	1/2	-8	12,7	7/8x14	65	28	27
30682-10-10	6	5/8	-10	15,9	7/8x14	52	25	1
30682-10-10-SM	16	5/8	-10	15,9	7/8x14	65	28	27
30682-10-10B	16	5/8	-10	15,9	7/8x14	62	25	1
36882-10-10C-SM	16	5/8	-10	15,9	7/8x14	65	28	27
30682-12-12	20	3/4	-12	19,1	1-1/16x12	67	30	1-1/4
30682-12-12-SM	20	3/4	-12	19,1	1-1/16x12	67	30	32
30682-12-12B	20	3/4	-12	19,1	1-1/16x12	67	30	1-1/4
30682-12-12B-SM	20	3/4	-12	19,1	1-1/16x12	67	30	32
30682-12-12C	20	3/4	-12	19,1	1-1/16x12	67	30	1-1/4
30682-12-12C-SM	20	3/4	-12	19,1	1-1/16x12	67	30	32
30682-16-16-SM	25	1	-16	25,4	1-5/16x12	70	33	41
30682-16-16C-SM	25	1	-16	25,4	1-5/16x12	70	33	41

Material: steel
chromium(VI)
free plated
C:
Material:
Stainless Steel
SM:
Metric Hexagon

Information about standard products or non-standard products can be found in the current price list.
Dimensions shown may be changed at any time without prior notice.



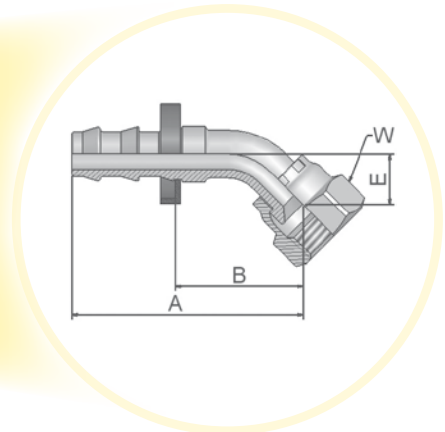
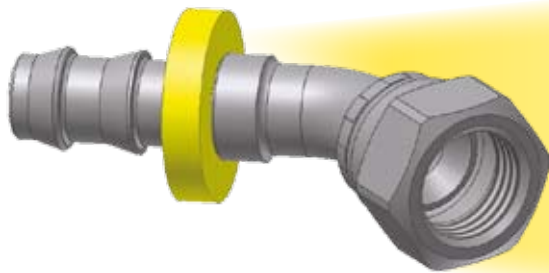

37/3V – Female JIC 37° /SAE 45° – Dual Flare – Swivel Female 45° Elbow

ISO 12151-5-SWE45 – DKJ 45°

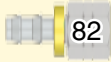

Approved fitting series for hose types:

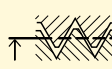

XXXX.XX.XX Part Number 	 Hose I.D.				 Thread UNF	A	B	E	 W
	DN	Inch	Size	mm					
33782-4-4	6	1/4	-4	6,3	7/16x20	39	20	8	9/16
33V82-4-4B-SM	6	1/4	-4	6,3	7/16x20	44	25	10	17
33782-6-6	10	3/8	-6	9,5	9/16x18	53	30	10	11/16
33782-6-6-SM	10	3/8	-6	9,5	9/16x18	51	28	11	19
33782-8-8	12	1/2	-8	12,7	3/4x16	54	35	14	7/8

Material: steel chromium(VI) free plated
 B: Brass
 SM: Metric Hexagon

Information about standard products or non-standard products can be found in the current price list.
 Dimensions shown may be changed at any time without prior notice.



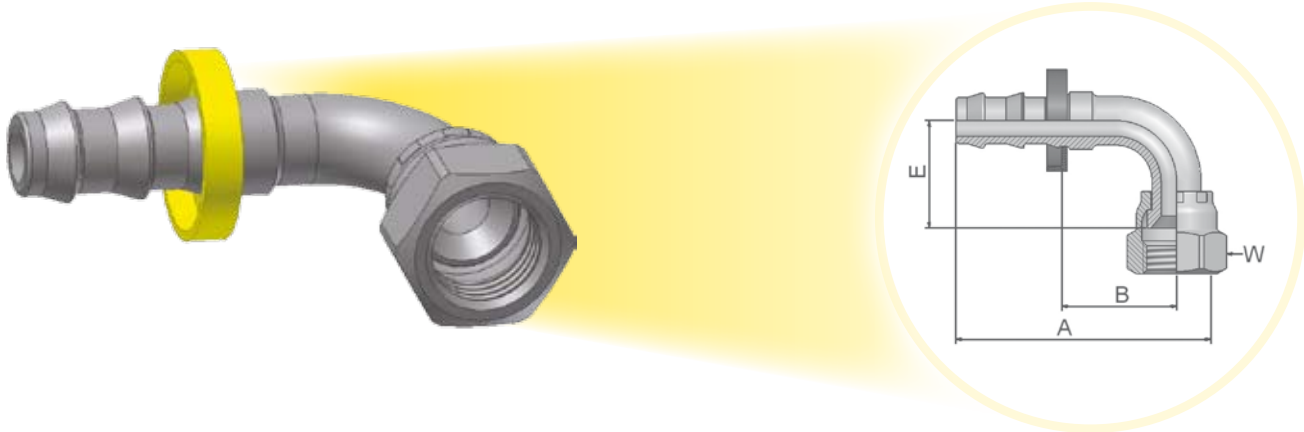

39/3W – Female JIC 37° / SAE 45° – Dual Flare – Swivel Female 90° Elbow

ISO 12151-5-SWES – DKJ 90°

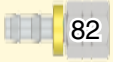

Approved fitting series for hose types:

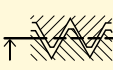

XXXX·XX·XX Part Number 	Hose I.D. 				Thread UNF 	A mm	B mm	E mm	W Inch 
	DN	Inch	Size	mm					
33982-4-4	6	1/4	-4	6,3	7/16x20	39	20	17	5/8
33W82-4-4C-SM	6	1/4	-4	6,3	7/16x20	39	20	21	17
33982-6-6	10	3/8	-6	9,5	9/16x18	50	28	22	11/16
33982-6-6-SM	10	3/8	-6	9,5	9/16x18	47	25	23	19
33982-6-6C-SM	10	3/8	-6	9,5	9/16x18	47	25	23	19
33982-8-8	12	1/2	-8	12,7	3/4x16	59	33	28	7/8
33W82-8-8-SM	12	1/2	-8	12,7	3/4x16	55	29	28	22
33982-10-10	16	5/8	-10	15,9	7/8x14	74	37	31	1
33982-12-12	20	3/4	-12	19,1	1-1/16x12	84	46	46	1-1/4
33982-12-12-SM	20	3/4	-12	19,1	1-1/16x12	83	46	48	32

Material: steel chromium(VI) free plated
C: Material: Stainless Steel
SM: Metric Hexagon

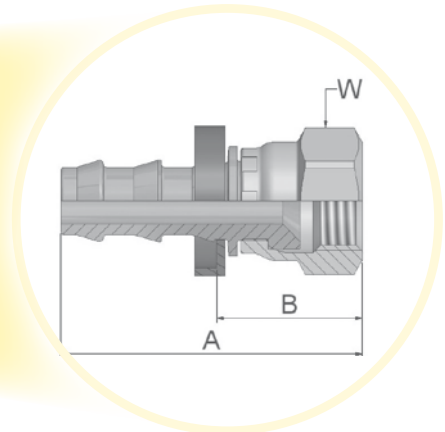
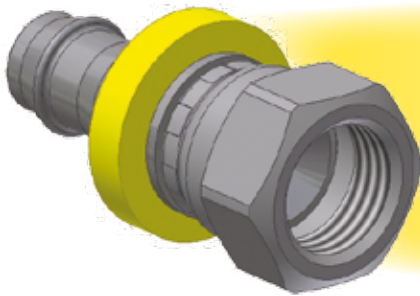

Information about standard products or non-standard products can be found in the current price list.
Dimensions shown may be changed at any time without prior notice.

08 – Female SAE 45° Swivel



Approved fitting series for hose types:

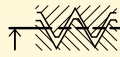

XXXX.XX.XX Part Number 	 Hose I.D.				 Thread UNF	A	B	W
	DN	Inch	Size	mm				
30882-4-4	6	1/4	-4	6,3	7/16x20	39	19	9/16
30882-4-4B	6	1/4	-4	6,3	7/16x20	39	19	9/16
30882-5-4B	6	1/4	-4	6,3	1/2x20	40	21	5/8
30882-6-6	10	3/8	-6	9,5	5/8x18	46	23	3/4
30882-6-6B	10	3/8	-6	9,5	5/8x18	46	23	3/4
30882-8-8	12	1/2	-8	12,7	3/4x16	51	25	7/8
30882-8-8B	12	1/2	-8	12,7	3/4x16	51	25	7/8
30882-10-10	16	5/8	-10	15,9	7/8x14	65	28	1
30882-10-10B	16	5/8	-10	15,9	7/8x14	65	28	1
30882-12-12	20	3/4	-12	19,1	1-1/16x14	67	30	1-1/4
30882-12-12B	20	3/4	-12	19,1	1-1/16x14	67	30	1-1/4

Material: steel chromium(VI) free plated
B: Brass

Information about standard products or non-standard products can be found in the current price list.
Dimensions shown may be changed at any time without prior notice.



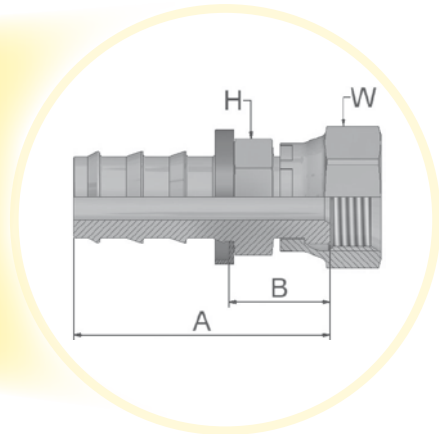
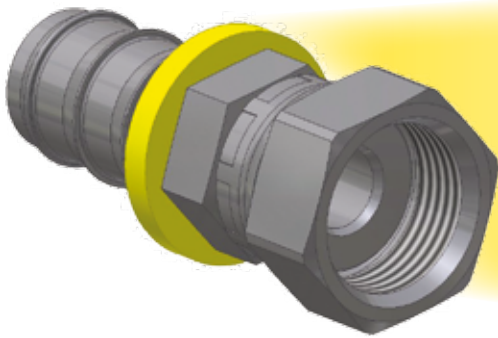

JC – Female ORFS – Swivel – Straight – Short

ISO 12151-1 – SWSA – SAE J516 – ORFS

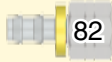

Approved fitting series for hose types:

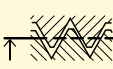

XXXX.XX.XX Part Number 	 Hose I.D.				 Thread UNF	A mm	B mm	H Inch	 W Inch
	DN	Inch	Size	mm					
3JC82-4-4	6	1/4	-4	6,3	9/16x18	36	17	9/16	11/16
3JC82-6-6	10	3/8	-6	9,5	11/16x16	40	18	11/16	13/16
3JC82-6-6-SM	10	3/8	-6	9,5	11/16x16	41	18	19	22
3JC82-8-6-SM	10	3/8	-6	9,5	13/16x16	43	20	22	24
3JC82-8-8	12	1/2	-8	12,7	13/16x16	47	20	22	15/16
3JC82-8-8-SM	12	1/2	-8	12,7	13/16x16	47	20	22	24
3JC82-8-10	16	5/8	-10	15,9	13/16x16	57	21	3/4	15/16
3JC82-8-10-SM	16	5/8	-10	15,9	13/16x16	57	21	22	24
3JC82-10-10	16	5/8	-10	15,9	1x14	61	24	15/16	1-1/8
3JC82-10-12	20	3/4	-12	19,1	1x14	61	24	1	1-1/8
3JC82-12-12	20	3/4	-12	19,1	1-3/16x12	67	30	1-1/8	1-3/8

Material: steel chromium(VI) free plated
SM: Metric Hexagon



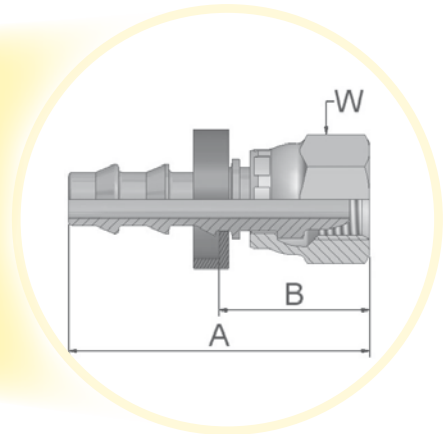
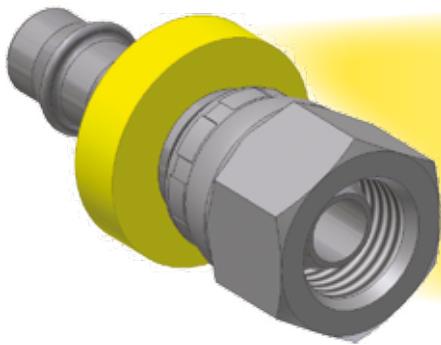

Information about standard products or non-standard products can be found in the current price list.
Dimensions shown may be changed at any time without prior notice.

FF - Metru-Lok Swivel Female

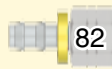

Approved fitting series for hose types:

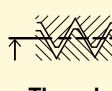

XXXX.XX.XX Part Number 	 Hose I.D.				 Thread metric	Tube O.D.	A	B	 W
	DN	Inch	Size	mm					
3FF82-6-4B	6	1/4	-4	6,3	M10x1	6	36	16	14
3FF82-8-4B	6	1/4	-4	6,3	M12x1	8	31	12	14
3FF82-10-6B	10	3/8	-6	9,5	M14x1	10	35	12	17
3FF82-12-6B	10	3/8	-6	9,5	M16x1	12	35	12	19
3FF82-14-8B	12	1/2	-8	12,7	M18x1	14	38	12	22
3FF82-16-8B	12	1/2	-8	12,7	M22x1,5	16	38	12	24
3FF82-18-10B	16	5/8	-10	15,9	M24x1,5	18	51	15	27
3FF82-22-12B	20	3/4	-12	19,1	M28x1,5	22	51	15	32

Material: Brass (B)





Information about standard products or non-standard products can be found in the current price list. Dimensions shown may be changed at any time without prior notice.

AF – Male BSP Parallel Pipe – Rigid – Straight with O-ring Seal

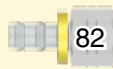

Approved fitting series for hose types:

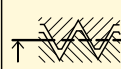

XXXX·XX·XX Part Number 	 Hose I.D.				 Thread BSP	A mm	B mm	 W mm
	DN	Inch	Size	mm				
3AF82-2-4B	6	1/4	-4	6,3	1/8x28	34	15	17
3AF82-4-4B	6	1/4	-4	6,3	1/4x19	39	20	19
3AF82-4-4C	6	1/4	-4	6,3	1/4x19	39	20	19
3AF82-4-6B	10	3/8	-6	9,5	1/4x19	43	20	19
3AF82-6-6B	10	3/8	-6	9,5	3/8x19	46	23	22
3AF82-6-8B	12	1/2	-8	12,7	3/8x19	49	22	22
3AF82-8-8B	12	1/2	-8	12,7	1/2x14	53	26	27
3AF82-8-10B	16	5/8	-10	15,9	1/2x14	63	26	27

Material: Brass (B)

C: Material: Stainless Steel

Fittings with standard O-ring seals can be used for temperature from -30 °C up to +150 °C

Information about standard products or non-standard products can be found in the current price list.
Dimensions shown may be changed at any time without prior notice.



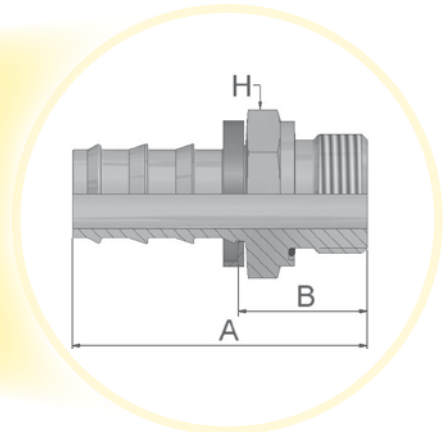

NM- Male BSP Parallel Pipe – L Series – Rigid – Straight – ED-Seal

ISO 1179



Approved fitting series for hose types:

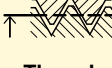

XXXX.XX.XX Part Number 	 Hose I.D.				 Thread BSP	A	B	 W
	DN	Inch	Size	mm				
3NM82-6-8B	12	1/2	-8	12,7	3/8x19	52	26	22
3NM82-8-8B	12	1/2	-8	12,7	1/2x14	55	28	27
3NM82-12-12B	20	3/4	-12	19,1	3/4x14	65	28	32

Material: Brass (B)
 Hose fittings are delivered with ED-Seal. Working temperature from -30 °C up to +150 °C.

Information about standard products or non-standard products can be found in the current price list.
 Dimensions shown may be changed at any time without prior notice.

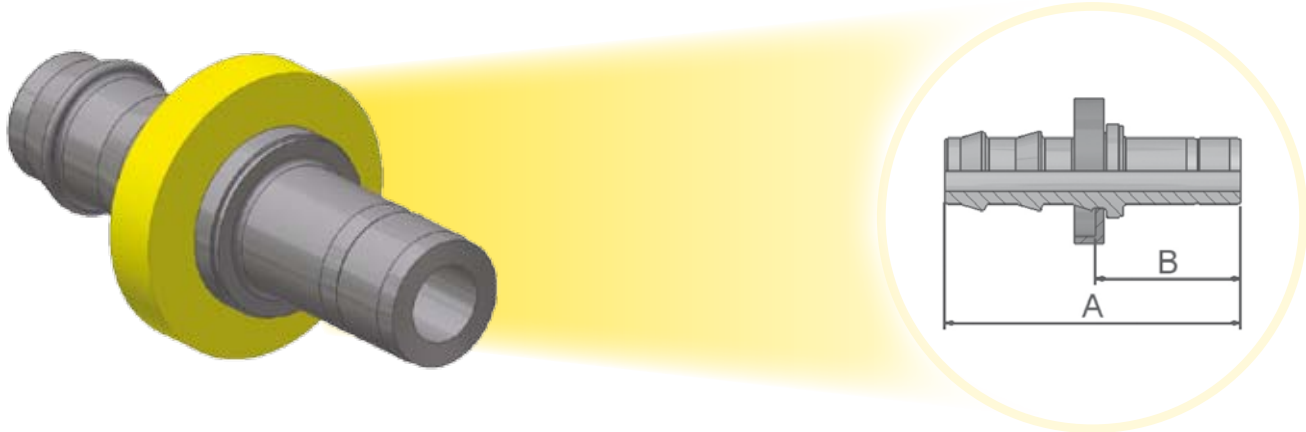

YW – Male Standpipe – Rigid – Straight – A-Lok

Metric Size Tube O.D. with Vee Notch



Approved fitting series for hose types:

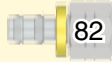

XXXX.XX.XX Part Number 	 Hose I.D.				A	B
	DN	Inch	Size	mm	mm	mm
3YW82-6-4C-ROUND	6	1/4	-4	6,3	39	20
3YW82-8-4C-ROUND	6	1/4	-4	6,3	40	21
3YW82-10-6C-ROUND	10	3/8	-6	9,5	44	22
3YW82-12-8C-ROUND	12	1/2	-8	12,7	54	27
3YW82-18-10C-ROUND	16	5/8	-10	15,9	65	29

Material: Stainless Steel

Information about standard products or non-standard products can be found in the current price list. Dimensions shown may be changed at any time without prior notice.



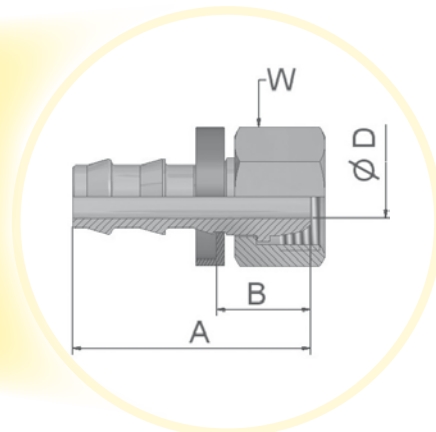
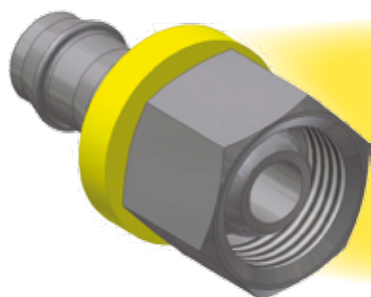

VW121- BSP Swivel Female

(VW-Norm 39-V-16631)

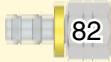

Approved fitting series for hose types:

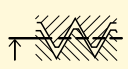

XXXX.XX.XX Part Number 	 Hose I.D.				 Thread BSP	A	B	D	 W
	DN	Inch	Size	mm					
VW121-8937*	6	1/4	-4	6,3	1/4x19	32	13	5	17
VW121-8938**	10	3/8	-6	9,5	3/8x19	38	15	7,5	19
VW121-8939**	14	1/2	-8	12,7	1/2x14	46	19	11	27
VW121-8940**	16	5/8	-10	15,9	3/4x14	58	21	14	32
VW121-8941**	20	3/4	-12	19,1	1x11	53	16	17	41

*stainless steel nipple, steel nut
 **brass nipple, steel nut

Information about standard products or non-standard products can be found in the current price list.
 Dimensions shown may be changed at any time without prior notice.

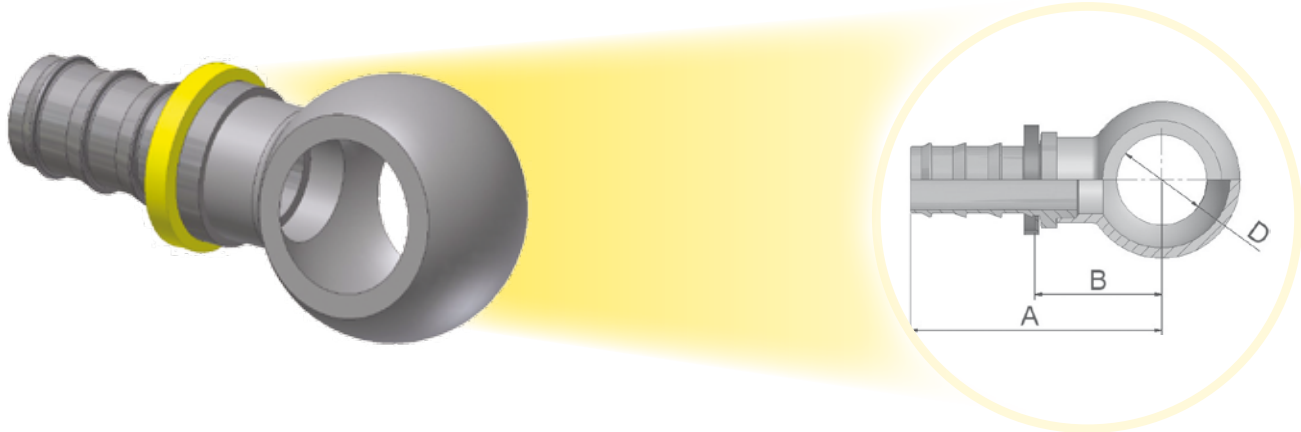

49 – Metric Banjo – Straight

DIN 7642



Approved fitting series for hose types:



XXXX.XX.XX Part Number 	 Hose I.D.				D	A	B
	DN	Inch	Size	mm			
34982-8-4	6	1/4	-4	6,3	8	36	17
34982-10-4	6	1/4	-4	6,3	10	38	19
34982-12-4	6	1/4	-4	6,3	12	40	21
34982-14-4	6	1/4	-4	6,3	14	42	23
34982-14-4C	6	1/4	-4	6,3	14	42	23
34982-10-6	10	3/8	-6	9,5	10	42	19
34982-12-6	10	3/8	-6	9,5	12	44	21
34982-14-6	10	3/8	-6	9,5	14	47	24
34982-14-6C	10	3/8	-6	9,5	14	47	24
34982-16-6	10	3/8	-6	9,5	16	49	26
34982-17-6	10	3/8	-6	9,5	17	49	26
34982-17-6C	10	3/8	-6	9,5	17	49	26
34982-14-8	12	1/2	-8	12,7	14	51	25
34982-18-8	12	1/2	-8	12,7	18	55	28
34982-22-8	12	1/2	-8	12,7	22	58	31
34982-22-10	16	5/8	-10	15,9	22	68	32
34982-26-12	20	3/4	-12	19,1	26	73	37

Material: steel chromium(VI) free plated
C: Material: Stainless Steel



Information about standard products or non-standard products can be found in the current price list.
Dimensions shown may be changed at any time without prior notice.

82 - Push-Lok® Union



Approved fitting series for hose types:

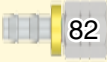

XXXX.XX.XX Part Number 	 Hose I.D.				A
	DN	Inch	Size	mm	mm
38282-4-4	6	1/4	-4	6,3	45
38282-4-4B	6	1/4	-4	6,3	45
38282-6-6	10	3/8	-6	9,5	54
38282-6-6B	10	3/8	-6	9,5	54
38282-8-8	12	1/2	-8	12,7	64
38282-8-8B	12	1/2	-8	12,7	64
38282-10-10	16	5/8	-10	15,9	84
38282-10-10B	16	5/8	-10	15,9	84
38282-12-12	20	3/4	-12	19,1	84
38282-12-12B	20	3/4	-12	19,1	84

Material: steel chromium(VI) free plated
B: Brass

Information about standard products or non-standard products can be found in the current price list.
Dimensions shown may be changed at any time without prior notice.

DP – Metric Swivel Female Tee / Male Stud

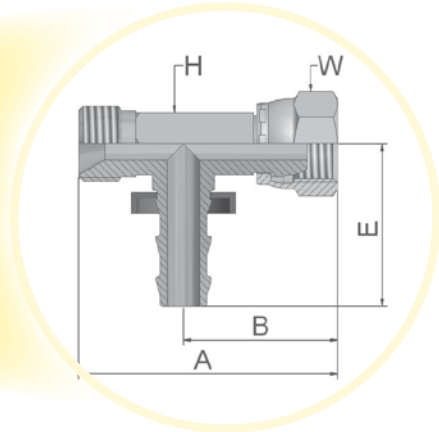
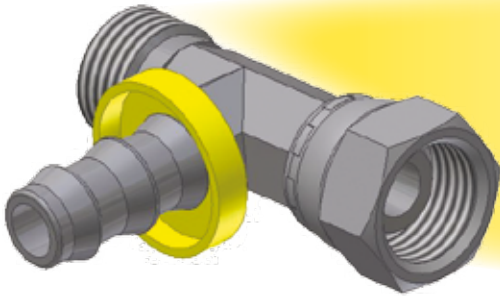

Approved fitting series for hose types:

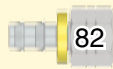

XXXX·XX·XX Part Number 	Hose I.D.				Thread metric	A mm	B mm	E mm	H mm	W mm
	DN	Inch	Size	mm						
DP-6-6-4BK	6	1/4	-4	6,3	M12x1	43	24	30	11	14
DP-8-8-4BK	6	1/4	-4	6,3	M14x1,5	43	24	30	11	14
DP-10-10-6BK	10	3/8	-6	9,5	M16x1,5	48	26	34	13	19
DP-15-15-8BK	12	1/2	-8	12,7	M22x1,5	58	32	42	17	27

B & BK parts have brass nipples and steel nuts.

K: Without plastic ring

Standard nipples are stocked without plastic collar. If you need a collar, delete K from the part number.



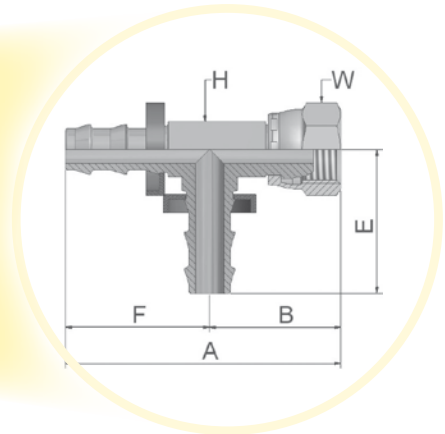
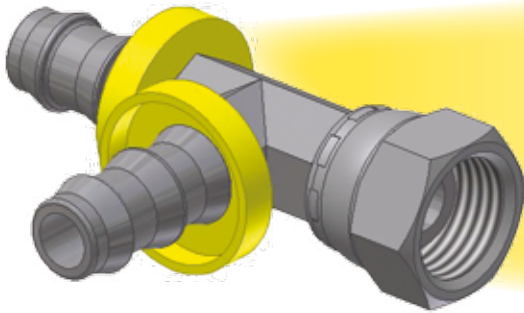

Information about standard products or non-standard products can be found in the current price list. Dimensions shown may be changed at any time without prior notice.

DR – Metric Swivel Female Tee



Approved fitting series for hose types:

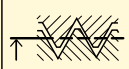

XXXX.XX.XX Part Number 	 Hose I.D.				 Thread metric	A	B	E	F	 H	 W
	DN	Inch	Size	mm							
DR-6-4-4BK	6	1/4	-4	6,3	M12x1	54	24	30	30	11	14
DR-10-6-6BK	10	3/8	-6	9,5	M16x1,5	59	25	34	34	13	19
DR-15-8-8BK	12	1/2	-8	12,7	M22x1,5	74	32	42	42	17	27

Material: steel chromium(VI) free plated
 B: Brass
 C: Stainless Steel
 K: Without plastic ring

Information about standard products or non-standard products can be found in the current price list.
 Dimensions shown may be changed at any time without prior notice.

Assembly Instructions



1. Cut the hose right angled with a sharp knife. If necessary it is possible to use a lubricant (water/ soap solution with 5 % soap fluid and 95 % water) for easy assembly.

2. Insert fitting into hose until first barb is in hose. Place end of fitting against a flat object (bench, door, wall) and grip hose approximately 1" from end and push with a steady force until end of hose is covered by yellow plastic collar. Alternatively please use the Parker Assembly Tool No. 611050G.

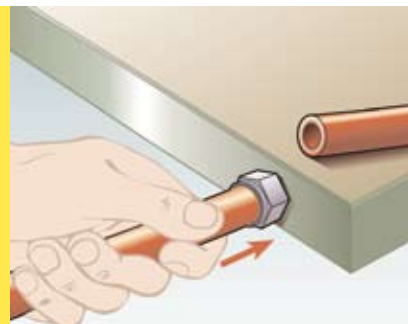

Attention!

During assembly, please keep in mind that Push-Lok fittings will provide an effective grip only when the Push-Lok hose is pushed fully on the insert, where the cropped end of the hose should be fully concealed by the plastic collar. **For easy assembly of hose 830M, 837BM and 837PU please use only Push-Lok Assembly Oil No. H896137.** Push-Lok Assembly Oil is free from wetting disturbing substances. Don't use oil, lubricant or soap fluids for this hose!

Disassembly Instructions

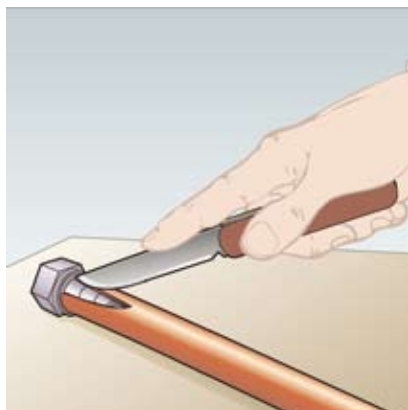

1. Cut lengthwise along a line at approximately a 20 angle from centre line of hose. The cut should be approximately 1" long. Be careful not to nick barbs when cutting the hose.

2. Grip hose and give a sharp down-ward tug to disengage from fitting.

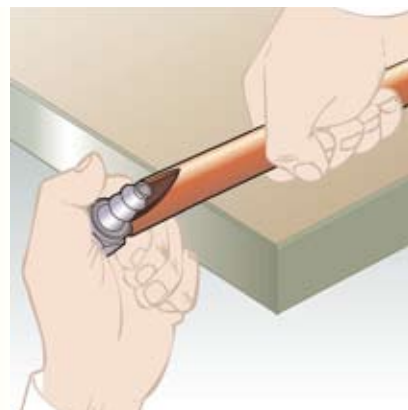

Attention!

Before re-use of the nipple please check nipple for damage. Damaged nipples can cause leakage.

Assembly Tool

Tool designed for assembly of Push-Lok fittings and hose in all sizes. Toggle actions greatly reduce effort necessary to hold hose and press in fitting. Only a few pounds of force is needed on either handle to quickly assemble any size. Overall length: 320 mm, Weight: ca. 2,2 kg

Part No. 611050G

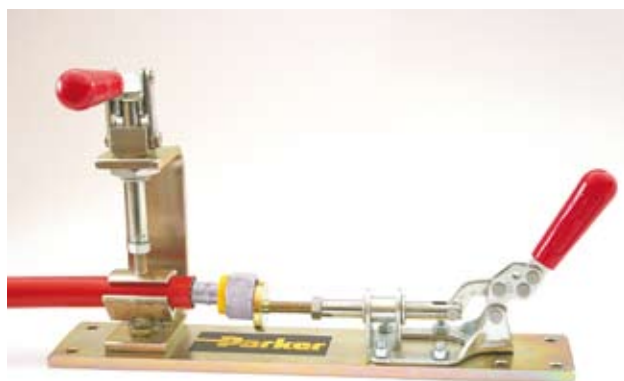

Push-Lok Assembly Oil H896137
1-litre bottle Part No. H896137



Low Pressure Speciality Hose and Fittings

***- the right solution for special
applications and requirements***

The low pressure speciality hose range offers high performance for special requirements. A wide range of different hose types in rubber is available, with textile-braided or fire-retardant covers.

- ▶ The widest range of SAE 100 R5 hoses in the world
- ▶ Proven, safe and easy self-assembly system
- ▶ Large bore sizes available
- ▶ High working temperatures
- ▶ One fitting series for all SAE 100 R5 and similar hoses
- ▶ Series 26 fittings replace previous and expensive screw reusable fittings



Parkrimp® *No-Skive*

The system for fast and leak-free assemblies

- No skiving tool needed
- No need to remove the cover
- Crimps one piece fittings
- Parkalign positions the fittings in the die perfectly every time
- Quick and easy: no gauges to set on the machine
- Portable machines for field repair
- Meets EN safety regulations

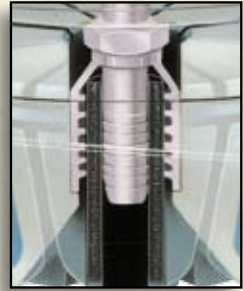

Parkalign®
Parker's exclusive Parkalign® positions the fitting in the dies perfectly every time.

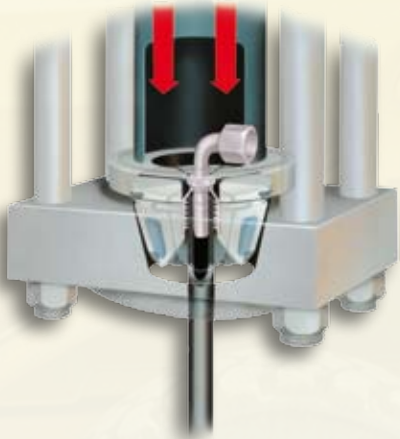

Parker's colour-coded die sets

No loose parts to mismatch or misplace – die set segments linked together. Die sets provide 360° evenly applied crimping forces for an ideal crimp result.



The perfect match

The complete system from one source. *No-Skive* hose, *No-Skive* fitting and crimping machine with world-wide guarantee and availability.



The definitive hose range for all low pressure applications



Index

Speciality Hoses

B2

201	– <i>No-Skive</i> Airbrake Hose (up to +150 °C working temperature) – SAE 100 R5	B2a-1
206	– <i>No-Skive</i> Airbrake Hose (working temperature (-48 °C) – SAE 100 R5	B2a-2
213	– <i>No-Skive</i> High-Temperature Hose (for engines and pressed air systems)	B2a-3
221FR	– <i>No-Skive</i> Fire-Retardant Hose	B2a-4
285	– Air Conditioning and Refrigerant Hose SAE J2064 Typ C, Class 1	B2a-5
293	– <i>No-Skive</i> High Temperature Hose Engine and air brake/truck hose.	B2a-6
601	– <i>No-Skive</i> Hose SAE 100 R3	B2a-7
611HT	– <i>No-Skive</i> Hose High Temperature Textile-Hose	B2a-8
681DB	– <i>No-Skive</i> 2TE-Hose (with approvals for rail transportation) EN 854-2TE .	B2a-9
Crimp Fittings: 26 Series		B2b-1–B2b-20

201 – *No-Skive* Airbrake Hose

SAE 100 R5 / SAE J1402 All

Main Features

- Textile braided cover
- *No-Skive* hose construction
- 150 °C working temperature



Primary Applications/Restrictions

Transportation: Air brake hose
General: Medium pressure applications

Applicable Specifications

SAE 100 R5 , SAE J1402 All, D. O. T. FMVSS 106-All

Hose Construction

Tube: Synthetic rubber
Reinforcement: A textile inner braid and a high tensile steel wire braid
Cover: Rubber layer and a textile braided cover

Recommended Fluids

Petroleum based hydraulic fluids, water-glycol and water-oil emulsion hydraulic fluids, grease, lubricants, crude and fuel oils, air and water.
 Consult the chemical compatibility section on page Ab-16 for more detailed information.

Temperature Range

-40 °C up to +150 °C

Exception: Air max. 70 °C
 Water max. 85 °C

Fittings Series



XXXX-XX-XX Part Number	Hose I.D.				Hose O.D.	Pressure rating				Vacuum kilo Pascal*1 kPa	min. bend radius mm	Weight kg/m
	DN	Inch	Size	mm	mm	max. dynamic working pressure		min. burst pressure				
						MPa	psi	MPa	psi			
201-4		3/16	-4	5,0	12,2	20,7	3000	83	12000	95	75	0,22
201-5		1/4	-5	6,3	14,8	20,7	3000	83	12000	95	85	0,27
201-6		5/16	-6	8,0	17,2	15,5	2250	62	9000	95	100	0,34
201-8		13/32	-8	10,0	19,5	13,8	2000	55	8000	95	120	0,40
201-10		1/2	-10	12,5	23,4	12,0	1750	48	7000	95	140	0,55
201-12		5/8	-12	16,0	27,4	10,3	1500	41	6000	95	165	0,68
201-16		7/8	-16	22,0	31,4	5,5	800	22	3200	67	185	0,68
201-20		1-1/8	-20	29,0	38,1	4,3	625	17	2500	67	230	0,76
201-24		1-3/8	-24	35,0	44,5	3,5	500	14	2000	51	265	1,01
201-32		1-13/16	-32	46,0	56,4	2,4	350	10	1400	37	335	1,32

*1 = the vacuum values listed in the table are vacuum pressure values in kPa. For an absolute value subtract the table value from 101kPa
 The combination of high temperature and high pressure could reduce the hose life.
 The maximum working pressures shown in the table are for service up to a maximum temperature of 100 °C. For use of higher temperatures, consult the pressure/temperature curve in section A for the reduced maximum working pressure.

Information about standard products or non-standard products can be found in the current price list.
 Dimensions shown may be changed at any time without prior notice.

206 – *No-Skive* Airbrake Hose

SAE 100 R5 / SAE J1402 All

Main Features

- Blue textile braided cover
- *No-Skive* hose construction
- For very low (-48 °C) working temperature

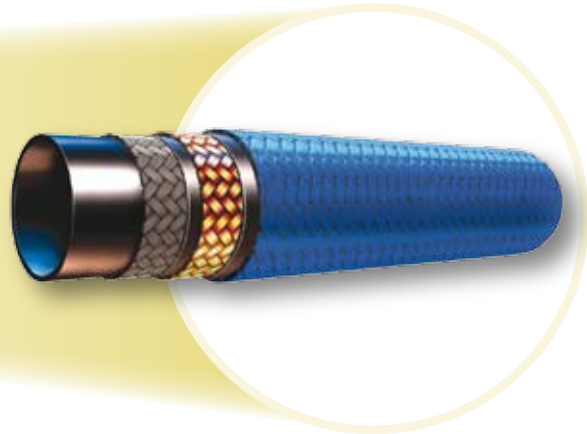

Primary Applications/Restrictions

Transportation: Air brake hose
General: Medium pressure applications

Applicable Specifications

SAE 100 R5 , SAE J1402 All, D. O. T. FMVSS 106-All

Hose Construction

Tube: Parker PKR-elastomer tube
Reinforcement: A textile inner braid and a high tensile steel wire braid
Cover: Rubber layer and a blue textile braided cover

Recommended Fluids

Petroleum based hydraulic fluids, water-glycol and water-oil emulsion hydraulic fluids, grease, lubricants, crude and fuel oils, air and water.
Consult the chemical compatibility section on page Ab-16 for more detailed information.

Temperature Range

-48 °C up to +150 °C
Exception: Air max. 100 °C
Water max. 85 °C

Fittings Series



Part Number XXXX-XX-XX	Hose I.D.				Hose O.D. mm	Pressure rating				Vacuum kilo Pascal*1 kPa	min. bend radius mm	Weight kg/m
	DN	Inch	Size	mm		max. dynamic working pressure MPa	psi	min. burst pressure MPa	psi			
206-4		3/16	-4	5,0	13,2	20,7	3000	83	12000	95	75	0,22
206-5		1/4	-5	6,3	14,8	20,7	3000	83	12000	95	85	0,27
206-6		5/16	-6	8,0	17,1	15,5	2250	62	9000	95	90	0,34
206-8		13/32	-8	10,0	19,5	13,8	2000	55	8000	95	90	0,40
206-10		1/2	-10	12,5	23,4	12,0	1750	48	7000	95	100	0,55
206-12		5/8	-12	16,0	27,4	10,3	1500	41	6000	95	100	0,68
206-16		7/8	-16	22,0	31,4	5,5	800	22	3200	67	100	0,68
206-20		1-1/8	-20	29,0	38,1	4,3	625	17	2500	67	140	0,76
206-24		1-3/8	-24	35,0	44,5	3,5	500	14	2000	51	190	1,01
206-32		1-13/16	-32	46,0	56,4	2,4	350	10	1400	37	335	1,32

*1 = the vacuum values listed in the table are vacuum pressure values in kPa. For an absolute value subtract the table value from 101kPa
The combination of high temperature and high pressure could reduce the hose life.
The maximum working pressures shown in the table are for service up to a maximum temperature of 100 °C. For use of higher temperatures, consult the pressure/temperature curve in section A for the reduced maximum working pressure.

Information about standard products or non-standard products can be found in the current price list.
Dimensions shown may be changed at any time without prior notice.

213 – *No-Skive* High-Temperature Hose

For engines and pressed air systems

Main Features

- *No-Skive* hose construction
- Ideal for high-temperature and small bend radii applications
- Compatible with a large range of fluids



Primary Applications/Restrictions

Transportation: Air brake hose
Compressors: Compressed air hose

Applicable Specifications

SAE J1402 AI, D.O.T. FMVSS 106-AI

Hose Construction

Tube: Parker PKR-elastomer tube
Reinforcement: A textile inner braid and a high tensile steel wire braid
Cover: Rubber layer and a black textile braided cover include 2 green strips

Recommended Fluids

Petroleum based hydraulic fluids, water-glycol and water-oil emulsion hydraulic fluids, grease, lubricants, crude and fuel oils, air and water.
 Consult the chemical compatibility section on page Ab-16 for more detailed information.

Temperature Range

-45 °C up to +150 °C
 Exception: Air max. 100 °C
 Water max. 85 °C

Fittings Series



XXXX-XX-XX Part Number	Hose I.D.				Hose O.D.	Pressure rating				min. bend radius mm	Weight kg/m
	DN	Inch	Size	mm	mm	max. dynamic working pressure		min. burst pressure			
						MPa	psi	MPa	psi		
213-4		3/16	-4	5,0	12,5	13,8	2000	55,0	8000	20	0,18
213-5		1/4	-5	6,3	14,1	10,3	1500	41,0	6000	25	0,21
213-6		5/16	-6	8,0	15,7	10,3	1500	41,0	6000	30	0,25
213-8		13/32	-8	10,0	18,7	8,6	1250	34,0	5000	45	0,30
213-10		1/2	-10	12,5	21,1	6,9	1000	28,0	4000	55	0,33
213-12		5/8	-12	16,0	24,3	5,2	750	21,0	3000	70	0,36
213-16		7/8	-16	22,0	30,6	2,8	400	11,0	1600	90	0,45
213-20		1-1/8	-20	29,0	37,8	2,1	300	8,0	1200	115	0,65
213-24		1-3/8	-24	35,0	44,0	1,7	300	8,0	1200	190	0,73
213-32		1-13/16	-32	46,0	54,5	1,4	200	5,5	800	355	1,00

The combination of high temperature and high pressure could reduce the hose life.
 The maximum working pressures shown in the table are for service up to a maximum temperature of 100 °C. For use of higher temperatures, consult the pressure/temperature curve in section A for the reduced maximum working pressure.

Information about standard products or non-standard products can be found in the current price list.
 Dimensions shown may be changed at any time without prior notice.

221FR – *No-Skive*-Fire-Retardant

Marine fuel and engine hose

Main Features

- Fire retardant hose cover
- *No-Skive* hose construction
- Marine approvals

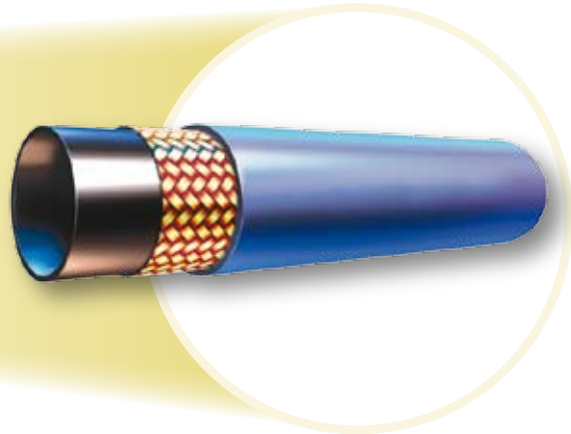

Primary Applications/Restrictions

Marine: Marine fuel hose
General: Where fire retardance is an issue

Applicable Specifications

SAE J1527 R3, USCG Type AI,
 SAE J1942, ISO 7840

Hose Construction

Tube: Fuel and oil-resistant rubber
Reinforcement: A high tensile steel wire braid
Cover: A flame retardant special fiber outer cover

Recommended Fluids

Petroleum based hydraulic fluids, water-glycol and water-oil emulsion hydraulic fluids, grease, lubricants, crude, fuel oils and water.
 Consult the chemical compatibility section on page Ab-16 for more detailed information.

Temperature Range

-20 °C up to +100 °C
 Exception: Air max. +70 °C
 Water max. +85 °C

Fittings Series



Part Number XXXX-XX-XX	Hose I.D.				Hose O.D. mm	Pressure rating				Vacuum kilo Pascal*1 kPa	min. bend radius mm	Weight kg/m
	DN	Inch	Size	mm		max. dynamic working pressure MPa	psi	min. burst pressure MPa	psi			
221FR-5		1/4	-5	6,3	15	3,5	500	14,0	2000	81	25	0,28
221FR-6		5/16	-6	8,0	17	3,5	500	14,0	2000	81	30	0,34
221FR-8		13/32	-8	10,0	20	3,5	500	14,0	2000	81	45	0,42
221FR-10		1/2	-10	12,5	23	3,5	500	14,0	2000	68	55	0,58
221FR-12		5/8	-12	16,0	27	3,5	500	14,0	2000	68	70	0,61
221FR-16		7/8	-16	22,0	31	3,5	500	14,0	2000	68	90	0,70

*1 = the vacuum values listed in the table are vacuum pressure values in kPa. For an absolute value subtract the table value from 101 kPa

Information about standard products or non-standard products can be found in the current price list.
 Dimensions shown may be changed at any time without prior notice.

285 – Air Conditioning and Refrigerant Hose

SAE J2064 Type C, Class 1

Main Features

- *No-Skive* hose construction
- For main refrigerant fluids usable
- Compatible with modern refrigerants



Primary Applications/Restrictions

Air Conditioning: For industrial and mobile applications

Applicable Specifications

SAE J2064 Type C, Class 1

Hose Construction

- Tube:** A nylon barrier between two elastomeric layers
- Reinforcement:** One textile braid
- Cover:** Heat, moisture and ozone resistant rubber

Recommended Fluids

For use with Freon refrigerants 12, 134a and 22. Consult the chemical compatibility section on page Ab-16 for more detailed information.

Temperature Range -30 °C up to +125 °C

Fittings Series



XXXX-XX-XX Part Number	Hose I.D.				Hose O.D.	Pressure rating				Vacuum kilo Pascal*1 kPa	min. bend radius mm	Weight kg/m
	DN	Inch	Size	mm	mm	max. dynamic working pressure	min. burst pressure	MPa	psi			
285-4-RL		3/16	-4	5	12.4	2,7	400	13,7	2000	95	25	0.14
285-6-RL		5/16	-6	8	15.7	2,7	400	13,7	2000	95	38	0.19
285-8-RL		13/32	-8	10	18.8	2,7	400	13,7	2000	95	51	0.25
285-10-RL		1/2	-10	12,5	21.1	2,7	400	13,7	2000	95	64	0.27
285-12-RL		5/8	-12	16	24.4	2,7	400	13,7	2000	95	76	0.34

*1 = the vacuum values listed in the table are vacuum pressure values in kPa. For an absolute value subtract the table value from 101kPa
For size -16 a hose 235-16 is available on request
RL = only available on reels

Information about standard products or non-standard products can be found in the current price list. Dimensions shown may be changed at any time without prior notice.

293 – *No-Skive* High Temperature Hose

Engine and air brake/truck hose

Main Features

- High temperature
– high flex hose performance
- *No-Skive* hose construction
- Wide temperature range

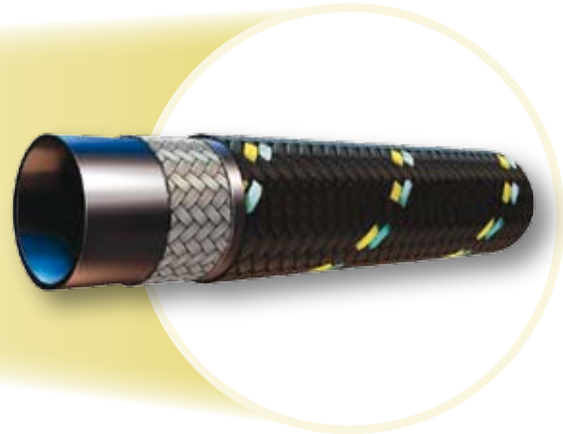

Primary Applications/Restrictions

Truck Market: Air brake hose
Engine cooling circuit

Applicable Specifications

SAE J1402 AI, D.O.T. FMVSS 106

Hose Construction

Tube: Synthetic rubber
Reinforcement: One textile braid
Cover: Black nylon braid

Recommended Fluids

Petroleum-based hydraulic fluids and lubrication oils, diesel fuels and antifreeze solutions; water-, water-oil- and water-glycol emulsion hydraulic fluids. Consult the chemical compatibility section on page Ab-16 for more detailed information.

Temperature Range

-50 °C up to +150 °C
Exception: Air max. 100 °C
Water max. 85 °C

Fittings Series



XXXX-XX-XX Part Number	Hose I.D.				Hose O.D. mm	Pressure rating				min. bend radius mm	Weight kg/m
	DN	Inch	Size	mm		max. dynamic working pressure		min. burst pressure			
						MPa	psi	MPa	psi		
293-4		3/16	-4	5,0	12,5	3.5	500	13.8	2000	15	0.15
293-6		5/16	-6	8,0	15,7	3.5	500	13.8	2000	25	0.22
293-8		13/16	-8	10,0	18,7	3.5	500	13.8	2000	40	0.27
293-10		1/2	-10	12.5	21,1	3.1	450	12.4	1800	50	0.30
293-12		5/8	-12	16.0	24,3	3.1	450	12.4	1800	65	0.33
293-16		7/8	-16	22.0	30,6	3.1	450	12.4	1800	80	0.37

The combination of high temperature and high pressure could reduce the hose life.

Information about standard products or non-standard products can be found in the current price list. Dimensions shown may be changed at any time without prior notice.

601 – No-Skive-Hose

SAE 100 R3

Main Features

- Textile braided reinforcement
- Small bend radii
- Up to +125 °C working temperature

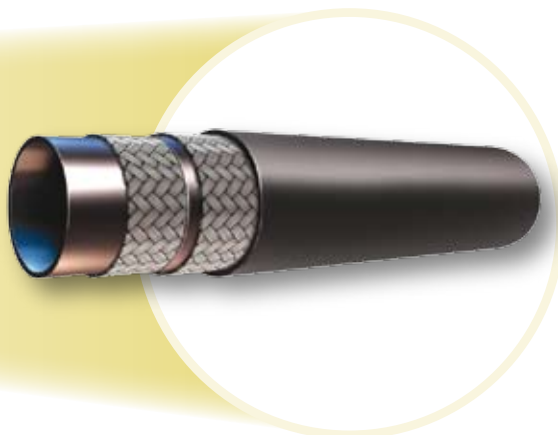

Primary Applications/Restrictions

General Market:

Medium pressure hydraulic application

Applicable Specifications

SAE 100 R3, EN 854-R3

Hose Construction

- Tube:** Synthetic rubber
Reinforcement: Two layers of textile braid
Cover: MSHA accepted synthetic rubber

Recommended Fluids

Petroleum based hydraulic fluids, water-glycol and water-oil emulsion hydraulic fluids, grease, lubricants, crude and fuel oils, air and water.

Consult the chemical compatibility section on page Ab-16 for more detailed information.

Temperature Range

-40 °C up to +125 °C
 Exception: Air max. 70 °C
 Water max. 85 °C

Fittings Series

Available as complete hose assembly*

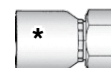

XXXX-XX-XX Part Number	Hose I.D.				Hose O.D.	Pressure rating				min. bend radius mm	Weight kg/m
	DN	Inch	Size	mm	mm	max. dynamic working pressure		min. burst pressure			
						MPa	psi	MPa	psi		
601-4	6	1/4	-4	6,3	14,0	8,6	1250	35,0	5000	75	0,19
601-6	10	3/8	-6	9,5	19,0	7,8	1125	31,0	4500	100	0,33
601-8	12	1/2	-8	12,7	23,0	6,9	1000	28,0	4000	130	0,42
601-12	20	3/4	-12	19,1	32,0	5,2	750	21,0	3000	150	0,64
601-16	25	1	-16	25,4	38,0	3,9	565	16,0	2250	200	0,91

The combination of high temperature and high pressure could reduce the hose life.
 *Parker 43 series fittings are compatible with this hose and are available only upon request

Information about standard products or non-standard products can be found in the current price list.
 Dimensions shown may be changed at any time without prior notice.

611HT – *No-Skive* Hose

High Temperature Textile-Hose

Main Features

- For high demanding applications, such as diesel fuel lines, water cooling or high-temp lines up to +150°C
- MSHA - accepted synthetic rubber cover
- According to EN 854 – R6
- For 2 piece *No-Skive* fittings

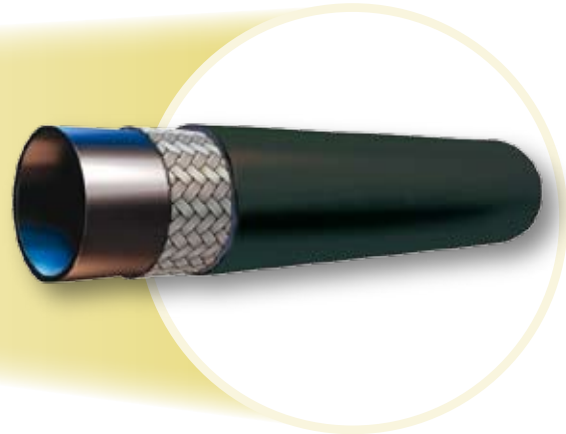

Primary Applications/Restrictions

General Market:

Low pressure hydraulic applications/
high temperature applications

Engine Applications:

Diesel fuel lines, engine cooling circuits

Applicable Specifications

EN 854 - R6

Hose Construction

- Tube:** Synthetic PKR rubber
Reinforcement: One textile braid
Cover: MSHA accepted synthetic rubber

Recommended Fluids

Petroleum-based hydraulic fluids and lubrication oils, diesel fuels and antifreeze solutions; water-glycol* and water-oil emulsion*, air and water. Consult the chemical compatibility section in our catalogue 4400/UK.

Temperature Range

-40 °C up to +150 °C
 Exception: Air max. +100 °C
 Water max. +85 °C

Fittings series

Compatible with Parker 2 piece fittings (47 series nipple and 64 series shell), crimp operation on adjustable crimpers only

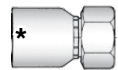

XXXX-XX-XX Part Number	Hose I.D.				Hose O.D.	Pressure rating				min. bend radius mm	Weight kg/m
	DN	Inch	Size	mm	mm	max. dynamic working pressure		min. burst pressure			
						MPa	psi	MPa	psi		
611HT-4	6	1/4	-4	6,3	12,8	2,8	400	11,2	1600	65	0,13
611HT-6	10	3/8	-6	9,5	16,0	2,8	400	11,2	1600	75	0,16
611HT-8	12	1/2	-8	12,7	20,0	2,8	400	11,2	1600	100	0,27
611HT-10	16	5/8	-10	15,9	23,2	2,4	350	9,6	1400	125	0,28
611HT-12	20	3/4	-12	19,0	26,2	2,1	300	8,4	1200	150	0,36

The combination of high temperature and high pressure could reduce the hose life.

* Compatible with Parker 2 piece fittings for use with adjustable crimpers only (47 series nipple and 10064 series shell) – see catalogue 4481

Information about standard products or non-standard products can be found in the current price list. Dimensions shown may be changed at any time without prior notice.

681DB – No-Skive-2TE-hose

EN 854-2TE (with approvals for rail transportation)

Main Features

- Two layers of fabric braid
- Small bend radii
- Flame retardent rubber cover
- Deutsche Bahn (German Railway) approved

Certifications

- German Standard: DIN 5510-2
- French Standard: NF F16-101/102 I2/F3
- British Standard: BS 6853 - Table 4

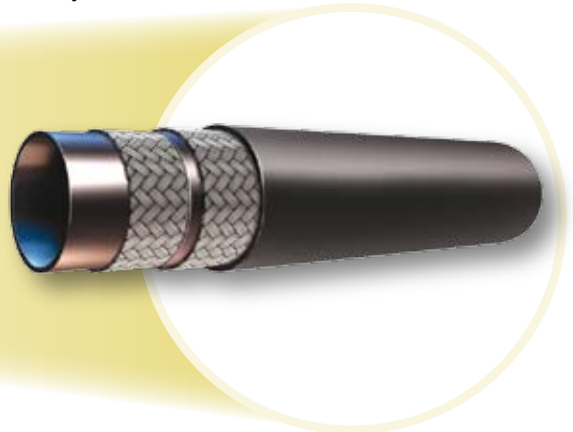

Primary Applications/Restrictions

General Market:

Medium pressure hydraulic application

Rail transportation market:

Hydraulic applications around train vehicles

Applicable Specifications

EN 854-2TE

Hose Construction

- Tube:** Synthetic rubber
Reinforcement: Two layers of textile braid
Cover: Flame retardent synthetic rubber

Recommended Fluids

Petroleum based hydraulic fluids, water-glycol and water-oil emulsion hydraulic fluids, grease, lubricants, crude and fuel oils, air and water.

Consult the chemical compatibility section on page Ab-16 for more detailed information.

Temperature Range -40 °C up to +100 °C

Exception: Air max. 70 °C
 Water max. 85 °C

Fittings series

Available as complete hose assembly*



XXXX-XX-XX Part Number	Hose I.D.				Hose O.D.	Pressure rating				min. bend radius mm	Weight kg/m
	DN	Inch	Size	mm	mm	max. dynamic working pressure		min. burst pressure			
						MPa	psi	MPa	psi		
681DB-4	6	1/4	-4	6,3	13,1	7,5	1090	30,0	4360	40	0,15
681DB-5	8	5/16	-5	7,9	14,6	6,8	980	27,0	3920	50	0,16
681DB-6	10	3/8	-6	9,5	16,2	6,3	910	25,0	3640	60	0,19
681DB-8	12	1/2	-8	12,7	19,9	5,8	840	23,0	3360	70	0,24
681DB-10	16	5/8	-10	15,9	23,4	5,0	725	20,0	2900	90	0,35
681DB-12	20	3/4	-12	19,1	26,5	4,5	650	18,0	2600	110	0,39
681DB-16	25	1	-16	25,4	33,4	4,0	580	16,0	2320	150	0,59











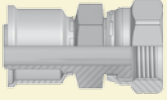











The combination of high temperature and high pressure could reduce the hose life.













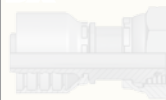







* Compatible with Parker 2 piece fittings for use with adjustable crimpers only (47 series nipple and 10064 series shell) – see catalogue 4481

Information about standard products or non-standard products can be found in the current price list. Dimensions shown may be changed at any time without prior notice.

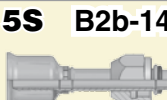
Fittings Overview 26 Series

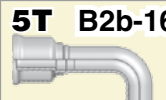
DIN	CA B2b-1  DKOL	CE B2b-2  DKOL 45°	CF B2b-3  DKOL 90°	D0  CEL	C0  DKM or DKLL	C3  DKL	C4  DKL 45°	
	C5  DKL 90°	1D  BEL	DD  BEL 45°	5D  BEL 90°	C9  DKOS	0C  DKOS 45°	1C  DKOS 90°	
	D2  CES	C6  DKS	3D  BES	49 B2b-19  Metric Banjo	9B  Swivel Female 45° Elbow	9C  Swivel Female 90° Elbow		
	92 B2b-4  DKR	B1 B2b-5  DKR 45°	B2 B2b-6  DKR 90°	B4  DKR 90° (Compact)	EA  DKOR	EB  DKOR 45°	EC  DKOR 90°	
	D9  AGR	91 B2b-7  AGR-K	B5  Female BSP Parallel Pipe - Swivel (Flat Seat)	34  Standpipe				
	01 B2b-8  AGN	02  Female NPTF Pipe Rigid - Straight	03  AGJ	04  Male SAE 45° - Rigid	05  Male SAE Straight Thread with O-ring - Rigid	06 B2b-9 68  DKJ	08 B2b-12  AGS	
13  Male NPTF Pipe Swivel	33  Male JIC 37° - Rigid	37 B2b-10 3V  DKJ 45°	39 B2b-11 3W  DKJ 90°	41 3Y  DKJ 90°L	L9  DKJ 90° M	93  Female JIC 37° - Swivel (Block Type)		
15 4A  SFL	16  SFL 22.5°	17 4F  SFL 45°	19 4N  SFL 90°	6A  SFS	6F  SFS 45°	6N  SFS 90°		
89  SFL 90° - long	XA  Caterpillar Flange Head	XF  Caterpillar Flange Head 45°	XG  Caterpillar Flange Head 60°	XN  Caterpillar Flange Head 90°				

ORFS	JC B2b-13  ORFS - short	JS  ORFS - long	J7  ORFS 45°	J9  ORFS Female 90°	J1  ORFS 90° - extra long	J5  ORFS 90° - long	JM  ORFS Male
	JD  Male ORFS – Bulkhead with Locknut (with O-ring)						
JIS	FU  GU	GU  GUO	MU  Female Metric Swivel – (30° Flare)	MZ  Female Metric Swivel – (30° Flare)	UT  Male BSP Taper Pipe Rigid – (60° Cone)		
	French Standard	FG  Male Rigid Gas Series - (24° Cone)	F2  Female Swivel Gas Series	F4  Female Swivel Gas Series - (Ball Nose)	F6  Male Metric (24° Cone)	F9  Swivel Female Metric (Ball Nose)	FA  Metric Male for Agriculture Valves
High Pressure Cleaning		CW  Power Cleaner Connection	PW  Male Kärcher Metric Cleaning Hose Fitting – Rigid	NW  Female Kärcher Metric Cleaning Hose Fitting – (New Design)			

others	XU  Female Metric Swivel – (30° Flare)	XY  Female Metric Swivel – (30° Flare)	DK  Male Metric L – Rigid Bulkhead with Locknut (24° Cone)	DX  Female Metric Swivel (M27x2) O-ring – Light Series	FF  Metru-Lok Swivel Female	AF  Male BSP Parallel Pipe Rigid – Straight (with O-ring Seal)	NM  Male BSP Parallel Pipe – L Series – Rigid Straight – ED-Seal
	YW  Male Standpipe – Rigid – Straight – A-Lok	VW121  BSP Swivel Female	82  Push-Lok Union	DP  Metric Swivel Female Tee / Male Stud	DR  Metric Swivel Female Tee	5C  60° Cone Swivel Female	6C  60° Cone Swivel Female – 45° Elbow
	7C  60° Cone Swivel Female – 90° Elbow	5S B2b-14  Female Tube O-ring Swivel – Short Pilot	5H B2b-15  Female Tube O-ring Swivel – 45° Elbow Short Pilot	5T B2b-16  Female Tube O-ring Swivel 90° Elbow Short Pilot	59PT B2b-17  Male Tube O-ring Swivel – Long Pilot Charge Port at 180° for R134a	5LPT B2b-18  Female Tube O-ring Swivel – 90° Elbow Long Pilot Charge Port at 180° for R134a	T1 B2b-20  Male Refrigerant Tube Mender – Straight (with Nut and Ferrule)

CA – Female Metric 24° – Light Series with O-ring – Swivel – Straight

ISO 12151-2-SWS – DKOL

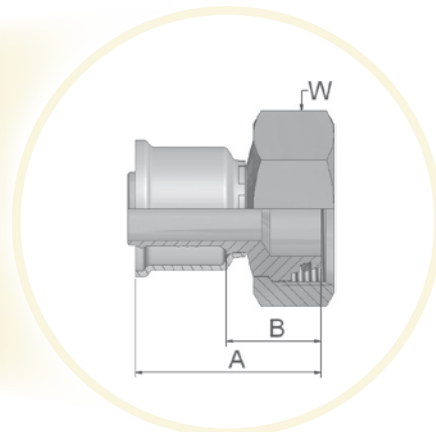
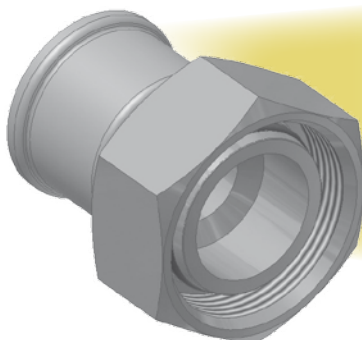

Approved fitting series for hose types:



XXXX-XX-XX Part Number  26	Hose I.D.			Thread metric	Tube O.D.	A	B	W
	Inch	Size	mm					
1CA26-6-4	3/16	-4	5,0	M12x1,5	6	41	20	14
1CA26-8-4	3/16	-4	5,0	M14x1,5	8	41	20	17
1CA26-10-5	1/4	-5	6,3	M16x1,5	10	41	20	19
1CA26-10-6	5/16	-6	8,0	M16x1,5	10	40	20	19
1CA26-12-6	5/16	-6	8,0	M18x1,5	12	40	21	22
1CA26-12-8	13/32	-8	10,0	M18x1,5	12	41	21	22
1CA26-15-8	13/32	-8	10,0	M22x1,5	15	42	21	27
1CA26-18-10	1/2	-10	12,5	M26x1,5	18	46	23	32
1CA26-18-12	5/8	-12	16,0	M26x1,5	18	46	24	32
1CA26-22-12	5/8	-12	16,0	M30x2	22	48	26	36
1CA26-28-16	7/8	-16	22,0	M36x2	28	54	28	41
1CA26-35-16	7/8	-16	22,0	M45x2	35	55	28	50
1CA26-28-20	1-1/8	-20	29,0	M36x2	28	60	34	41
1CA26-35-20	1-1/8	-20	29,0	M45x2	35	56	29	50
1CA26-35-24	1-3/8	-24	35,0	M45x2	35	62	34	50
1CA26-42-24	1-3/8	-24	35,0	M52x2	42	59	31	60

Material: steel chromium(VI) free plated

Hose fittings are delivered with ozone resistant Nitrile (NBR) O-ring as a standard version. Working temperature from -30 °C up to +105 °C. Hose fittings with special O-rings (Viton or EPDM) available on request. For O-ring dimensions and part-numbers see Section Eb.

Information about standard products or non-standard products can be found in the current price list. Dimensions shown may be changed at any time without prior notice.

CE – Female Metric 24° – Light Series with O-ring – Swivel – 45° Elbow

ISO 12151-2-SWE45 – DKOL 45°

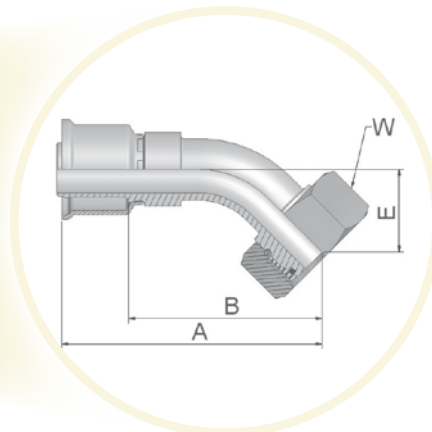
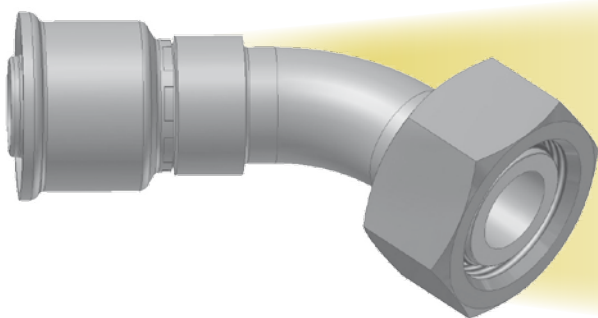

Approved fitting series for hose types:



XXXX-XX-XX Part Number 26	Hose I.D.			Thread metric	Tube O.D.	A	B	E	W
	Inch	Size	mm						
1CE26-10-6	5/16	-6	8,0	M16x1,5	10	66	45	18	19
1CE26-12-6	5/16	-6	8,0	M18x1,5	12	66	46	18	22
1CE26-12-8	13/32	-8	10,0	M18x1,5	12	59	39	17	22
1CE26-15-8	13/32	-8	10,0	M22x1,5	15	60	35	17	27
1CE26-18-10	1/2	-10	12,5	M26x1,5	18	69	46	21	32
1CE26-18-12	5/8	-12	16,0	M26x1,5	18	73	50	22	32
1CE26-22-12	5/8	-12	16,0	M30x2	22	77	55	26	36
1CE26-28-16	7/8	-16	22,0	M36x2	28	103	76	33	41
1CE26-35-16	7/8	-16	22,0	M45x2	35	104	75	33	50
1CE26-35-20	1-1/8	-20	29,0	M45x2	35	119	92	36	50
1CE26-35-24	1-3/8	-24	35,0	M45x2	35	128	100	38	50

Material: steel chromium(VI) free plated

Hose fittings are delivered with ozone resistant Nitrile (NBR) O-ring as a standard version. Working temperature from -30 °C up to +105 °C.

Hose fittings with special O-rings (Viton or EPDM) available on request. For O-ring dimensions and part-numbers see Section Eb.

Information about standard products or non-standard products can be found in the current price list. Dimensions shown may be changed at any time without prior notice.

CF – Female Metric 24° – Light Series with O-ring – Swivel – 90° Elbow

ISO 12151-2-SWE90 – DKOL 90°

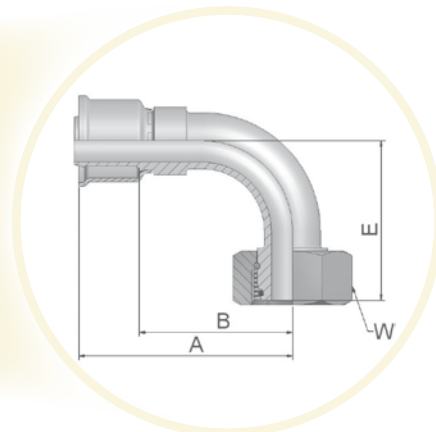
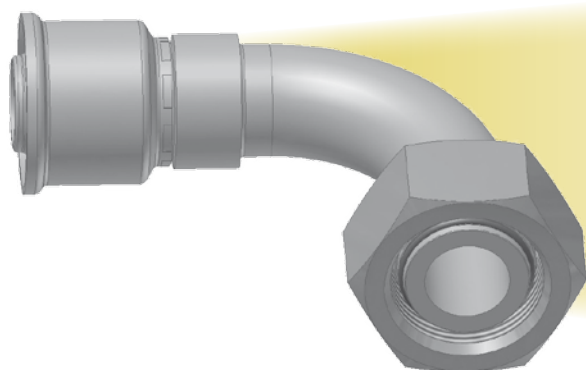

Approved fitting series for hose types:



XXXX-XX-XX Part Number 	Hose I.D.			Thread metric	Tube O.D.	A	B	E	W
	Inch	Size	mm						
1CF26-8-4	3/16	-4	5,0	M14x1,5	8	45	24	29	17
1CF26-10-5	1/4	-5	6,3	M16x1,5	10	55	36	29	19
1CF26-10-6	5/16	-6	8,0	M16x1,5	10	53	33	35	19
1CF26-12-6	5/16	-6	8,0	M18x1,5	12	56	35	36	22
1CF26-12-8	13/32	-8	10,0	M18x1,5	12	51	30	31	22
1CF26-15-8	13/32	-8	10,0	M22x1,5	15	58	38	41	27
1CF26-12-10	1/2	-10	12,5	M18x1,5	12	57	34	40	22
1CF26-18-10	1/2	-10	12,5	M26x1,5	18	57	34	38	32
1CF26-18-12	5/8	-12	16,0	M26x1,5	18	57	34	38	32
1CF26-22-12	5/8	-12	16,0	M30x2	22	78	55	47	36
1CF26-18-16	7/8	-16	22,0	M26x1,5	18	92	65	70	32
1CF26-28-16	7/8	-16	22,0	M36x2	28	95	68	71	41
1CF26-28-20	1-1/8	-20	29,0	M36x2	28	117	90	81	41
1CF26-35-20	1-1/8	-20	29,0	M45x2	35	117	90	77	50
1CF26-35-24	1-3/8	-24	35,0	M45x2	35	117	89	79	50
1CF26-42-24	1-3/8	-24	35,0	M52x2	42	117	89	76	60

Material: steel chromium(VI) free plated

Hose fittings are delivered with ozone resistant Nitrile (NBR) O-ring as a standard version. Working temperature from -30 °C up to +105 °C. Hose fittings with special O-rings (Viton or EPDM) available on request. For O-ring dimensions and part-numbers see Section Eb.

Information about standard products or non-standard products can be found in the current price list. Dimensions shown may be changed at any time without prior notice.

92 – Female BSP Parallel Pipe – Swivel – Straight (60° Cone)

BS5200-A – DKR

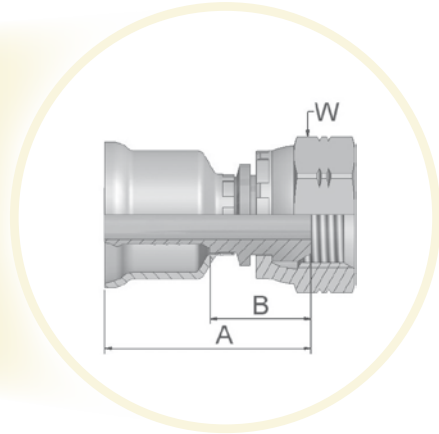
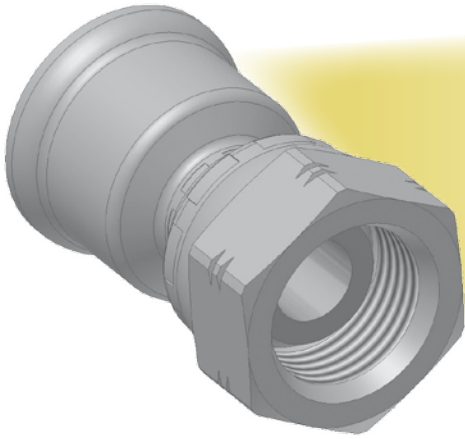

Approved fitting series for hose types:



XXXX-XX-XX Part Number 	Hose I.D.			Thread BSP	A	B	W
	Inch	Size	mm				
19226-4-4	3/16	-4	5,0	1/4x19	41	20	19
19226-6-6	5/16	-6	8,0	3/8x19	41	21	22
19226-6-8	13/32	-8	10,0	3/8x19	42	21	22
19226-8-8	13/32	-8	10,0	1/2x14	44	23	27
19226-8-10	1/2	-10	12,5	1/2x14	45	22	27
19226-10-10	1/2	-10	12,5	5/8x14	45	22	30
19226-12-12	5/8	-12	16,0	3/4x14	45	24	32
19226-16-16	7/8	-16	22,0	1x11	52	25	41
19226-20-20	1-1/8	-20	29,0	1-1/4x11	58	31	50
19226-20-24	1-3/8	-24	35	1-1/4x11	59	31	50
19226-32-32	1-13/16	-32	46	2	68	36	70

Material: steel chromium(VI) free plated

Information about standard products or non-standard products can be found in the current price list. Dimensions shown may be changed at any time without prior notice.

B1 - Female BSP Parallel Pipe – Swivel – 45° Elbow (60° Cone)

BS 5200-D – DKR 45°

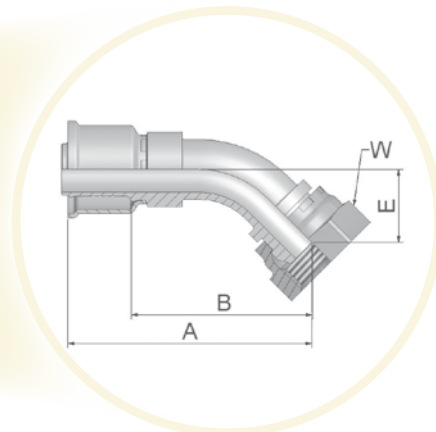
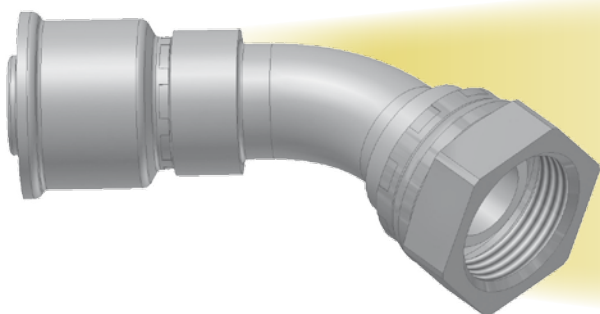

Approved fitting series for hose types:



XXXX-XX-XX Part Number 	Hose I.D.			Thread BSP	A	B	E	W
	Inch	Size	mm					
1B126-4-4	3/16	-4	5,0	1/4x19	44	24	26	19
1B126-6-6	5/16	-6	8,0	3/8x19	55	36	16	22
1B126-8-8	13/32	-8	10,0	1/2x14	62	42	16	27
1B126-10-10	1/2	-10	12,5	5/8x14	67	44	20	30
1B126-12-12	5/8	-12	16,0	3/4x14	70	47	18	32
1B126-16-16	7/8	-16	22,0	1x11	103	76	31	41
1B126-20-20	1-1/8	-20	29,0	1-1/4x11	125	98	35	50

Material: steel chromium(VI) free plated

Information about standard products or non-standard products can be found in the current price list.
Dimensions shown may be changed at any time without prior notice.

B2 – Female BSP Parallel Pipe – Swivel – 90° Elbow (60° Cone)

BS 5200-B – DKR 90°

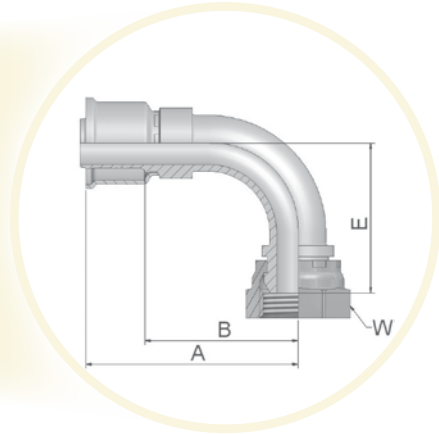
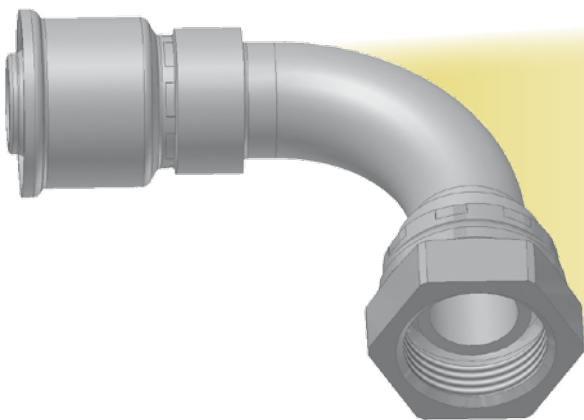

Approved fitting series for hose types:



XXXX-XX-XX Part Number 	Hose I.D.			Thread BSP	A	B	E	W
	Inch	Size	mm					
1B226-4-4	3/16	-4	5,0	1/4x19	54	33	15	19
1B226-6-6	5/16	-6	8,0	3/8x19	47	26	29	22
1B226-8-8	13/32	-8	10,0	1/2x14	54	34	31	27
1B226-10-10	1/2	-10	12,5	5/8x14	69	47	44	30
1B226-12-12	5/8	-12	16,0	3/4x14	62	40	37	32
1B226-16-16	7/8	-16	22,0	1x11	96	69	67	41
1B226-20-20	1-1/8	-20	29,0	1-1/4x11	117	90	76	50

Material: steel chromium(VI) free plated

Information about standard products or non-standard products can be found in the current price list. Dimensions shown may be changed at any time without prior notice.

91 – Male BSP Taper Pipe – Rigid – Straight

BS5200 – AGR-K

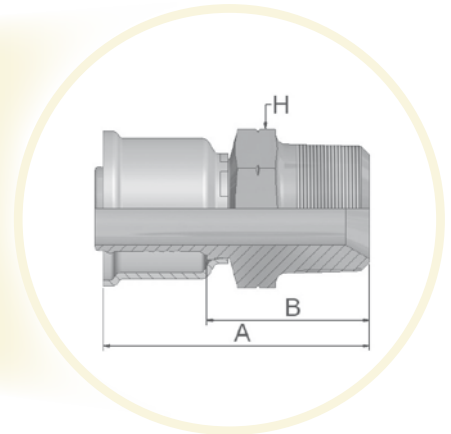
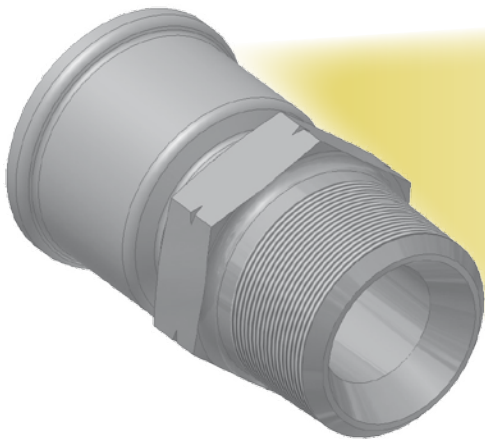

Approved fitting series for hose types:



XXXX-XX-XX Part Number  26	Hose I.D.			Thread BSP	A mm	B mm	H mm
	Inch	Size	mm				
19126-6-6	5/16	-6	8,0	3/8x19	47	27	17
19126-8-8	13/32	-8	10,0	1/2x14	53	32	22
19126-12-12	5/8	-12	16,0	3/4x14	58	36	27
19126-16-16	7/8	-16	22,0	1x11	69	43	36
19126-20-20	1-1/8	-20	29,0	1-1/4x11	72	45	46
19126-20-24	1-3/8	-24	35	1-1/4x11	72	45	46
19126-32-32	1-13/16	-32	46	2	91	59	65

Material: steel chromium(VI) free plated

Information about standard products or non-standard products can be found in the current price list.
Dimensions shown may be changed at any time without prior notice.



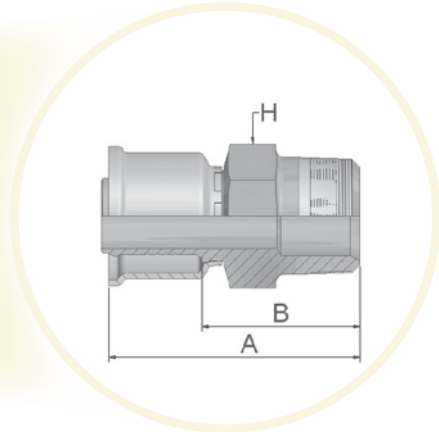
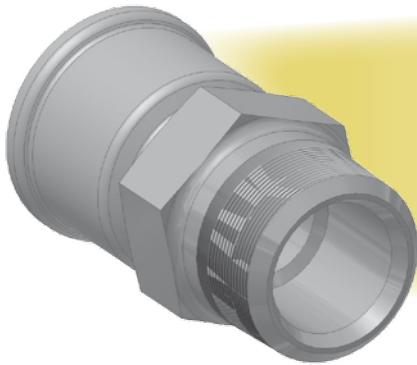

01 – Male NPTF Pipe – Rigid – Straight

SAE J476A – J516



Approved fitting series for hose types:

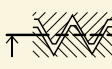

XXXX-XX-XX Part Number 	 Hose I.D.			 Thread NPTF	A mm	B mm	 H Inch
	Inch	Size	mm				
10126-4-4	3/16	-4	5,0	1/4x18	48	26	9/16
10126-4-5	1/4	-5	6,3	1/4x18	48	26	9/16
10126-4-6	5/16	-6	8,0	1/4x18	48	26	3/4
10126-6-6	5/16	-6	8,0	3/8x18	48	26	11/16
10126-6-8	13/32	-8	10,0	3/8x18	48	26	11/16
10126-8-8	13/32	-8	10,0	1/2x14	54	33	7/8
10126-8-10	1/2	-10	12,5	1/2x14	57	33	7/8
10126-12-12	5/8	-12	16,0	3/4x14	59	35	1-1/16
10126-16-16	7/8	-16	22,0	1x11-1/2	66	40	1-3/8
10126-20-20	1-1/8	-20	29,0	1-1/4x11-1/2	72	45	1-3/4
10126-24-24	1-3/8	-24	35,0	1-1/2x11-1/2	76	49	2
10126-32-32	1-13/16	-32	46,0	2x11-1/2	87	55	2-1/2

Material: steel chromium(VI) free plated

Information about standard products or non-standard products can be found in the current price list. Dimensions shown may be changed at any time without prior notice.



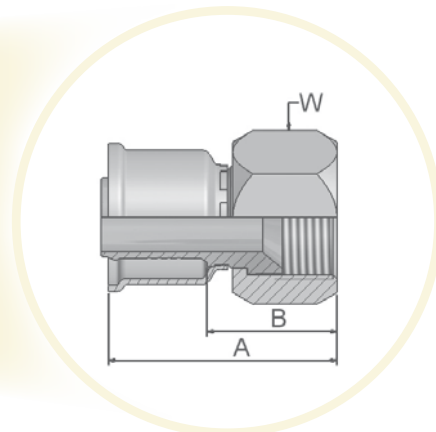
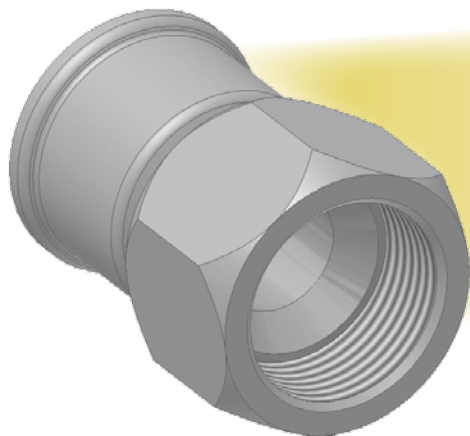

06/68 – Female – JIC 37° / SAE 45° Dual Flare – Swivel – Straight

ISO12151-5-SWS – DKJ



Approved fitting series for hose types:

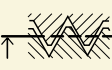

XXXX-XX-XX Part Number 	 Hose I.D.			 Thread UNF	Tube size	A	B	 W
	Inch	Size	mm					
16826-4-4-SM	3/16	-4	5,0	7/16x20	1/4	43	24	14
16826-4-4	3/16	-4	5,0	7/16x20	1/4	42	20	9/16
16826-4-5	1/4	-5	6,3	7/16x20	1/4	48	26	9/16
16826-5-5-SM	1/4	-5	6,3	1/2x20	5/16	44	23	17
16826-5-5BA	1/4	-5	6,3	1/2x20	5/16	45	23	5/8
10626-6-6-SM	5/16	-6	8,0	9/16x18	3/8	45	24	19
10626-6-6	5/16	-6	8,0	9/16x18	3/8	45	23	11/16
16826-8-8-SM	13/32	-8	10,0	3/4x16	1/2	48	27	22
10826-8-8	13/32	-8	10,0	3/4x16	1/2	49	27	7/8
16826-8-8BS	13/32	-8	10,0	3/4x16	1/2	49	27	7/8
16826-8-10	1/2	-10	12,5	3/4x16	1/2	60	36	7/8
16826-10-10-SM	1/2	-10	12,5	7/8x14	5/8	41	19	27
16826-10-10BA	1/2	-10	12,5	7/8x14	5/8	55	31	1
16826-10-12-SM	5/8	-12	16,0	7/8x14	5/8	61	33	27
16826-10-12	5/8	-12	16,0	7/8x14	5/8	61	37	1
10626-12-12-SM	5/8	-12	16,0	1-1/16x12	3/4	56	34	32
10626-12-12	5/8	-12	16,0	1-1/16x12	3/4	58	34	1-1/4
10626-16-16-SM	7/8	-16	22,0	1-5/16x12	1	62	36	41
10626-16-16	7/8	-16	22,0	1-5/16x12	1	64	38	1-1/2
10626-20-20-SM	1-1/8	-20	29,0	1-5/8x12	1-1/4	67	40	50
10626-20-24-SM	1-3/8	-24	35,0	1-5/8x12	1-1/4	80	52	50
10626-24-24-SM	1-3/8	-24	35,0	1-7/8x12	1-1/2	72	44	60
10626-32-32	1-13/16	-32	46,0	2-1/2x12	2	84	52	2-7/8

Material: steel chromium(VI) free plated
 BA: Nipple: Brass, Nut and Shell: Steel
 BS: Nipple and Nut: Brass, Shell: Steel
 SM: Metric Hexagon

Information about standard products or non-standard products can be found in the current price list.
 Dimensions shown may be changed at any time without prior notice.

37/3V – Female JIC 37° /SAE 45° – Dual Flare – Swivel Female 45° Elbow

ISO 12151-5-SWE45 – DKJ 45°

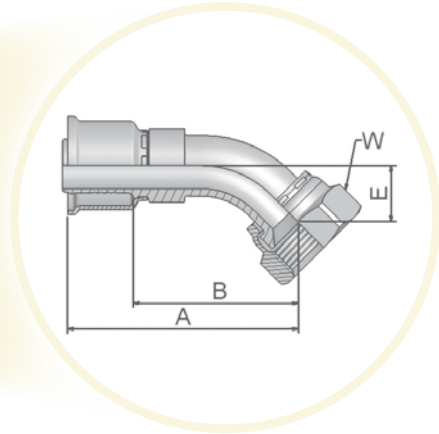
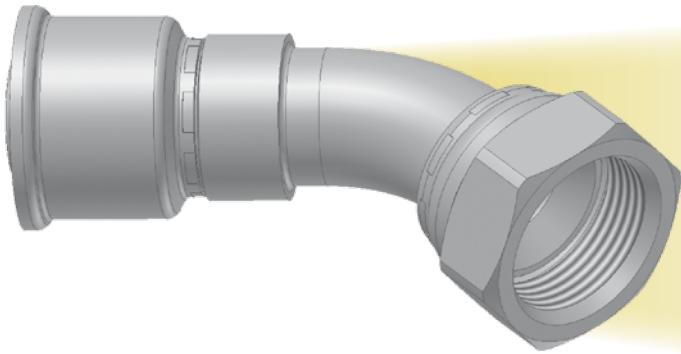

Approved fitting series for hose types:



XXXX-XX-XX Part Number 26	Hose I.D.			Thread UNF	Tube size Inch	A mm	B mm	E mm	W Inch
	Inch	Size	mm						
13V26-4-4-SM	3/16	-4	5,0	7/16x20	1/4	50	24	10	14
13726-6-6-SM	5/16	-6	8,0	9/16x18	3/8	54	33	11	19
13V26-8-8-SM	13/32	-8	10,0	3/4x16	1/2	59	38	15	22
13V26-10-10	1/2	-10	12,5	7/8x14	5/8	69	44	17	1
13726-12-12-SM	5/8	-12	16,0	1-1/16x12	3/4	75	53	20	32
13726-16-16-SM	7/8	-16	22,0	1-5/16x12	1	102	76	24	41

Material: steel chromium(VI) free plated
SM: Metric Hexagon

Information about standard products or non-standard products can be found in the current price list.
Dimensions shown may be changed at any time without prior notice.

39/3W – Female JIC 37° / SAE 45° – Dual Flare – Swivel Female 90° Elbow

ISO 12151-5-SWES – DKJ 90°

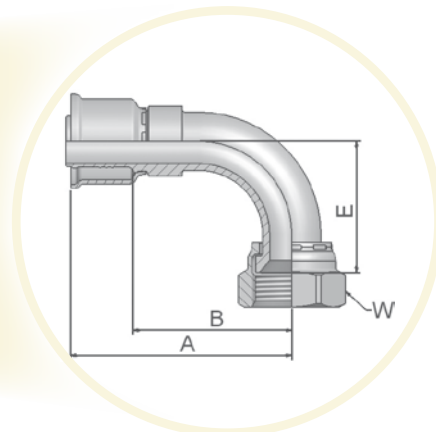
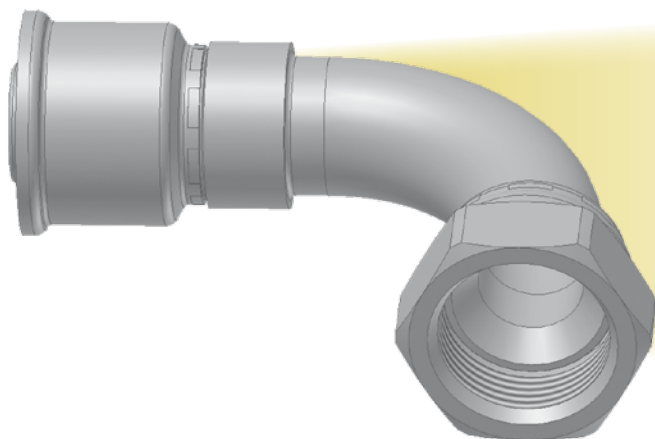

Approved fitting series for hose types:



XXXX-XX-XX Part Number 	Hose I.D.			Thread UNF	Tube size	A	B	E	W
	Inch	Size	mm						
13W26-4-4-SM	3/16	-4	5,0	7/16x20	1/4	45	20	21	14
13W26-5-5-SM	1/4	-5	6,3	1/2x20	5/16	50	30	20	17
13926-6-6-SM	5/16	-6	8,0	9/16x18	3/8	49	29	22	19
13926-6-6	5/16	-6	8,0	9/16x18	3/8	51	28	22	11/16
13W26-8-6-SM	5/16	-6	8,0	3/4x16	3/8	52	32	29	22
13W26-8-8-SM	13/32	-8	10,0	3/4x16	1/2	53	32	29	22
13W26-8-8	13/32	-8	10,0	3/4x16	1/2	54	32	29	7/8
13W26-8-10-SM	1/2	-10	12,5	3/4x16	5/8	56	34	29	22
13W26-10-10-SM	1/2	-10	12,5	7/8x14	5/8	60	38	32	27
13W26-10-10	1/2	-10	12,5	7/8x14	5/8	65	41	31	1
13W26-10-12-SM	5/8	-12	16,0	7/8x14	5/8	63	41	33	27
13926-12-12-SM	5/8	-12	16,0	1-1/16x12	3/4	73	51	46	32
13926-12-12	5/8	-12	16,0	1-1/16x12	3/4	74	51	46	1-1/4
13926-16-16-SM	7/8	-16	22,0	1-5/16x12	1	102	75	59	41
13926-20-20-SM	1-1/8	-20	29,0	1-5/8x12	1-1/4	108	81	70	50

Material: steel chromium(VI) free plated
SM: Metric Hexagon

Information about standard products or non-standard products can be found in the current price list.
Dimensions shown may be changed at any time without prior notice.



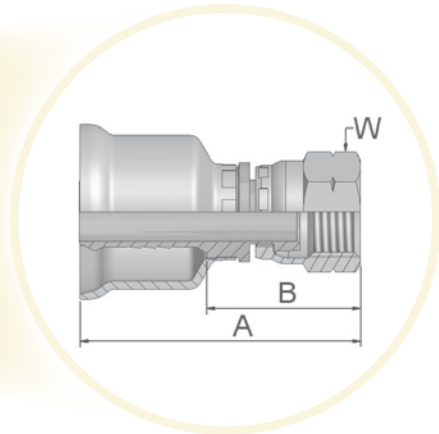
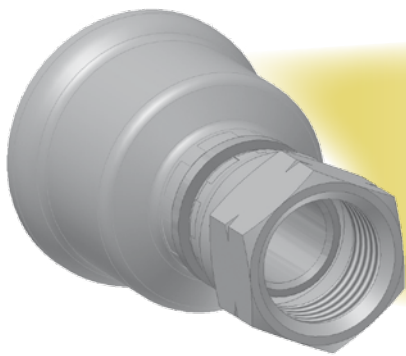

08 – Female SAE 45° – Swivel – Straight

SAE J516



Approved fitting series for hose types:

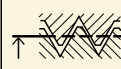

XXXX-XX-XX Part Number 	 Hose I.D.			 Thread UNF	Tube O.D.	A	B	 W
	Inch	Size	mm		mm	mm	mm	Inch
10826-6-6	5/16	-6	8,0	5/8x18	3/8	47	25	3/4
10826-6-6BA	5/16	-6	8,0	5/8x18	3/8	47	25	3/4
10826-12-12	5/8	-12	16,0	1-1/16x14	3/4	56	32	1-1/4

Material: steel chromium(VI) free plated
 BA: Nipple: Brass, Nut and Shell: Steel

Information about standard products or non-standard products can be found in the current price list.
 Dimensions shown may be changed at any time without prior notice.

JC – Female ORFS – Swivel – Straight – Short

ISO 12151-1-SWSA – SAE J516 – ORFS

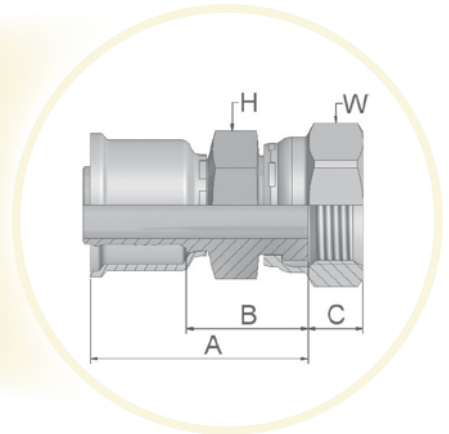
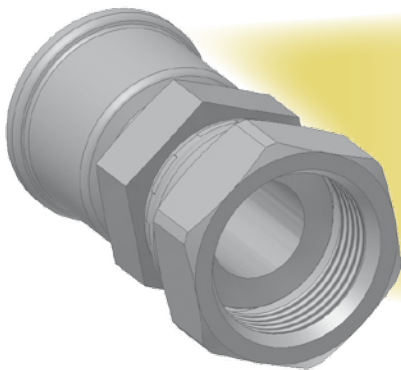

Approved fitting series for hose types:



XXXX-XX-XX Part Number  26	Hose I.D.			Thread UNF	A mm	B mm	C mm	H Inch	W Inch
	Inch	Size	mm						
1JC26-4-4-SM	3/16	-4	5,0	9/16x18	42	20	8	14	17
1JC26-6-6-SM	5/16	-6	8,0	11/16x16	43	21	9	17	22
1JC26-8-6-SM	5/16	-6	8,0	13/16x16	42	23	11	19	24
1JC26-8-8-SM	13/32	-8	10,0	13/16x16	45	23	11	22	24
1JC26-8-10-SM	1/2	-10	12,5	13/16x16	46	23	11	22	24
1JC26-10-10-SM	1/2	-10	12,5	1x14	51	27	12	24	30
1JC26-10-12-SM	5/8	-12	16,0	1x14	49	27	12	24	30
1JC26-12-12-SM	5/8	-12	16,0	1-3/16x12	43	21	14		36
1JC26-16-16-SM	7/8	-16	22,0	1-7/16x12	61	34	14	36	41
1JC26-20-20-SM	1-1/8	-20	29,0	1-11/16x12	62	35	15	50	50
1JC26-24-24-SM	1-3/8	-24	35,0	2x12	63	35	16	60	60

Material: steel chromium(VI) free plated
SM: Metric Hexagon



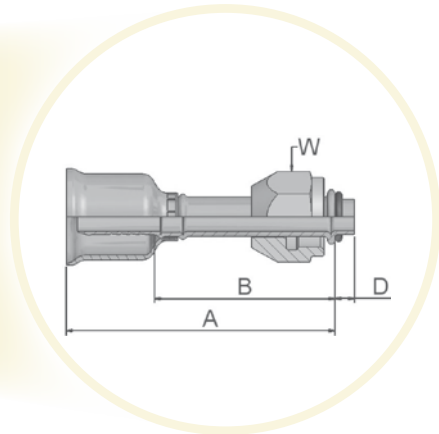
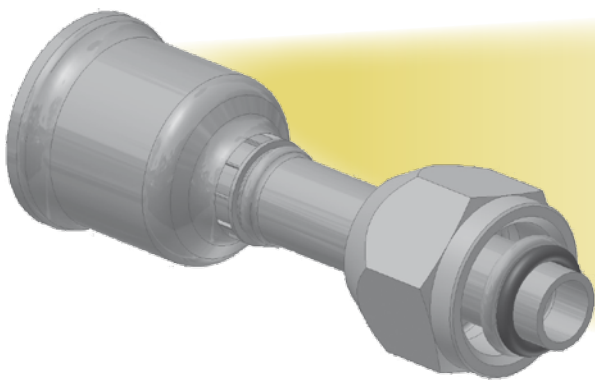

Information about standard products or non-standard products can be found in the current price list.
Dimensions shown may be changed at any time without prior notice.

5S – Female Tube O-ring Swivel – Short Pilot



Approved fitting series for hose types:

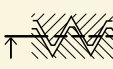

XXXX-XX-XX Part Number 	 Hose I.D.			 Thread UNF	A mm	B mm	D mm	 W Inch
	Inch	Size	mm					
15S26-6-6	5/16	-6	8,0	5/8x18	66	44	4,7	3/4
15S26-8-8	13/32	-8	10,0	3/4x16	67	45	4,7	7/8
15S26-10-10	1/2	-10	12,5	7/8x14	71	47	4,7	1-1/16
15S26-10-12	5/8	-12	16,0	7/8x14	71	47	4,7	1-1/16

Material: steel chromium(VI) free plated

Information about standard products or non-standard products can be found in the current price list. Dimensions shown may be changed at any time without prior notice.

5H – Female Tube O-ring Swivel – 45° Elbow – Short Pilot

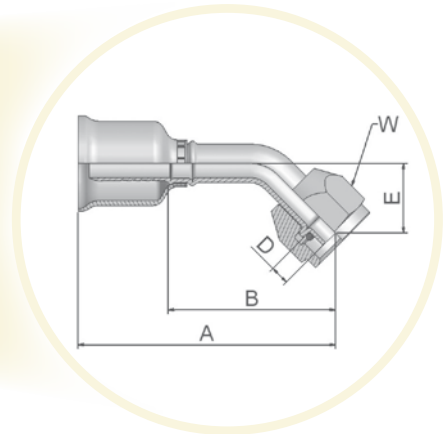
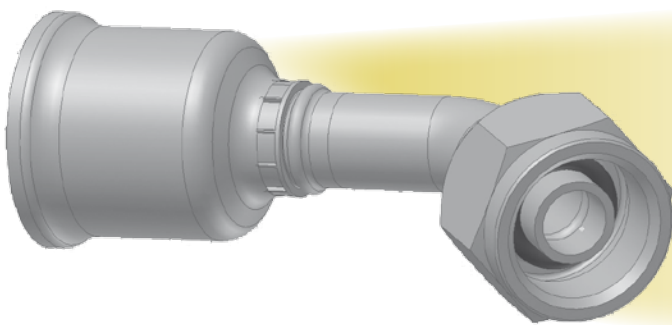

Approved fitting series for hose types:



XXXX-XX-XX Part Number 	Hose I.D.			Thread UNF	A mm	B mm	D mm	E mm	W Inch
	Inch	Size	mm						
15H26-6-6	5/16	-6	8,0	5/8x18	61	39	4,7	14	3/4
15H26-8-8	13/32	-8	10,0	3/4x16	65	43	4,7	15	7/8
15H26-10-10	1/2	-10	12,5	7/8x14	77	53	4,7	17	1-1/16
15H26-10-12	5/8	-12	16,0	7/8x14	77	53	4,7	17	1-1/16

Material: steel chromium(VI) free plated

Information about standard products or non-standard products can be found in the current price list.
Dimensions shown may be changed at any time without prior notice.

5T - Female Tube O-ring Swivel - 90° Elbow - Short Pilot

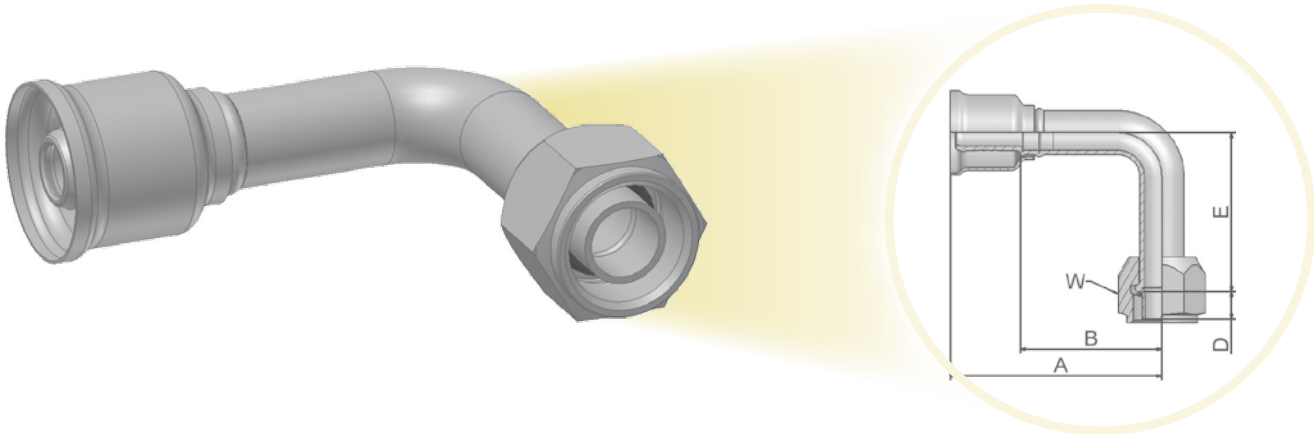

Approved fitting series for hose types:



XXXX-XX-XX Part Number 26	Hose I.D.			Thread UNF	A	B	D	E	W
	Inch	Size	mm						
15T26-6-6	5/16	-6	8,0	5/8x18	56	34	4,7	36	3/4
15T26-8-8	13/32	-8	10,0	3/4x16	63	41	4,7	37	7/8
15T26-10-10	1/2	-10	12,5	7/8x14	73	49	4,7	44	1-1/16
15T26-10-12	5/8	-12	16,0	7/8x14	73	50	4,7	44	1-1/16

Material: steel chromium(VI) free plated

Information about standard products or non-standard products can be found in the current price list. Dimensions shown may be changed at any time without prior notice.

59PT – Male Tube O-ring Swivel – Long Pilot

with Charge Port at 180° for R134a

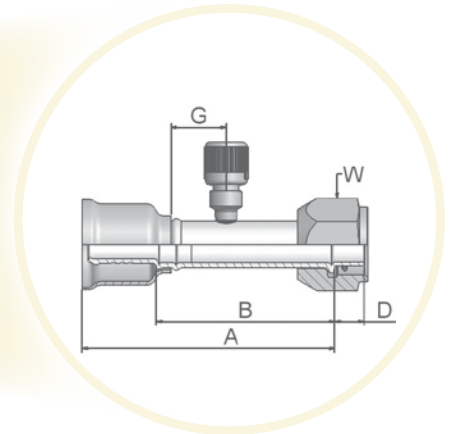
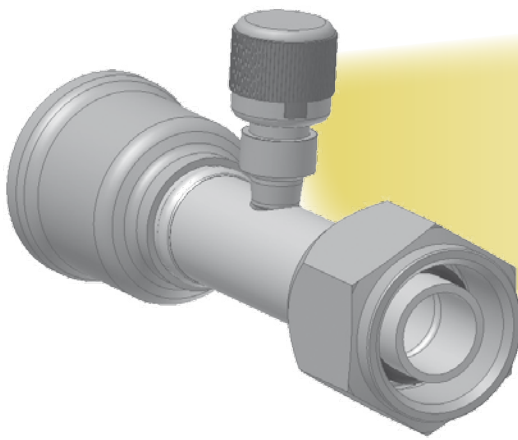

Approved fitting series for hose types:



XXXX-XX-XX Part Number 	Hose I.D.			Thread UNF	A mm	B mm	D mm	G mm	W Inch
	Inch	Size	mm						
15926-6-6-PT	5/16	-6	8,0	5/8x18	83	61	7,1	13	3/4
15926-8-8-PT	13/32	-8	10,0	3/4x16	74	52	9,8	13	7/8
15926-10-12-PT	5/8	-12	16,0	7/8x14	88	65	9,8	15	1-1/16

Material: steel chromium(VI) free plated

Information about standard products or non-standard products can be found in the current price list. Dimensions shown may be changed at any time without prior notice.



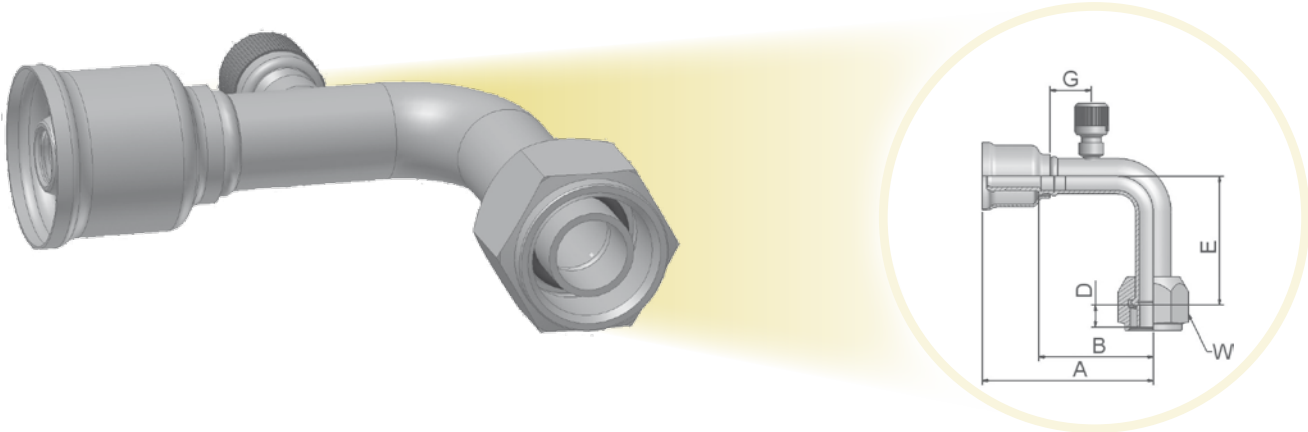

5LPT – Female Tube O-ring Swivel – 90° Elbow – Long Pilot

with Charge Port at 180° for R134a



Approved fitting series for hose types:



XXXX-XX-XX Part Number 	 Hose I.D.			 Thread UNF	A	B	D	E	G	 W
	Inch	Size	mm		mm	mm	mm	mm	mm	Inch
15L26-6-6-PT	5/16	-6	8,0	5/8x18	77	56	7.1	36	13	3/4
15L26-8-8-PT	13/32	-8	10,0	3/4x16	82	60	9.8	37	15	7/8
15L26-10-10-PT	1/2	-10	12,5	7/8x14	91	67	9.8	57	15	1-1/16
15L26-10-12-PT	5/8	-12	16,0	7/8x14	91	67	9.8	57	15	1-1/16

Material: steel chromium(VI) free plated

Information about standard products or non-standard products can be found in the current price list. Dimensions shown may be changed at any time without prior notice.

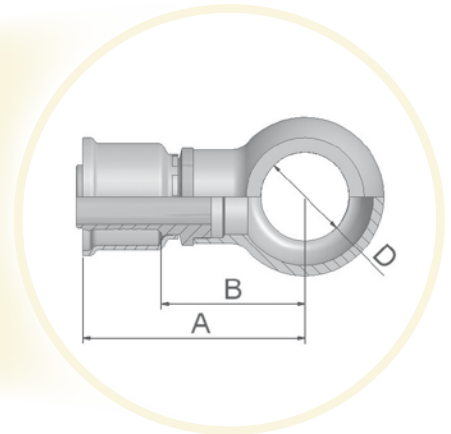
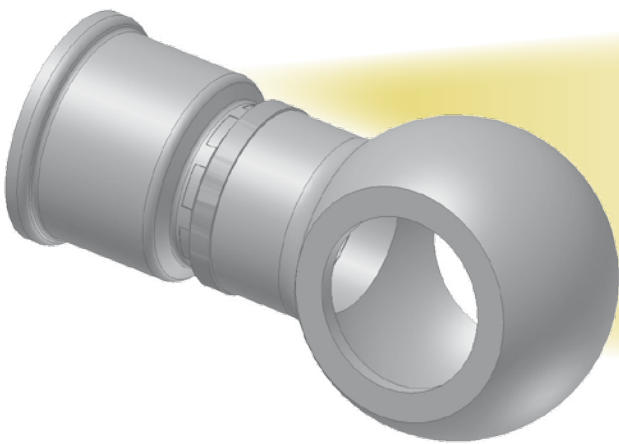

49 – Metric Banjo – Straight

DIN 7642



Approved fitting series for hose types:



XXXX-XX-XX Part Number 	 Hose I.D.			D mm	A mm	B mm
	Inch	Size	mm			
14926-12-6	5/16	-6	8,0	12	47	26
14926-14-6	5/16	-6	8,0	14	49	28
14926-14-8	13/32	-8	10,0	14	48	28
14926-16-8	13/32	-8	10,0	16	50	30
14926-33,4-20	1-1/8	-20	29,0	33	75	48

Material: steel chromium(VI) free plated

Information about standard products or non-standard products can be found in the current price list.
Dimensions shown may be changed at any time without prior notice.

T1 – Male Refrigerant Tube Mender – Straight (with Nut and Ferrule)

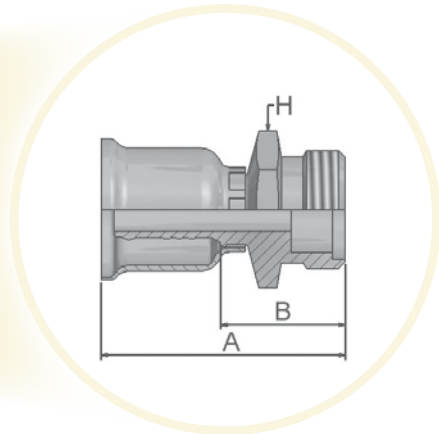
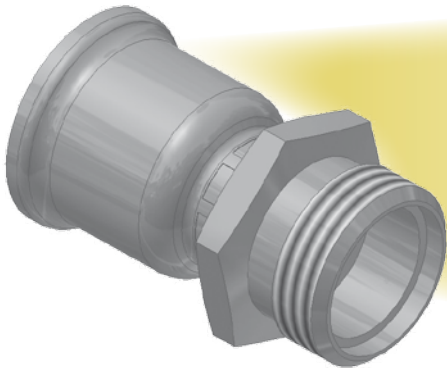

Approved fitting series for hose types:



XXXX-XX-XX Part Number  26	Hose I.D.			Thread UNF	A mm	B mm	H Inch
	Inch	Size	mm				
1T126-6-6	5/16	-6	8,0	3/8	50	28	11/16
1T126-8-8	13/32	-8	10,0	1/2	53	31	13/16
1T126-10-10	1/2	-10	12,5	5/8	58	34	15/16
1T126-10-12	5/8	-12	16,0	5/8	58	34	15/16
1T126-12-12	5/8	-12	16,0	3/4	59	35	1-1/8

1T126 Fitting Installation Instructions

1. Cut the tube off squarely next to the hose fitting. At least 7/8" (22 mm) straight length is required and the outside diameter of the tube should be smooth and free from deep lengthwise scratches.
2. To prevent cutting the inside of the O-ring, smoothly chamfer the outside of the cut end 15° to 30°. Deburr the inside diameter.
3. Remove the nut, compression sleeve, and O-ring from the fitting and lubricate the O-ring with a lubricant that is compatible with the refrigerant used in the system.
4. Place the lubricated O-ring in the counterbore of the fitting.
5. Slip the compression sleeve, small end, into the nut and assemble the nut on the fitting fingertight. Make sure the compression sleeve is not cocked in the nut. Back the nut off 1/16 to 1/3 turn (one to two hex flats).
6. Insert the chamfered tube end through the nut into the fitting. If high resistance is felt when the end of the tube contacts the O-ring, remove the tube. The end of the tube may require a larger chamfer and/or the O-ring may require more lubrication on the inside diameter. Repeat the previous steps.
7. (a) Make sure the tube is bottomed in the fitting,
(b) tighten the nut finger tight,
(c) mark the fitting and nut hex indicating the starting point (see illustration) and
(d) Hand tighten the nut.
Mark the nipple and the nut so the starting position can be noted
8. Later, if it is ever necessary to loosen the connection, re-assemble the nut 1/6 turn (one hex flat) after finger tight.

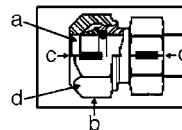

Information about standard products or non-standard products can be found in the current price list. Dimensions shown may be changed at any time without prior notice.



aerospace
climate control
electromechanical
filtration
fluid & gas handling
hydraulics
pneumatics
process control
sealing & shielding



Hydraulic Hose, Fittings and Equipment

Medium Pressure



ENGINEERING YOUR SUCCESS.

Medium Pressure Hose and Fittings

- the perfect range for the more demanding market requirements



The medium pressure hose range contains the new *Elite No-Skive* compact hydraulic hoses exceeding ISO and EN specifications, and the classical *No-Skive* hydraulic hoses according to ISO, EN and SAE specifications. This hose range is complemented by a full selection of compatible *No-Skive* fittings in steel and stainless steel.

- ▶ Extended range of working temperatures:
Low (down to -50 °C) and
High (up to +150 °C)
- ▶ Selected hoses feature nitrile inner tubes suitable for mineral and bio-degradable oils
- ▶ Full range of fluid compatibility; oil, water, phosphate ester etc.
- ▶ Using high quality compounds allows thin covers – less weight – long service life still assured
- ▶ High flexibility for easier installation and increased service life
- ▶ Small bend radii and light weight for applications where space and weight are determining factors
- ▶ High abrasion resistance hose covers superior to ISO 6945 requirements, extending service life
- ▶ High ozone-resistant cover compounds extending weathering / aging resistance
- ▶ Parkrimp machines, portable or bench mounted for easy assembly operation – hose assemblies meet CE directives
- ▶ Complete *No-Skive* fitting technology across the full range of medium pressure hoses providing simpler, quicker and safer hose assembly



Parkrimp® *No-Skive*

The system for fast and leak-free assemblies

- No skiving tool needed
- No need to remove the cover
- Crimps one piece fittings
- Parkalign positions the fittings in the die perfectly every time
- Quick and easy: no gauges to set on the machine
- Portable machines for field repair
- Meets EN safety regulations

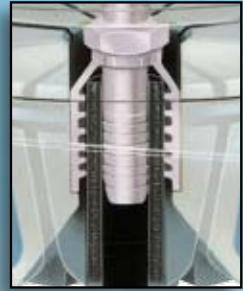

Parkalign®
Parker's exclusive Parkalign® positions the fitting in the dies perfectly every time.

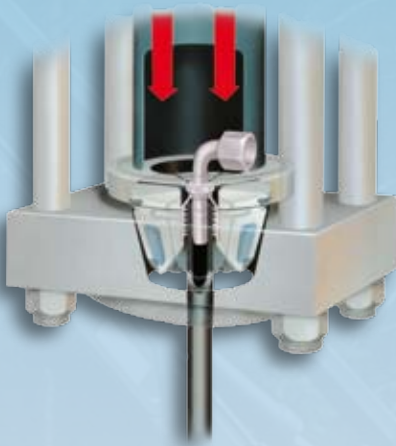

Parker's colour-coded die sets

No loose parts to mismatch or misplace – die set segments linked together. Die sets provide 360° evenly applied crimping forces for an ideal crimp result.

The perfect match

The complete system from one source. *No-Skive* hose, *No-Skive* fitting and crimping machine with world-wide guarantee and availability.



The definitive hose range for all medium pressure applications



Index

301SN	– <i>No-Skive</i> - EN 853-2SN Hose	Ca-1
302	– WORLDWIDE <i>No-Skive</i> Hose	Ca-2
304	– <i>No-Skive</i> - 2 Wire Phosphate Ester Resistant Hose . .	Ca-3
402	– <i>Elite</i> Compact Pilot Line Hose	Ca-4
421RH	– <i>No-Skive</i> - Fire-retardant Cover	Ca-5
421SN	– <i>No-Skive</i> - EN 853-1SN Hose	Ca-6
421WC	– <i>No-Skive</i> - SAE 100 R1 AT Wire Covered Hose	Ca-7
422	– WORLDWIDE <i>No-Skive</i> Hose	Ca-8
424	– <i>No-Skive</i> - 1 Wire Phosphate Ester Resistant Hose . .	Ca-9
426	– <i>No-Skive</i> - High Temperature 1 Wire Hose	Ca-10
436	– <i>No-Skive</i> - High Temperature 2 Wire Hose	Ca-11
441	– <i>No-Skive</i> - Compact 1 Wire Hi-pac Construction Hose	Ca-12
441RH	– <i>No-Skive</i> - Compact - Fire-retardant Cover	Ca-13
451TC	– <i>No-Skive</i> - SAE 100 R17 TOUGH COVER Hose	Ca-14
461LT	– <i>Elite</i> Compact Low Temperature EN 857-2SC Hose.	Ca-15
462	– <i>Elite</i> Compact EN 857-2SC Hose	Ca-16
462ST	– <i>Elite</i> Compact EN 857-2SC SUPER TOUGH Hose	Ca-17
463	– <i>No-Skive</i> Compact 2 Wire Hot Water Cleaning Hose	Ca-18
471TC	– <i>No-Skive</i> Compact EN 857-2SC TOUGH COVER Hose . .	Ca-19
472TC	– <i>No-Skive</i> Compact EN 857-2SC TOUGH COVER Hose . .	Ca-19
492	– <i>Elite</i> Compact EN 857-1SC Hose	Ca-20
492ST	– <i>Elite</i> Compact EN 857-1SC SUPER TOUGH Hose	Ca-21
493	– <i>No-Skive</i> Compact 1 Wire Hot Water Cleaning Hose	Ca-22
692	– <i>Elite</i> Compact Hose	Ca-23
692Twin	– <i>Elite</i> Compact Vulcanised Twin Hose	Ca-24
811	– <i>No-Skive</i> Suction and Return Line Hose	Ca-25
881	– <i>No-Skive</i> Suction and Return Line Hose	Ca-26
Crimp Fittings: 46 and 48 Series		Cb-1–Cb-72

301SN – No-Skive Hose

EN 853 2SN – ISO 1436 Type 2

Main Features

- *No-Skive* thin cover hose construction
- Nitrile (NBR) inner tube
– extended fluid compatibility
- Suitable with 48 series fittings
- Type approved with DNV, GL, LR, RINA

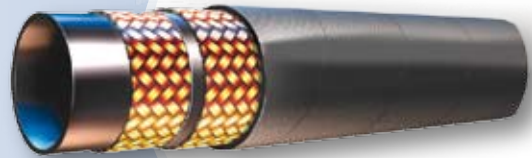

Primary Applications/Restrictions

General medium pressure hydraulic applications

Applicable Specifications

EN 853 2SN – ISO 1436 Type 2 – SAE 100 R2 AT

Hose Construction

Tube: Nitrile (NBR)
Reinforcement: Two high tensile steel wire braids
Cover: Synthetic rubber

Recommended Fluids

Petroleum and water-glycol based fluids, lubricating oils, air and water. For air above 1,7 MPa, the hose cover must be pin-pricked.

Consult the chemical compatibility section on page Ab-16 for more detailed information.

Temperature Range –40 °C up to +100 °C

Exception: Air.....max. +70 °C
 Water.....max. +85 °C

Fittings Series



XXXX-XX-XX Part Number	Hose I.D.				Hose O.D.	Pressure rating				min. bend radius mm	Weight kg/m
	DN	Inch	Size	mm	mm	max. dynamic working pressure		min. burst pressure			
						MPa	psi	MPa	psi		
301SN-4	6	1/4	-4	6,3	15,0	40,0	5800	160,0	23200	100	0,39
301SN-5	8	5/16	-5	7,9	16,6	35,0	5075	140,0	20300	115	0,42
301SN-6	10	3/8	-6	9,5	19,0	33,0	4775	132,0	19100	130	0,55
301SN-8	12	1/2	-8	12,7	22,2	27,5	4000	110,0	16000	180	0,67
301SN-10	16	5/8	-10	15,9	25,4	25,0	3600	100,0	14500	200	0,77
301SN-12	20	3/4	-12	19,1	29,3	21,5	3100	86,0	12400	240	1,00
301SN-16	25	1	-16	25,4	38,1	16,5	2400	66,0	9600	300	1,49
301SN-20	32	1-1/4	-20	31,8	47,5	12,5	1800	50,0	7200	420	1,73
301SN-24	40	1-1/2	-24	38,1	55,0	9,0	1300	36,0	5200	500	2,14
301SN-32	50	2	-32	50,8	67,0	8,0	1150	32,0	4600	630	2,96

The combination of high temperature and high pressure could reduce the hose life.

Information about standard products or non-standard products can be found in the current price list. Dimensions shown may be changed at any time without prior notice.

302 – WORLDWIDE *No-Skive* Hose

EN 853 2SN – ISO S 1436

Main Features

- Meets ISO 1436
- Worldwide availability
- Worldwide consistent appearance, partnumber and functionality
- *No-Skive* thin cover hose construction
- Extended fluid compatibility (including biodegradable oils)

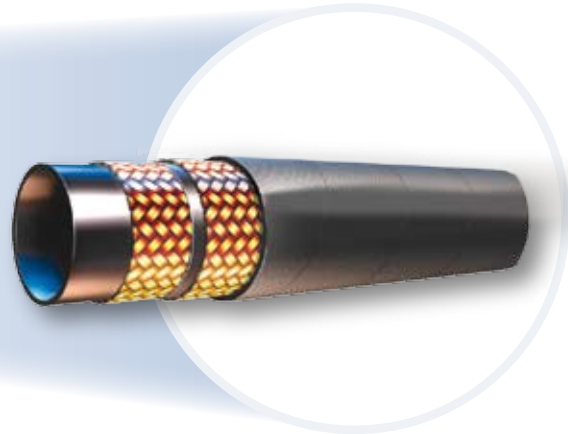

Primary Applications/Restrictions

General medium pressure hydraulic applications

Applicable Specifications

EN 853 2SN – ISO S 1436 – SAE 100 R2 AT

Hose Construction

Tube: Nitrile (NBR)
Reinforcement: Two high tensile steel wire braids
Cover: Synthetic rubber

Recommended Fluids

Petroleum and water-glycol based fluids, lubricating oils, air and water. For air above 1,7 MPa, the hose cover must be pin-pricked. Consult the chemical compatibility section on page Ab-16 in catalogue 4400 for more detailed information.

Consult the chemical compatibility section on page Ab-16 for more detailed information.

Temperature Range -40 °C up to +100 °C

Exception: Air.....max. +70 °C
 Water.....max. +85 °C

Fittings Series



XXXX-XX-XX Part Number	Hose I.D.				Hose O.D.	Pressure rating				min. bend radius mm	Weight kg/m
	DN	Inch	Size	mm	mm	max. dynamic working pressure		min. burst pressure			
						MPa	psi	MPa	psi		
302-4	6	1/4	-4	6,3	15,0	40,0	5800	160,0	23200	100	0,39
302-5	8	5/16	-5	7,9	16,6	35,0	5075	140,0	20300	115	0,42
302-6	10	3/8	-6	9,5	19,0	33,0	4775	132,0	19100	130	0,55
302-8	12	1/2	-8	12,7	22,2	27,5	4000	110,0	16000	180	0,67
302-10	16	5/8	-10	15,9	25,4	25,0	3600	100,0	14500	200	0,77
302-12	20	3/4	-12	19,1	29,3	21,5	3100	86,0	12400	240	1,00
302-16	25	1	-16	25,4	38,1	16,5	2400	66,0	9600	300	1,49
302-20	32	1-1/4	-20	31,8	47,5	12,5	1800	50,0	7200	420	1,73
302-24	40	1-1/2	-24	38,1	55,0	9,0	1300	36,0	5200	500	2,14
302-32	50	2	-32	50,8	67,0	8,0	1150	32,0	4600	630	2,96

The combination of high temperature and high pressure could reduce the hose life.

Information about standard products or non-standard products can be found in the current price list. Dimensions shown may be changed at any time without prior notice.

304 – No-Skive Hose

Phosphate ester resistant hose

Main Features

- *No-Skive* thin cover hose construction
- EPDM hose resistant to phosphate ester fluids
- SAE 100R2 pressure rating

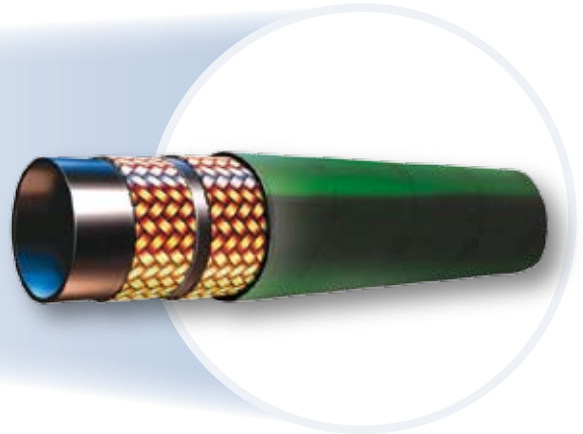

Primary Applications/Restrictions

Aerospace, foundries, steel mills:
Medium pressure hydraulic applications with phosphate ester fluids
Do not use with petroleum based fluids

Applicable Specifications

Parker specification

Hose Construction

Tube: EPDM synthetic rubber
Reinforcement: Two high tensile steel wire braids
Cover: Green EPDM synthetic rubber

Recommended Fluids

Phosphate ester base hydraulic fluids, water-glycol based fluids, air and water.
Consult the chemical compatibility section on page Ab-16 for more detailed information.

Temperature Range

-40 °C up to +80 °C
Exception: Air max. +70 °C
Water and water glycol fluids .. max. +85 °C

Fittings Series

Parker 43 series*
Parker 48 series for sizes -20 to -32

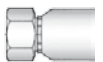

XXXX-XX-XX Part Number	Hose I.D.				Hose O.D.	Pressure rating				min. bend radius mm	Weight kg/m
						max. dynamic working pressure		min. burst pressure			
	DN	Inch	Size	mm	mm	MPa	psi	MPa	psi		
304-4	6	1/4	-4	6,3	15,0	34,5	5000	138,0	20000	100	0,39
304-6	10	3/8	-6	9,5	19,0	27,5	4000	110,0	16000	130	0,55
304-8	12	1/2	-8	12,7	22,0	24,0	3500	96,0	14000	180	0,67
304-12	20	3/4	-12	19,1	30,0	15,5	2250	62,0	9000	240	1,00
304-16	25	1	-16	25,4	38,0	13,8	2000	55,0	8000	300	1,49
304-20	32	1-1/4	-20	31,8	48,0	11,2	1625	45,0	6500	420	1,73
304-24	40	1-1/2	-24	38,1	55,0	8,6	1250	35,0	5000	500	2,14
304-32	50	2	-32	50,8	68,0	7,8	1125	31,0	4500	630	2,96

The combination of high temperature and high pressure could reduce the hose life.
*Parker fitting series 43 is compatible with this hose type in all sizes and is available on request only.

Information about standard products or non-standard products can be found in the current price list.
Dimensions shown may be changed at any time without prior notice.

402 – Elite Compact Hose

Pilot line applications

Main Features

- *No-Skive* thin cover Compact hose
- Constant pressure hose 10,0 MPa

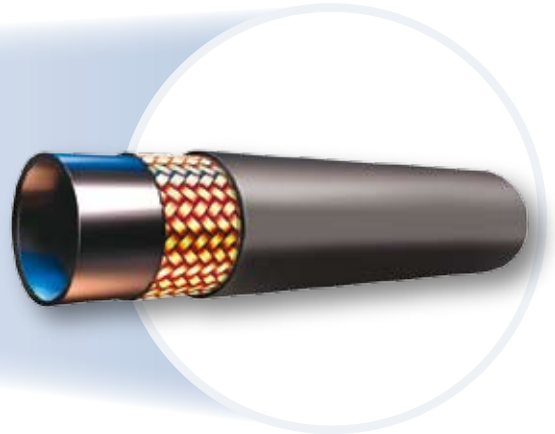

Primary Applications/Restrictions

Mobile hydraulic: Pilot lines

Hose Construction

Tube: Nitrile (NBR)
Reinforcement: One high tensile steel wire braid
Cover: Synthetic rubber

Recommended Fluids

Petroleum and water-glycol based fluids, lubricating oils, air and water. For air above 1,7 MPa, the hose cover must be pin-pricked.

Consult the chemical compatibility section on page Ab-16 for more detailed information.

Temperature Range -40 °C up to +100 °C

Exception: Air..... max. +70 °C
 Water max. +85 °C

Fittings Series

Available as complete hose assemblies



XXXX-XX-XX Part Number	Hose I.D.				Hose O.D.	Pressure rating				min. bend radius mm	Weight kg/m
	DN	Inch	Size	mm	mm	max. dynamic working pressure		min. burst pressure			
						MPa	psi	MPa	psi		
402-4	6	1/4	-4	6,3	11,6	10,0	1450	40,0	5800	50	0,15
402-5	8	5/16	-5	7,9	13,2	10,0	1450	40,0	5800	60	0,18
402-6	10	3/8	-6	9,5	14,8	10,0	1450	40,0	5800	65	0,21
402-8	12	1/2	-8	12,7	18,6	10,0	1450	40,0	5800	75	0,29

The combination of high temperature and high pressure could reduce the hose life.

*Compatible with Parker 2 piece fittings for use with adjustable crimpers only (47 series nipple and 10049 series shell)

Information about standard products or non-standard products can be found in the current price list. Dimensions shown may be changed at any time without prior notice.

421RH – *No-Skive* Hose

with fire-retardant cover

Main Features

- *No-Skive* thin cover hose construction
- Nitrile (NBR) inner tube
 - high chemical resistance
- Suitable with 48 series fittings
- Fire-retardant cover

Certifications

- German Standard: DIN 5510-2
- French Standard: NF F16-101/102 I2/F3
- British Standard: BS 6853 - Table 4

Primary Applications

General medium-pressure hydraulic and pneumatic systems as well as water and oil cooling circuits

Applicable Specifications

EN 853 1SN – ISO 1436 Typ 1 – SAE100R1AT

Hose Construction

Tube: Nitrile (NBR)
Reinforcement: One high tensile steel wire braid
Cover: Fire retardant synthetic rubber

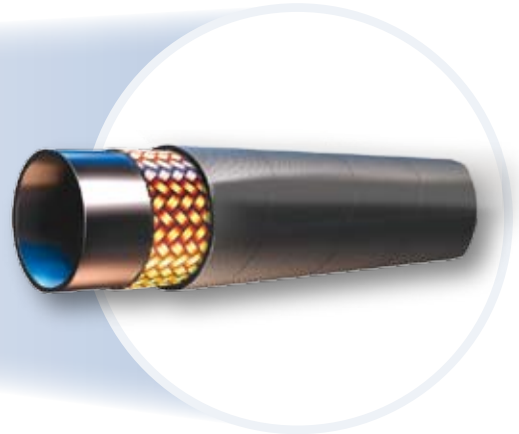

Recommended Fluids

Petroleum and water-glycol based fluids, lubricating oils, air and water. For air and gas above 1,7 MPa, the hose cover must be pin-pricked. Consult the chemical compatibility section on page Ab-16 for more detailed information.

Temperature Range

Exception: Air max. +70 °C
 Water max. +85 °C

Fitting Series



XXXX-XX-XX Part Number	Hose I.D.				Hose O.D. mm	Pressure rating				min. bend radius mm	Weight kg/m
	DN	Inch	Size	mm		max. dynamic working pressure		min. burst pressure			
						MPa	psi	MPa	psi		
421RH-20	32	1.1/4	-20	31,8	44,8	6,3	900	25,0	3600	420	1,19
421RH-24	40	1.1/2	-24	38,1	51,1	5,0	725	20,0	2900	500	1,49
421RH-32	50	2	-32	50,8	64,7	4,0	575	16,0	2300	630	2,23

The combination of high temperature and high pressure could reduce the hose life.

Information about standard products or non-standard products can be found in the current price list. Dimensions shown may be changed at any time without prior notice.

421SN – No-Skive Hose

EN 853 1SN – ISO 1436 Type 1

Main Features

- *No-Skive* thin cover hose construction
- Nitrile (NBR) inner tube
– extended fluid compatibility
- Type approved with DNV, GL, LR, RINA



Primary Applications/Restrictions

General medium pressure hydraulic applications

Applicable Specifications

EN 853 1SN – ISO 1436 Type 1 – SAE100R1AT

Hose Construction

Tube: Nitrile (NBR)
Reinforcement: One high tensile steel wire braid
Cover: Synthetic rubber

Recommended Fluids

Petroleum and water-glycol based fluids, lubricating oils, air and water. For air above 1,7 MPa, the hose cover must be pin-pricked.

Consult the chemical compatibility section on page Ab-16 for more detailed information.

Temperature Range

-40 °C up to +100 °C

Exception: Air.....max. +70 °C
 Watermax. +85 °C

Fittings Series



XXXX-XX-XX Part Number	Hose I.D.				Hose O.D.	Pressure rating				min. bend radius mm	Weight kg/m
	DN	Inch	Size	mm	mm	max. dynamic working pressure		min. burst pressure			
						MPa	psi	MPa	psi		
421SN-4	6	1/4	-4	6,3	13,4	22,5	3250	90,0	13000	100	0,24
421SN-5	8	5/16	-5	7,9	15,0	21,5	3125	86,0	12500	115	0,27
421SN-6	10	3/8	-6	9,5	17,4	18,0	2600	72,0	10400	130	0,34
421SN-8	12	1/2	-8	12,7	20,7	16,0	2325	64,0	9300	180	0,43
421SN-10	16	5/8	-10	15,9	23,9	13,0	1875	52,0	7500	200	0,49
421SN-12	20	3/4	-12	19,1	27,8	10,5	1525	42,0	6100	240	0,63
421SN-16	25	1	-16	25,4	35,8	8,8	1275	35,0	5100	300	0,94
421SN-20	32	1.1/4	-20	31,8	44,8	6,3	900	25,0	3600	420	1,19
421SN-24	40	1.1/2	-24	38,1	51,1	5,0	725	20,0	2900	500	1,49
421SN-32	50	2	-32	50,8	64,7	4,0	575	16,0	2300	630	2,23

The combination of high temperature and high pressure could reduce the hose life.

Information about standard products or non-standard products can be found in the current price list. Dimensions shown may be changed at any time without prior notice.

421WC – *No-Skive* Hose

Galvanised steel wire cover

Main Features

- *No-Skive* thin cover hose construction
- Metal and glass hot spots resistance

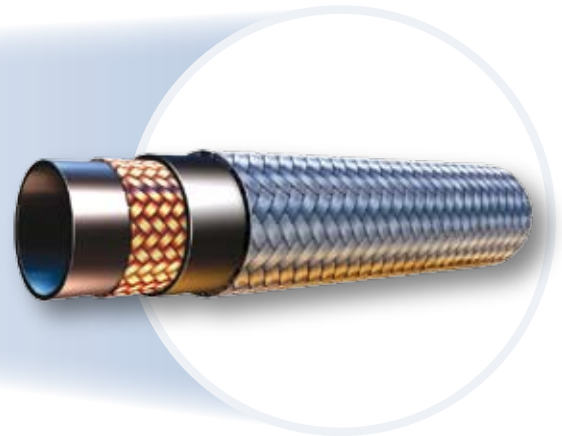

Primary Applications/Restrictions

Machine tool and glass industry

Applicable Specifications

SAE 100 R1AT

Hose Construction

Tube: Synthetic rubber
Reinforcement: One high tensile steel wire braid
Cover: Galvanized steel wire

Recommended Fluids

Petroleum and water-glycol based fluids, lubricating oils, air and water.

Consult the chemical compatibility section on page Ab-16 for more detailed information.

Temperature Range -40 °C up to +125 °C

Exception: Air..... max. +70 °C
 Water..... max. +85 °C

Fittings Series

Available as complete hose assemblies*

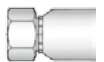

XXXX-XX-XX Part Number	Hose I.D.				Hose O.D.	Pressure rating				min. bend radius mm	Weight kg/m
	DN	Inch	Size	mm	mm	max. dynamic working pressure		min. burst pressure			
						MPa	psi	MPa	psi		
421WC-4	6	1/4	-4	6,3	15,0	19,0	2750	76,0	11000	100	0,38
421WC-6	10	3/8	-6	9,5	19,0	15,5	2250	62,0	9000	130	0,54
421WC-8	12	1/2	-8	12,7	22,0	13,8	2000	55,0	8000	180	0,67
421WC-12	20	3/4	-12	19,1	29,0	8,6	1250	35,0	5000	240	0,95
421WC-16	25	1	-16	25,4	37,0	6,9	1000	28,0	4000	300	1,31

The combination of high temperature and high pressure could reduce the hose life.
 *Parker 43 series fittings are compatible with this hose and are available only on request

Information about standard products or non-standard products can be found in the current price list.
 Dimensions shown may be changed at any time without prior notice.

422 – WORLDWIDE *No-Skive* Hose

ISO 1436 1SN

Main Features

- Meets ISO 1436
- Worldwide availability
- Worldwide consistent appearance, partnumber and functionality
- *No-Skive* thin cover hose construction
- Nitrile inner tube for greater fluid compatibility and bio-oil resistance



Primary Applications/Restrictions

General medium pressure hydraulic applications

Applicable Specifications

ISO 1436 – EN 853 1SN – SAE 100 R1 AT

Hose Construction

Tube: Nitrile (NBR)
Reinforcement: One high tensile steel wire braid
Cover: Synthetic rubber

Recommended Fluids

Petroleum and water-glycol based fluids, lubricating oils, air and water. For air above 1,7 MPa, the hose cover must be pin-pricked.

Consult the chemical compatibility section in Catalogue 4400 on page Ab-16 for more detailed information.

Temperature Range -40 °C up to +100 °C

Exception: Air.....max. +70 °C
 Watermax. +85 °C

Fittings Series



Part Number XXXX-XX-XX	Hose I.D.				Hose O.D. mm	Pressure rating				min. bend radius mm	Weight kg/m
	Hose I.D.					max. dynamic working pressure		min. burst pressure			
	DN	Inch	Size	mm		MPa	psi	MPa	psi		
422-4	6	1/4	-4	6,3	13,4	22,5	3250	90,0	13000	100	0,24
422-5	8	5/16	-5	7,9	15,0	21,5	3125	86,0	12500	115	0,27
422-6	10	3/8	-6	9,5	17,4	18,0	2600	72,0	10400	130	0,34
422-8	12	1/2	-8	12,7	20,7	16,0	2325	64,0	9300	180	0,43
422-10	16	5/8	-10	15,9	23,9	13,0	1875	52,0	7500	200	0,49
422-12	20	3/4	-12	19,0	27,8	10,5	1525	42,0	6100	240	0,63
422-16	25	1	-16	25,4	35,8	8,8	1275	35,0	5100	300	0,94
422-20	32	1.1/4	-20	31,8	44,8	6,3	900	25,0	3600	420	1,19
422-24	40	1.1/2	-24	38,1	51,1	5,0	725	20,0	2 900	500	1,49
422-32	50	2	-32	50,8	64,7	4,0	575	16,0	2 300	630	2,23

The combination of high temperature and high pressure could reduce the hose life.

Information about standard products or non-standard products can be found in the current price list. Dimensions shown may be changed at any time without prior notice.

424 – No-Skive Hose

Phosphate ester resistant hose

Main Features

- *No-Skive* thin cover hose construction
- SAE 100R1 pressure rating

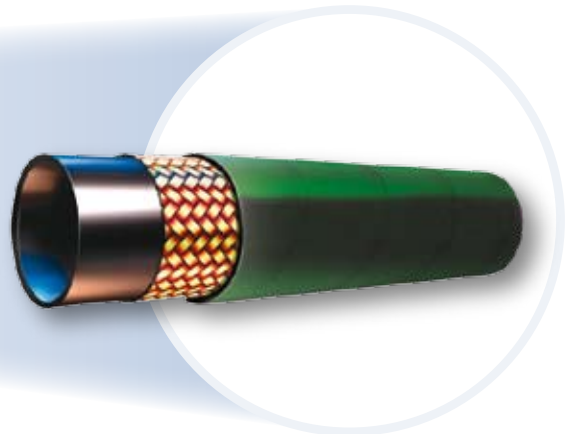

Primary Applications/Restrictions

Aerospace, foundries, steel mills:
Medium pressure hydraulic applications with phosphate ester fluids
Do not use with petroleum based fluids

Applicable Specifications

Parker specification

Hose Construction

Tube: EPDM synthetic rubber
Reinforcement: One high tensile steel wire braid
Cover: Green EPDM synthetic rubber

Recommended Fluids

Phosphate ester based hydraulic fluids, water-glycol based fluids, air and water.
Consult the chemical compatibility section on page Ab-16 for more detailed information.

Temperature Range

-40 °C up to +80 °C
Exception: Air max. +70 °C
Water and water glycol fluids... max. +85 °C

Fittings Series

Available as complete hose assemblies*



XXXX-XX-XX Part Number	Hose I.D.				Hose O.D.	Pressure rating				min. bend radius mm	Weight kg/m
						max. dynamic working pressure		min. burst pressure			
	DN	Inch	Size	mm	mm	MPa	psi	MPa	psi		
424-16	25	1	-16	25,4	36,0	6,9	1000	28,0	4000	300	0,94
424-20	32	1-1/4	-20	31,8	45,0	4,3	625	17,0	2500	420	1,19
424-24	40	1-1/2	-24	38,1	51,0	3,5	500	14,0	2000	500	1,49
424-32	50	2	-32	50,8	64,6	2,4	375	10,0	1500	630	2,23

The combination of high temperature and high pressure could reduce the hose life.
*Parker 43 series fittings are compatible with this hose and are available only on request

Information about standard products or non-standard products can be found in the current price list.
Dimensions shown may be changed at any time without prior notice.

426 – No-Skive Hose

SAE 100 R1AT high temperature

Main Features

- *No-Skive* thin cover hose construction
- SAE 100R1 pressure rating

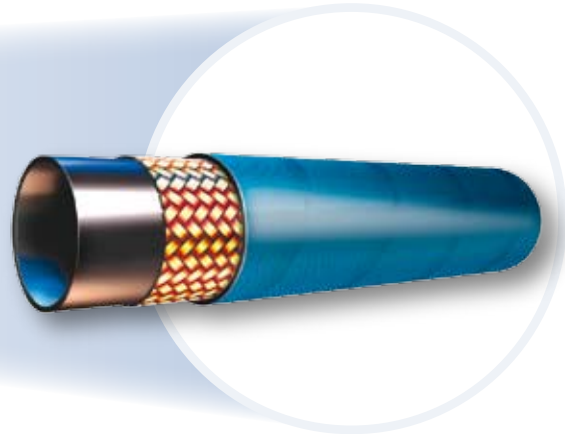

Primary Applications/Restrictions

Medium pressure hydraulic applications at high temperature

Applicable Specifications

SAE 100 R1AT

Hose Construction

Tube: PKR synthetic rubber
Reinforcement: One high tensile steel wire braid
Cover: Blue synthetic rubber

Recommended Fluids

Petroleum hydraulic fluids, lubricating oils, water-glycol based fluids, air and water.
 Consult the chemical compatibility section on page Ab-16 for more detailed information.

Temperature Range

-46 °C up to + 150 °C
 Exception: Air max. +70 °C
 Water and water glycol fluids... max. +85 °C

Fittings Series

Parker 43 series*
 Parker 48 series for sizes -8 to -16



XXXX-XX-XX Part Number	Hose I.D.				Hose O.D. mm	Pressure rating				min. bend radius mm	Weight kg/m
	DN	Inch	Size	mm		max. dynamic working pressure		min. burst pressure			
						MPa	psi	MPa	psi		
426-4	6	1/4	-4	6,3	13,4	19,2	2750	77,0	11000	100	0,24
426-6	10	3/8	-6	9,5	17,4	15,7	2250	63,0	9000	125	0,34
426-8	12	1/2	-8	12,7	20,7	14,0	2000	56,0	8000	180	0,43
426-10	16	5/8	-10	15,9	23,9	10,5	1500	42,0	6000	200	0,49
426-12	20	3/4	-12	19,1	27,8	8,7	1250	35,0	5000	240	0,65
426-16	25	1	-16	25,4	35,8	7,0	1000	28,0	4000	300	0,98

The combination of high temperature and high pressure could reduce the hose life.
 *Parker fitting series 43 is compatible with this hose type in all sizes and is available on request only.

Information about standard products or non-standard products can be found in the current price list.
 Dimensions shown may be changed at any time without prior notice.

436 – *No-Skive* Compact Hose

SAE 100R16 high temperature

Main Features

- *No-Skive* thin cover hose construction
- Compact hose construction with tight bending radius

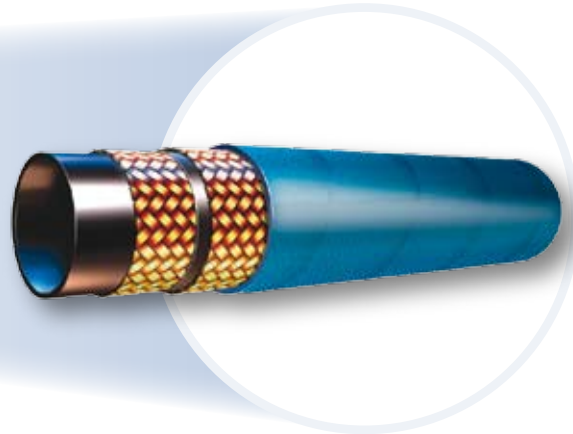

Primary Applications/Restrictions

Medium pressure hydraulic applications at high temperature

Applicable Specifications

SAE 100 R16

Hose Construction

- Tube:** PKR synthetic rubber
Reinforcement: Two high tensile steel wire braids
Cover: Blue synthetic rubber

Recommended Fluids

Petroleum hydraulic fluids, lubricating oils, water-glycol based fluids, air and water.

Consult the chemical compatibility section on page Ab-16 for more detailed information.

Temperature Range

-48 °C up to + 150 °C

Exception: Air max. +70 °C
 Water and water glycol fluids... max. +85 °C

Fittings Series



XXXX-XX-XX Part Number	Hose I.D.				Hose O.D.	Pressure rating				min. bend radius mm	Weight kg/m
						max. dynamic working pressure		min. burst pressure			
	DN	Inch	Size	mm	mm	MPa	psi	MPa	psi		
436-6-BLU-RL	10	3/8	-6	9,5	17,0	27,5	4000	110,0	16000	65	0,42
436-8-BLU-RL	12	1/2	-8	12,7	20,0	24,0	3500	96,0	14000	90	0,51
436-10-BLU-RL	16	5/8	-10	15,9	24,0	19,0	2750	76,0	11000	100	0,66
436-12-BLU-RL	20	3/4	-12	19,1	28,0	15,5	2250	62,0	9000	120	0,80
436-16-BLU-RL	25	1	-16	25,4	36,0	13,8	2000	55,0	8000	150	1,22

The combination of high temperature and high pressure could reduce the hose life.

Information about standard products or non-standard products can be found in the current price list. Dimensions shown may be changed at any time without prior notice.

441 – No-Skive Hose

ISO 11237 Type R16 – SAE 100 R16

Main Features

- *No-Skive* hose construction
- One wire braid construction
– two wire braid performance
- +125 °C working temperature
- Suitable with both 46 & 48 series fittings

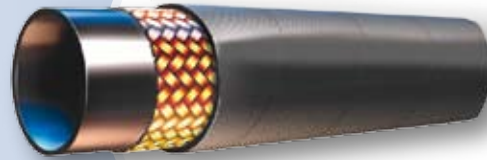

Primary Applications/Restrictions

Many industrial and mobile applications, with typical usage seen on agricultural machines or in power steering circuits

Applicable Specifications

ISO 11237 Type R16 – SAE 100 R16

Hose Construction

Tube: Synthetic rubber
Reinforcement: One steel wire Hi-Pac construction
Cover: Synthetic rubber

Recommended Fluids

Petroleum and water-glycol based fluids, lubricating oils, air and water. For air above 1,7 MPa, the hose cover must be pin-pricked.

Consult the chemical compatibility section on page Ab-16 for more detailed information.

Temperature Range –40 °C up to +125 °C

Exception: Air.....max. +70 °C
 Water.....max. +85 °C

Fittings Series



Part Number XXXX-XX-XX	Hose I.D.				Hose O.D. mm	Pressure rating				min. bend radius mm	Weight kg/m
	DN	Inch	Size	mm		max. dynamic working pressure		min. burst pressure			
						MPa	psi	MPa	psi		
441-4	6	1/4	-4	6,3	13,4	34,5	5000	138,0	20000	50	0,27
441-5	8	5/16	-5	7,9	15,0	29,3	4250	117,0	17000	55	0,32
441-6	10	3/8	-6	9,5	17,4	27,5	4000	110,0	16000	65	0,42
441-8	12	1/2	-8	12,7	20,7	24,0	3500	96,0	14000	90	0,50
441-10	16	5/8	-10	15,9	23,8	19,0	2750	76,0	11000	100	0,65
441-12	20	3/4	-12	19,1	27,8	15,5	2250	62,0	9000	120	0,80
441-16	25	1	-16	25,4	35,8	13,8	2000	55,0	8000	150	1,22

The combination of high temperature and high pressure could reduce the hose life.

Information about standard products or non-standard products can be found in the current price list. Dimensions shown may be changed at any time without prior notice.

441RH – *No-Skive* Compact Hose

with fire-retardant cover

Main Features

- *No-Skive* hose construction
- One wire braid construction
– two wire braid performance
- +125 °C working temperature
- Suitable with 46 & 48 series fittings
- Fire-retardant cover

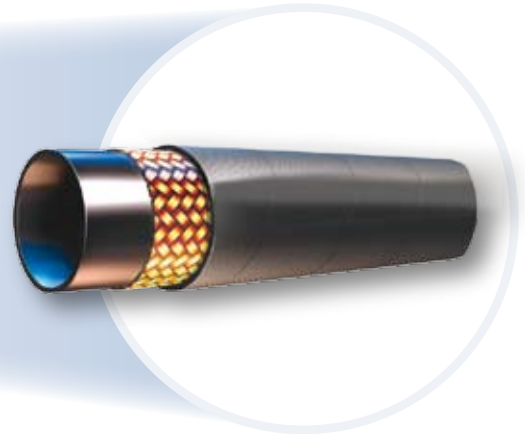

Certifications

- German Standard: DIN 5510-2
- French Standard: NF F16-101/102 I2/F3
- British Standard: BS 6853 - Table 4

Primary Applications

General medium-pressure hydraulic and pneumatic systems as well as water and oil cooling circuits

Applicable Specifications

Parker specification; Working pressure to SAE 100 R2;
Bend radius to SAE 100 R16

Hose Construction

- Tube:** Synthetic rubber
Reinforcement: One steel wire Hi-Pac construction
Cover: Fire retardant synthetic rubber

Recommended Fluids

Petroleum and water-glycol based fluids, lubricating oils, air and water. For air and gas above 1,7 MPa, the hose cover must be pin-pricked.

Consult the chemical compatibility section on page Ab-16 for more detailed information.

Temperature Range

-40 °C up to +125 °C

- Exception: Air max. +70 °C
 Water max. +85 °C

Fitting Series



XXXX-XX-XX Part Number	Hose I.D.				Hose O.D. mm	Pressure rating				min. bend radius mm	Weight kg/m
	DN	Inch	Size	mm		max. dynamic working pressure		min. burst pressure			
						MPa	psi	MPa	psi		
441RH-4	6	1/4	-4	6,3	13,4	34,5	5000	138,0	20000	50	0,27
441RH-5	8	5/16	-5	7,9	15,0	29,3	4250	117,0	17000	55	0,32
441RH-6	10	3/8	-6	9,5	17,4	27,5	4000	110,0	16000	65	0,42
441RH-8	12	1/2	-8	12,7	20,7	24,0	3500	96,0	14000	90	0,50
441RH-10	16	5/8	-10	15,9	23,8	19,0	2750	76,0	11000	100	0,65
441RH-12	20	3/4	-12	19,1	27,8	15,5	2250	62,0	9000	120	0,80
441RH-16	25	1	-16	25,4	35,8	13,8	2000	55,0	8000	150	1,22

The combination of high temperature and high pressure could reduce the hose life.

Information about standard products or non-standard products can be found in the current price list.
 Dimensions shown may be changed at any time without prior notice.

451TC – *No-Skive* Tough Cover Hose

ISO 11237 Type R17 – SAE 100 R17

Main Features

- *No-Skive* thin cover hose construction
- Tough Cover – high abrasion resistant **TOUGH COVER**
- Constant pressure hose 21,0 MPa

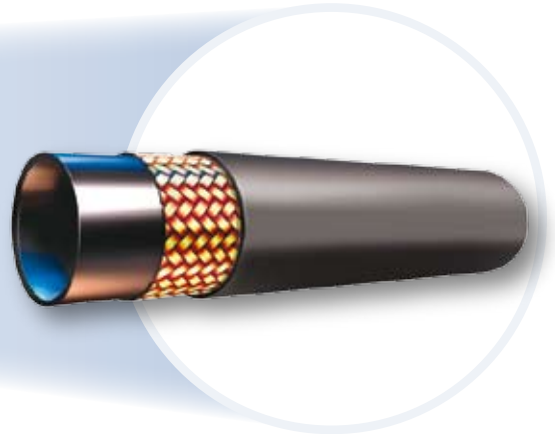

Primary Applications/Restrictions

General medium pressure hydraulic applications where higher abrasion resistance is required

Applicable Specifications

ISO 11237 Type R17 – SAE 100 R17

Hose Construction

- Tube:** Nitrile (NBR)
Reinforcement: One high tensile steel wire braid
Cover: Synthetic rubber

Recommended Fluids

Petroleum and water-glycol based fluids, lubricating oils, air and water. For air above 1,7 MPa, the hose cover must be pin-pricked.

Consult the chemical compatibility section on page Ab-16 for more detailed information.

Temperature Range

-40 °C up to +100 °C

- Exception: Air.....max. +70 °C
 Water.....max. +85 °C

Fittings Series



Part Number XXXX-XX-XX	Hose I.D.				Hose O.D. mm	Pressure rating				min. bend radius mm	Weight kg/m
	Hose I.D.					max. dynamic working pressure		min. burst pressure			
	DN	Inch	Size	mm		MPa	psi	MPa	psi		
451TC-4-RL	6	1/4	-4	6,3	13,4	21,0	3000	84,0	12000	50	0,24
451TC-6-RL	10	3/8	-6	9,5	17,2	21,0	3000	84,0	12000	65	0,34
451TC-8-RL	12	1/2	-8	12,7	20,4	21,0	3000	84,0	12000	90	0,52
451TC-10-RL	16	5/8	-10	15,9	23,8	21,0	3000	84,0	12000	100	0,66
451TC-12-RL	20	3/4	-12	19,1	27,8	21,0	3000	84,0	12000	120	0,86
451TC-16-RL	25	1	-16	25,4	35,4	21,0	3000	84,0	12000	150	1,17

The combination of high temperature and high pressure could reduce the hose life.
 RL=Delivered on reels

Information about standard products or non-standard products can be found in the current price list.
 Dimensions shown may be changed at any time without prior notice.

461LT – *Elite* Compact Hose

EN 857 2SC low temperature

Main Features

- *No-Skive* thin cover hose construction
- Excellent ozone resistance
- Ideal for low temperature working conditions (-50 °C)

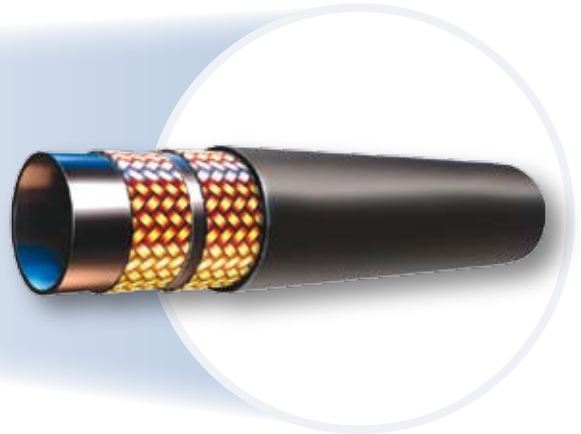

Primary Applications/Restrictions

Mobile applications in low temperature environments:

Forestry machines, refrigerated warehouses

Applicable Specifications

EN 857 2SC

Hose Construction

Tube: Synthetic rubber
Reinforcement: Two high tensile steel wire braids
Cover: Synthetic rubber

Recommended Fluids

Petroleum and water-glycol based fluids, lubricating oils, air and water. For air above 1,7 MPa, the hose cover must be pin-pricked.

Consult the chemical compatibility section on page Ab-16 for more detailed information.

Temperature Range -50 °C up to +100 °C

Exception: Air.....max. +70 °C
 Water.....max. +85 °C

Fittings Series



XXXX-XX-XX Part Number	Hose I.D.				Hose O.D.	Pressure rating				min. bend radius mm	Weight kg/m
	DN	Inch	Size	mm	mm	max. dynamic working pressure		min. burst pressure			
						MPa	psi	MPa	psi		
461LT-4	6	1/4	-4	6,3	13	42,5	6160	170,0	24640	75	0,30
461LT-5	8	5/16	-5	7,9	15	40,0	5800	160,0	23200	85	0,35
461LT-6	10	3/8	-6	9,5	17	35,0	5075	140,0	20300	90	0,42
461LT-8	12	1/2	-8	12,7	21	31,0	4495	124,0	17980	130	0,52
461LT-10	16	5/8	-10	15,9	24	28,0	4060	112,0	16240	160	0,66
461LT-12	20	3/4	-12	19,1	28	28,0	4060	112,0	16240	195	0,86
461LT-16	25	1	-16	25,4	35	21,0	3045	84,0	12180	250	1,17

The combination of high temperature and high pressure could reduce the hose life.

Information about standard products or non-standard products can be found in the current price list. Dimensions shown may be changed at any time without prior notice.

462 – Elite Compact Hose

EN 857 2SC / ISO11237 Type 2SC

Main Features

- *No-Skive* hose construction – Compact design
- Nitrile (NBR) inner tube
– extended fluid compatibility
- Exceeding EN/ISO specifications for pressure, bending radius and abrasion resistance

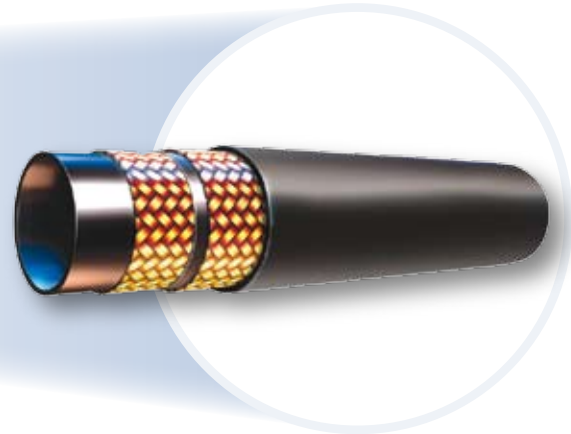

Primary Applications/Restrictions

Demanding medium pressure hydraulic applications in all markets

Applicable Specifications

EN 857 2SC / ISO11237 Type 2SC

Hose Construction

- Tube:** Nitrile (NBR)
Reinforcement: Two high tensile steel wire braids
Cover: Synthetic rubber

Recommended Fluids

Petroleum and water-glycol based fluids, lubricating oils, air and water. For air above 1,7 MPa, the hose cover must be pin-pricked.

Consult the chemical compatibility section on page Ab-16 for more detailed information.

Temperature Range

- 40 °C up to +100 °C
 Exception: Air.....max. +70 °C
 Water.....max. +85 °C

Fittings Series



Part Number	Hose I.D.				Hose O.D. mm	Pressure rating				min. bend radius mm	Weight kg/m
	DN	Inch	Size	mm		max. dynamic working pressure		min. burst pressure			
						MPa	psi	MPa	psi		
462-4	6	1/4	-4	6,3	13,4	42,5	6160	170,0	24640	75	0,30
462-5	8	5/16	-5	7,9	15,0	40,0	5800	160,0	23200	85	0,35
462-6	10	3/8	-6	9,5	17,2	35,0	5075	140,0	20300	90	0,42
462-8	12	1/2	-8	12,7	20,4	31,0	4495	124,0	17980	130	0,52
462-10	16	5/8	-10	15,9	23,9	28,0	4060	112,0	16240	160	0,66
462-12	20	3/4	-12	19,1	27,7	28,0	4060	112,0	16240	195	0,86
462-16	25	1	-16	25,4	35,4	21,0	3045	84,0	12180	250	1,17
462-4-WR	6	1/4	-4	6,3	13,4	42,5	6160	170,0	24640	75	0,30
462-5-WR	8	5/16	-5	7,9	15,0	40,0	5800	160,0	23200	85	0,35
462-6-WR	10	3/8	-6	9,5	17,2	35,0	5075	140,0	20300	90	0,42
462-8-WR	12	1/2	-8	12,7	20,4	31,0	4495	124,0	17980	130	0,52
462-10-WR	16	5/8	-10	15,9	23,9	28,0	4060	112,0	16240	160	0,66
462-12-WR	20	3/4	-12	19,1	27,7	28,0	4060	112,0	16240	195	0,86
462-16-WR	25	1	-16	25,4	35,4	21,0	3045	84,0	12180	250	1,17
462-20-WR	32	1.1/4	-20	31,8	43,0	17,2	2495	68,8	9980	335	1,50

The combination of high temperature and high pressure could reduce the hose life.

Part Number without a suffix: the hose cover has a smooth appearance.
 Part Number with a suffix (WR): the hose cover has a wrapped appearance.

Information about standard products or non-standard products can be found in the current price list.
 Dimensions shown may be changed at any time without prior notice.

462ST – *Elite* Super Tough Compact Hose

EN 857 2SC / ISO11237 Type 2SC

Main Features

- *No-Skive* hose construction – Compact design
- Nitrile (NBR) inner tube – extended fluid compatibility
- Extreme abrasion resistant **SUPER TOUGH** cover

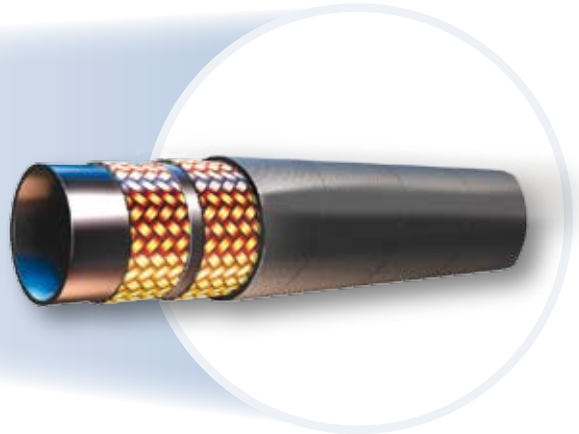

Primary Applications/Restrictions

Mobile market:

Medium pressure hydraulic applications with extremely high abrasion risks

Applicable Specifications

EN 857 2SC / ISO11237 Type 2SC

Hose Construction

Tube: Nitrile (NBR)
Reinforcement: Two high tensile steel wire braids
Cover: Synthetic rubber with a special polyethylene coating

Recommended Fluids

Petroleum and water-glycol based fluids, lubricating oils, air and water. For air above 1,7 MPa, the hose cover must be pin-pricked.

Consult the chemical compatibility section on page Ab-16 for more detailed information.

Temperature Range

-40 °C up to +100 °C

Exception: Air.....max. +70 °C
 Water.....max. +85 °C

Fittings Series



XXXX-XX-XX Part Number	Hose I.D.				Hose O.D.	Pressure rating				min. bend radius mm	Weight kg/m
						max. dynamic working pressure		min. burst pressure			
	DN	Inch	Size	mm	mm	MPa	psi	MPa	psi		
462ST-4	6	1/4	-4	6,3	13,4	42,5	6500	170,0	24600	75	0,30
462ST-5	8	5/16	-5	7,9	15,0	40,0	5800	160,0	23200	85	0,35
462ST-6	10	3/8	-6	9,5	17,2	35,0	5000	140,0	20000	90	0,42
462ST-8	12	1/2	-8	12,7	20,4	31,0	4450	124,0	17800	125	0,52
462ST-10	16	5/8	-10	15,9	23,9	28,0	4000	112,0	16000	160	0,66
462ST-12	20	3/4	-12	19,1	27,7	28,0	4000	112,0	16000	195	0,86
462ST-16	25	1	-16	25,4	35,4	21,0	3000	84,0	12000	250	1,17
462ST-20	32	1.1/4	-20	31,8	43,0	17,2	2495	68,8	9980	335	1,50

The combination of high temperature and high pressure could reduce the hose life.

Information about standard products or non-standard products can be found in the current price list. Dimensions shown may be changed at any time without prior notice.

463 – *No-Skive* Compact Hose

High pressure water cleaning applications

Main Features

- 2 wire *No-Skive* Compact design
- For water up to +120 °C constant temperature
- Suitable with *No-Skive* 46 series fittings

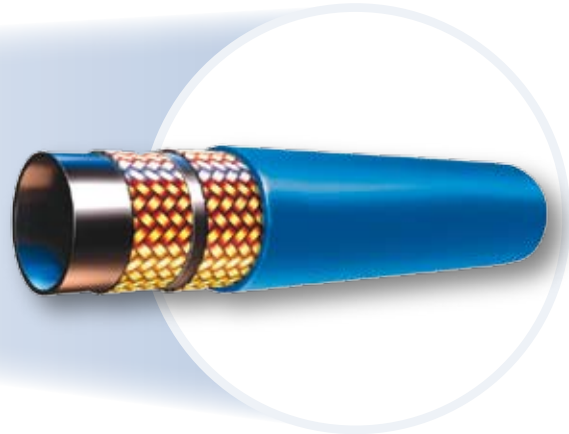

Primary Applications/Restrictions

High pressure water cleaners

Hose Construction

Tube: Synthetic rubber
Reinforcement: Two high tensile steel wire braids
Cover: Synthetic rubber in black or blue colour

Temperature Range water: max. +120 °C

Fittings Series



Part Number XXXX·XX·XX	Hose I.D.				Hose O.D.	Pressure rating				min. bend radius mm	Weight kg/m
	DN	Inch	Size	mm	mm	max. dynamic working pressure		min. burst pressure			
						MPa	psi	MPa	psi		
463-5-RL	8	5/16	-5	7,9	15,0	40,0	5800	120,0	17400	75	0,31
463-5-BLU-RL	8	5/16	-5	7,9	15,0	40,0	5800	120,0	17400	75	0,31
463-6-RL	10	3/8	-6	9,5	17,4	40,0	5800	120,0	17400	90	0,38
463-6-BLU-RL	10	3/8	-6	9,5	17,4	40,0	5800	120,0	17400	90	0,38
463-8-RL	12	1/2	-8	12,7	20,6	35,0	5075	105,0	15225	110	0,48
463-8-BLU-RL	12	1/2	-8	12,7	20,6	35,0	5075	105,0	15225	110	0,48

The combination of high temperature and high pressure could reduce the hose life.
 WKS rubber hand grip for No-Skive high pressure water cleaning hoses can be found on page Eb-12.

Information about standard products or non-standard products can be found in the current price list.
 Dimensions shown may be changed at any time without prior notice.

471TC/472TC – *No-Skive* Compact Hose

EN 857 2SC / ISO11237 Type 2SC

Main Features

- *No-Skive* hose construction – Compact design
- 472TC: Nitrile (NBR) inner tube
– extended fluid compatibility
- Reduced bend radii
- Highly abrasion resistant **TOUGH COVER**

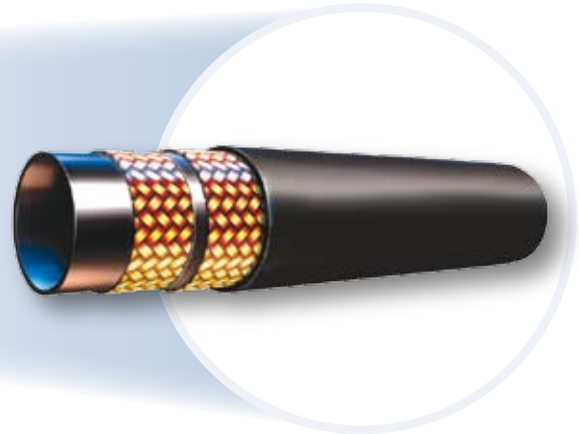

Primary Applications/Restrictions

Small bending radii demanding medium pressure hydraulic applications

Applicable Specifications

EN 857 2SC / ISO11237 Type 2SC

Hose Construction

Tube 471TC: Synthetic rubber
Tube 472TC: Nitrile (NBR)
Reinforcement: Two high tensile steel wire braids
Cover: Synthetic rubber

Recommended Fluids

Petroleum and water-glycol based fluids, lubricating oils, air and water. For air above 1,7 MPa, the hose cover must be pin-pricked.

Consult the chemical compatibility section on page Ab-16 for more detailed information.

Temperature Range

-40 °C up to +100 °C

Exception: Air.....max. +70 °C
 Water.....max. +85 °C

Fittings Series



Part Number	Hose I.D.				Hose O.D. mm	Pressure rating				min. bend radius mm	Weight kg/m
	DN	Inch	Size	mm		max. dynamic working pressure		min. burst pressure			
						MPa	psi	MPa	psi		
471TC-4	6	1/4	-4	6,3	13	40,0	5800	160,0	23200	50	0,30
471TC-5	8	5/16	-5	7,9	15	36,0	5250	144,0	21000	55	0,35
471TC-6	10	3/8	-6	9,5	17	35,0	5000	140,0	20000	65	0,42
471TC-8	12	1/2	-8	12,7	20	29,7	4250	119,0	17000	90	0,52
471TC-10	16	5/8	-10	15,9	24	25,0	3625	100,0	14500	100	0,66
471TC-12	20	3/4	-12	19,1	28	21,5	3125	86,0	12500	120	0,86
471TC-16	25	1	-16	25,4	35	17,5	2500	70,0	10000	150	1,17
472TC-20	32	1.1/4	-20	31,8	45	15,7	2250	63,0	9000	210	2,01
472TC-24	40	1.1/2	-24	38,1	51	12,5	1800	50,0	7200	250	2,16
472TC-32	50	2	-32	50,8	65	9,0	1300	36,0	5200	315	2,90

The combination of high temperature and high pressure could reduce the hose life.

Information about standard products or non-standard products can be found in the current price list. Dimensions shown may be changed at any time without prior notice.

492 – Elite Compact Hose

EN 857 1SC / ISO11237 Type 1SC

Main Features

- *No-Skive* hose construction – Compact design
- Nitrile (NBR) inner tube
– extended fluid compatibility
- Exceeding EN/ISO specifications for pressure, bending radius and abrasion resistance

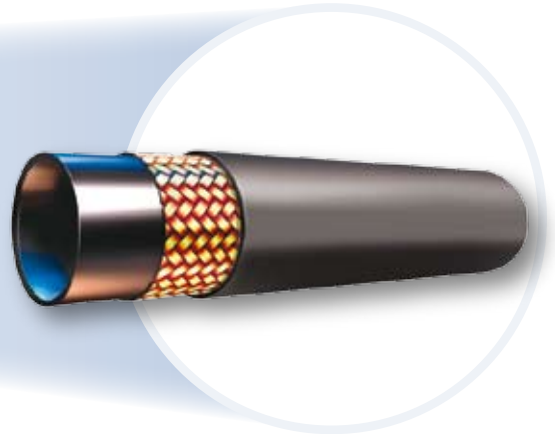

Primary Applications/Restrictions

Demanding medium pressure hydraulic applications

Applicable Specifications

EN 857 1SC / ISO11237 Type 1SC

Hose Construction

Tube: Nitrile (NBR)
Reinforcement: One high tensile steel wire braid
Cover: Synthetic rubber

Recommended Fluids

Petroleum and water-glycol based fluids, lubricating oils, air and water. For air above 1,7 MPa, the hose cover must be pin-pricked.

Consult the chemical compatibility section on page Ab-16 for more detailed information.

Temperature Range

-40 °C up to +100 °C

Exception: Air.....max. +70 °C
 Water.....max. +85 °C

Fittings Series



Part Number	Hose I.D.				Hose O.D. mm	Pressure rating				min. bend radius mm	Weight kg/m
	DN	Inch	Size	mm		max. dynamic working pressure		min. burst pressure			
						MPa	psi	MPa	psi		
492-4	6	1/4	-4	6,3	11,5	28,0	4060	112,0	16240	75	0,18
492-5	8	5/16	-5	7,9	13,6	25,0	3625	100,0	14500	85	0,21
492-6	10	3/8	-6	9,5	15,5	22,5	3260	90,0	13050	90	0,25
492-8	12	1/2	-8	12,7	18,9	19,0	2755	76,0	11020	130	0,33
492-10	16	5/8	-10	15,9	22,2	15,0	2175	60,0	8700	150	0,41
492-12	20	3/4	-12	19,1	26,0	15,0	2175	60,0	8700	180	0,56
492-16	25	1	-16	25,4	33,3	11,0	1595	44,0	6380	230	0,75
492-4-WR	6	1/4	-4	6,3	11,5	28,0	4060	112,0	16240	75	0,18
492-5-WR	8	5/16	-5	7,9	13,6	25,0	3625	100,0	14500	85	0,21
492-6-WR	10	3/8	-6	9,5	15,5	22,5	3260	90,0	13050	90	0,25
492-8-WR	12	1/2	-8	12,7	18,9	19,0	2755	76,0	11020	130	0,33
492-10-WR	16	5/8	-10	15,9	22,2	15,0	2175	60,0	8700	150	0,41
492-12-WR	20	3/4	-12	19,1	26,0	15,0	2175	60,0	8700	180	0,56
492-16-WR	25	1	-16	25,4	33,3	11,0	1595	44,0	6380	230	0,75
492-20-WR	32	1.1/4	-20	31,8	40,0	7,5	1085	30,0	4350	335	0,93

The combination of high temperature and high pressure could reduce the hose life.

Part Number without a suffix: the hose cover has a smooth appearance.
 Part Number with a suffix (WR): the hose cover has a wrapped appearance.

Information about standard products or non-standard products can be found in the current price list.
 Dimensions shown may be changed at any time without prior notice.

492ST – *Elite* Super Tough Compact Hose

EN 857 1SC / ISO11237 Type 1SC

Main Features

- *No-Skive* hose construction – Compact design
- Nitrile (NBR) inner tube – extended fluid compatibility
- Extreme abrasion resistant **SUPER TOUGH** cover

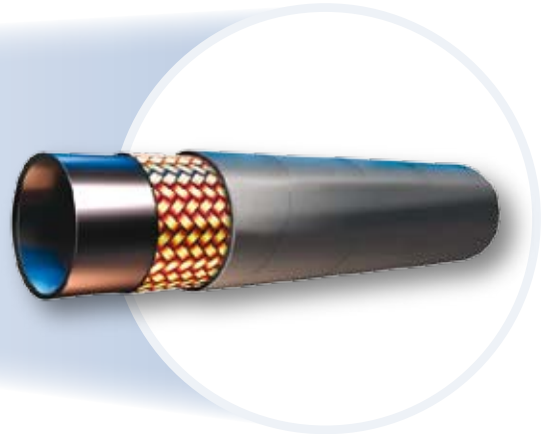

Primary Applications/Restrictions

Mobile market:

Medium pressure hydraulic applications with extremely high abrasion risks

Applicable Specifications

EN 857 1SC / ISO11237 Type 1SC

Hose Construction

- Tube:** Nitrile (NBR)
Reinforcement: One high tensile steel wire braid
Cover: Synthetic rubber with a special polyethylene coating

Recommended Fluids

Petroleum and water-glycol based fluids, lubricating oils, air and water. For air above 1,7 MPa, the hose cover must be pin-pricked.

Consult the chemical compatibility section on page Ab-16 for more detailed information.

Temperature Range

-40 °C up to +100 °C

Exception: Air.....max. +70 °C
 Water.....max. +85 °C

Fittings Series



Part Number XXXX-XX-XX	Hose I.D.				Hose O.D.	Pressure rating				min. bend radius mm	Weight kg/m
						max. dynamic working pressure		min. burst pressure			
	DN	Inch	Size	mm	mm	MPa	psi	MPa	psi		
492ST-4	6	1/4	-4	6,3	12,0	28,0	4000	112,0	16240	75	0,18
492ST-5	8	5/16	-5	7,9	13,6	25,0	3625	100,0	14500	85	0,21
492ST-6	10	3/8	-6	9,5	15,5	22,5	3260	90,0	13050	90	0,25
492ST-8	12	1/2	-8	12,7	18,9	19,0	2755	76,0	11020	130	0,33
492ST-10	16	5/8	-10	15,9	22,3	15,0	2175	60,0	8700	150	0,41
492ST-12	20	3/4	-12	19,1	26,0	15,0	2175	60,0	8700	180	0,56
492ST-16	25	1	-16	25,4	33,6	11,0	1595	44,0	6380	230	0,75
492ST-20	32	1.1/4	-20	31,8	40,0	7,5	1085	30,0	4350	335	0,93

The combination of high temperature and high pressure could reduce the hose life.

Information about standard products or non-standard products can be found in the current price list. Dimensions shown may be changed at any time without prior notice.

493 – *No-Skive* Compact Hose

High pressure water cleaning applications

Main Features

- One wire *No-Skive* construction
- For water up to +120 °C constant temperature
- Suitable with 48 series *No-Skive* fittings

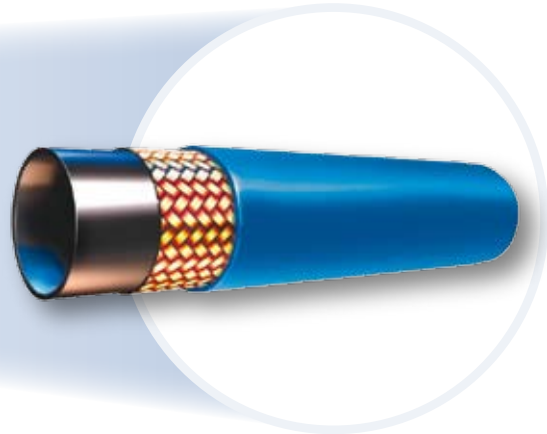

Primary Applications/Restrictions

High pressure water cleaners

Hose Construction

Tube: Synthetic rubber
Reinforcement: One high tensile steel wire braid
Cover: Synthetic rubber in black or blue colour

Temperature Range water: max. +120 °C

Fittings Series



XXXX-XX-XX Part Number	Hose I.D.				Hose O.D.	Pressure rating				min. bend radius mm	Weight kg/m
	DN	Inch	Size	mm	mm	max. dynamic working pressure		min. burst pressure			
						MPa	psi	MPa	psi		
493-4-RL	6	1/4	-4	6,3	13,4	20,0	2898	60,0	8695	60	0,18
493-4-BLU-RL	6	1/4	-4	6,3	13,4	20,0	2898	60,0	8695	60	0,18
493-5-RL	8	5/16	-5	7,9	15,0	20,0	2898	60,0	8695	75	0,21
493-5-BLU-RL	8	5/16	-5	7,9	15,0	20,0	2898	60,0	8695	75	0,21
493-6-RL	10	3/8	-6	9,5	17,4	20,0	2898	60,0	8695	90	0,25
493-6-BLU-RL	10	3/8	-6	9,5	17,4	20,0	2898	60,0	8695	90	0,25
493-8-RL	12	1/2	-8	12,7	20,6	17,5	2536	52,5	7608	110	0,33
493-8-BLU-RL	12	1/2	-8	12,7	20,6	17,5	2536	52,5	7608	110	0,33

The combination of high temperature and high pressure could reduce the hose life.
 WKS rubber hand grip for No-Skive high pressure water cleaning hoses can be found on page Eb-12.

Information about standard products or non-standard products can be found in the current price list.
 Dimensions shown may be changed at any time without prior notice.

692 – Elite Compact Hose

Constant pressure hose with tight bending radius

Main Features

- *No-Skive* hose construction – Compact design
- Nitrile (NBR) inner tube
– extended fluid compatibility
- Constant pressure hose 21,0 MPa

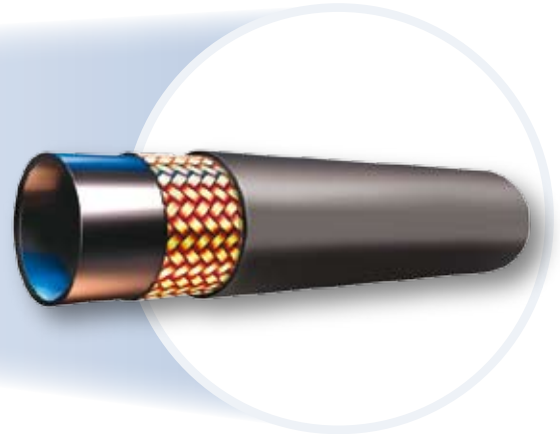

Primary Applications/Restrictions

Material handling:

General small bending radii hydraulic applications; ideal for over the sheave or reel applications

Applicable Specifications

Parker specification

Hose Construction

- Tube:** Nitrile (NBR)
Reinforcement: One or two high tensile steel wire braid
Cover: Synthetic rubber

Recommended Fluids

Petroleum and water-glycol based fluids, lubricating oils, air and water. For air above 1,7 MPa, the hose cover must be pin-pricked.

Consult the chemical compatibility section on page Ab-16 for more detailed information.

Temperature Range -40 °C up to +80 °C

Exception: Air max. +70 °C

Fittings Series



XXXX-XX-XX Part Number	Hose I.D.				Hose O.D.	Pressure rating				min. bend radius mm	Weight kg/m
						max. dynamic working pressure		min. burst pressure			
	DN	Inch	Size	mm	mm	MPa	psi	MPa	psi		
692-4	6	1/4	-4	6,3	11,5	21,0	3045	84,0	12180	40	0,18
692-5	8	5/16	-5	7,9	13,6	21,0	3045	84,0	12180	40	0,21
692-6	10	3/8	-6	9,5	15,5	21,0	3045	84,0	12180	40	0,25
692-8	12	1/2	-8	12,7	20,4	21,0	3045	84,0	12180	50	0,52
692-10	16	5/8	-10	15,9	23,9	21,0	3045	84,0	12180	60	0,66

The combination of high temperature and high pressure could reduce the hose life.

Information about standard products or non-standard products can be found in the current price list. Dimensions shown may be changed at any time without prior notice.

692Twin – *Elite* Compact Hose

Twin constant pressure hose with tight bending radius

Main Features

- *No-Skive* hose construction – Compact design
- Nitrile (NBR) inner tube
– extended fluid compatibility
- Constant pressure hose 21,0 MPa

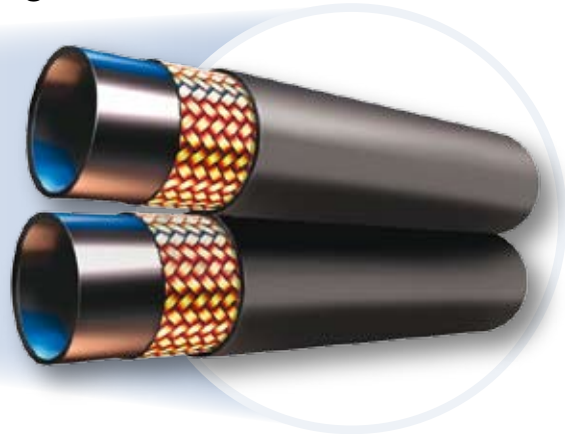

Primary Applications/Restrictions

Lifting and material handling equipment:

General small bending radii hydraulic applications;
over the sheave or reel applications

Applicable Specifications

Parker specification

Hose Construction

- Tube:** Nitrile (NBR)
Reinforcement: One or two high tensile steel wire braid
Cover: Synthetic rubber

Recommended Fluids

Petroleum and water-glycol based fluids, lubricating oils, air and water. For air above 1,7 MPa, the hose cover must be pin-pricked.

Consult the chemical compatibility section on page Ab-16 for more detailed information.

Temperature Range

-40 °C up to +80 °C

Exception: Air.....max. +70 °C

Fittings Series



Part Number XXXX-XX-XX	Hose I.D.				Hose O.D. mm	Pressure rating				min. bend radius mm	Weight kg/m
	Hose I.D.					max. dynamic working pressure		min. burst pressure			
	DN	Inch	Size	mm		MPa	psi	MPa	psi		
692-4-4	6	1/4	-4	6,3	25,8	21,0	3045	84,0	12180	40	0,34
692-5-5	8	5/16	-5	7,9	27,4	21,0	3045	84,0	12180	40	0,40
692-6-6	10	3/8	-6	9,5	31,2	21,0	3045	84,0	12180	40	0,48
692-8-8	12	1/2	-8	12,7	41,5	21,0	3045	84,0	12180	50	1,02
692-10-10	16	5/8	-10	15,9	48,7	21,0	3045	84,0	12180	60	1,30

The combination of high temperature and high pressure could reduce the hose life.

Information about standard products or non-standard products can be found in the current price list.
Dimensions shown may be changed at any time without prior notice.

811 – *No-Skive* Suction and Return Line Hose

SAE 100 R4

Main Features

- *No-Skive* hose construction
- Small bend radii

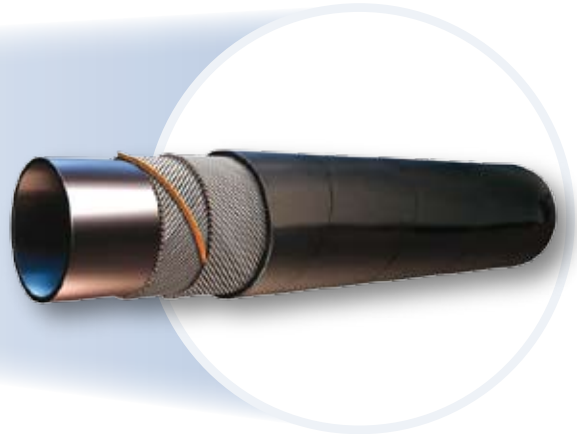

Primary Applications/Restrictions

All Markets: General applications

Hose Construction

Tube: Synthetic rubber
Reinforcement: Two textile braids, combined with wire spiraled throughout the textile reinforcement to prevent collapse under vacuum
Cover: Oil and weather resistant synthetic rubber cover

Recommended Fluids

Petroleum and water-glycol based fluids, lubricating oils, air and water.
 Consult the chemical compatibility section on page Ab-16 for more detailed information.

Temperature Range -40 °C up to +100 °C

Exception: Air.....max. +70 °C
 Water.....max. +85 °C

Fittings Series



XXXX-XX-XX Part Number	Hose I.D.				Hose O.D. mm	Pressure rating				Vacuum kilo Pascal*1 kPa	min. bend radius mm	Weight kg/m
	DN	Inch	Size	mm		max. dynamic working pressure		min. burst pressure				
						MPa	psi	MPa	psi			
811-12**	20	3/4	-12	19,1	30,0	2,1	300	8,3	1200	85	65	0,63
811-16**	25	1	-16	25,4	38,0	1,7	250	6,9	1000	85	75	0,96
811-20	32	1-1/4	-20	31,8	45,0	1,4	200	5,5	800	85	100	1,22
811-24	40	1-1/2	-24	38,1	52,0	1,0	150	4,1	600	85	130	1,55
811-32	50	2	-32	50,8	64,0	0,7	100	2,8	400	85	150	1,87

*1 = the vacuum values listed in the table are vacuum pressure values in kPa. For an absolute value subtract the table value from 101 kPa
 Size 40 and 48 on request, with series 88 nipple plus clamp.
 ** size -12 and size -16 = on Parkrimp 2 crimping press or adjustable crimpers only

Information about standard products or non-standard products can be found in the current price list.
 Dimensions shown may be changed at any time without prior notice.

881 – *No-Skive* Suction and Return Line Hose

SAE 100 R4

Main Features

- *No-Skive* hose construction
- Up to +121 °C working temperature
- MSHA - approved hose cover

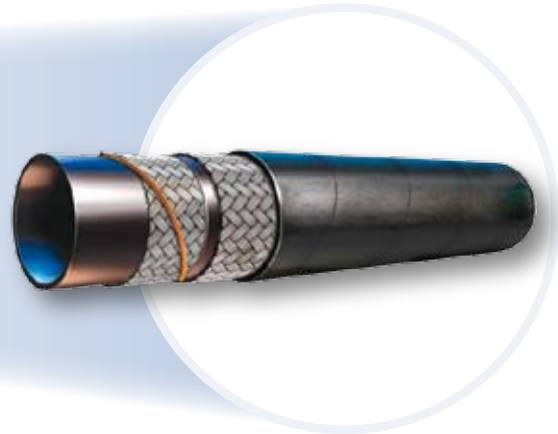

Primary Applications/Restrictions

All Markets: For high temperature applications
For general applications

Hose Construction

Tube: Synthetic rubber
Reinforcement: Two textile braids, combined with wire spiraled throughout the textile reinforcement to prevent collapse under vacuum
Cover: Synthetic rubber
MSHA approved cover

Recommended Fluids

Petroleum and water-glycol based fluids, lubricating oils, air and water.
Consult the chemical compatibility section on page Ab-16 for more detailed information.

Temperature Range -40 °C up to +121 °C

Exception: Air..... max. +70 °C
Water..... max. +85 °C

Fittings Series

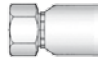

size -12/-16 series 43
size -20/-24/-32 series 48











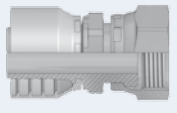
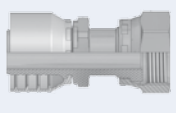
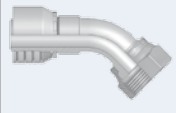

Part Number XXXX-XX-XX	Hose I.D.				Hose O.D. mm	Pressure rating				Vacuum kilo Pascal*1 kPa	min. bend radius mm	Weight kg/m
	DN	Inch	Size	mm		max. dynamic working pressure		min. burst pressure				
						MPa	psi	MPa	psi			
881-12	20	3/4	-12	19,1	30,0	2,1	300	3,0	1200	95	130	0,74
881-16	25	1	-16	25,4	38,0	1,7	250	6,9	1000	95	150	0,89
881-20	32	1.1/4	-20	31,8	45,0	1,4	200	5,5	800	95	200	1,32
881-24	40	1.1/2	-24	38,1	52,0	1,0	150	4,1	600	95	250	1,65
881-32	50	2	-32	50,8	63,0	0,7	100	2,8	400	95	300	1,89

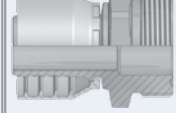
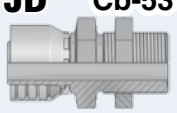
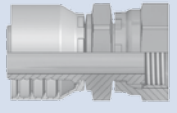
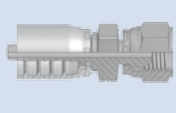

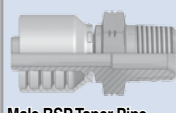
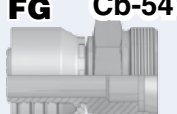





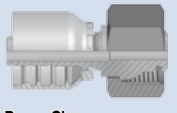
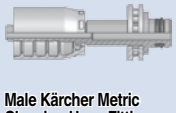
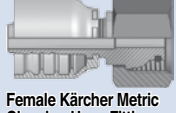

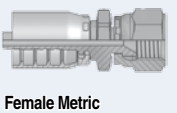
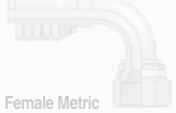

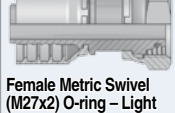







*1 = the vacuum values listed in the table are vacuum pressure values in kPa. For an absolute value subtract the table value from 101 kPa
 ** Sizes -40 and -48 on request, with series 88 nipple plus clamp.

Information about standard products or non-standard products can be found in the current price list.
Dimensions shown may be changed at any time without prior notice.

Fittings Overview 46 / 48 Series

DIN	CA Cb-1 DKOL	CE Cb-2 DKOL 45°	CF Cb-3 DKOL 90°	DO Cb-4 CEL	CO Cb-5 DKM or DKLL	C3 Cb-6 DKL	C4 Cb-7 DKL 45°
	C5 Cb-8 DKL 90°	1D Cb-9 BEL	DD Cb-10 BEL 45°	5D Cb-11 BEL 90°	C9 Cb-12 DKOS	OC Cb-13 DKOS 45°	1C Cb-14 DKOS 90°
	D2 Cb-15 CES	C6 Cb-16 DKS	3D Cb-17 BES	49 Cb-56 Metric Banjo	9B Swivel Female 45° Elbow	9C Swivel Female 90° Elbow	
BSP	92 Cb-18 DKR	B1 Cb-19 DKR 45°	B2 Cb-20 DKR 90°	B4 Cb-21 DKR 90° (Compact)	EA Cb-22 DKOR	EB Cb-23 DKOR 45°	EC Cb-24 DKOR 90°
	D9 Cb-25 AGR	91 Cb-26 AGR-K	B5 Cb-27 Female BSP Parallel Pipe - Swivel (Flat Seat)	34 Standpipe			
SAE	01 Cb-28 AGN	02 Female NPTF Pipe Rigid - Straight	03 Cb-29 AGJ	04 Cb-30 Male SAE 45° - Rigid	05 Cb-31 Male SAE Straight Thread with O-ring - Rigid	06 Cb-32 68 DKJ	08 Cb-33 AGS
	13 Male NPTF Pipe Swivel	33 Cb-34 Male JIC 37° - Rigid	37 Cb-35 3V DKJ 45°	39 Cb-36 3W DKJ 90°	41 Cb-37 3Y DKJ 90°L	L9 Cb-38 DKJ 90° M	93 Cb-39 Female JIC 37° - Swivel (Block Type)
	15 Cb-40 4A SFL	16 SFL 22.5°	17 Cb-41 4F SFL 45°	19 Cb-42 4N SFL 90°	6A Cb-43 SFS	6F Cb-44 SFS 45°	6N Cb-45 SFS 90°
Flange	89 SFL 90° - long	XA Caterpillar Flange Head	XF Caterpillar Flange Head 45°	XG Caterpillar Flange Head 60°	XN Caterpillar Flange Head 90°		

ORFS	JC Cb-46  ORFS - short	JS Cb-47  ORFS - long	J7 Cb-48  ORFS 45°	J9 Cb-49  ORFS Female 90°	J1 Cb-50  ORFS 90° - extra long	J5 Cb-51  ORFS 90° - long	JM Cb-52  ORFS Male	
	JD Cb-53  Male ORFS - Bulkhead with Locknut (with O-ring)							
JIS	FU Cb-61  GUI	GU Cb-62  GUO	MU Cb-63  Female Metric Swivel - (30° Flare)	MZ Cb-64  Female Metric Swivel - (30° Flare)	UT Cb-65  Male BSP Taper Pipe Rigid - (60° Cone)			
	FG Cb-54  Male Rigid Gas Series - (24° Cone)	F2 Cb-55  Female Swivel Gas Series	F4 Cb-57  Female Swivel Gas Series - (Ball Nose)	F6 Cb-58  Male Metric (24° Cone)	F9 Cb-59  Swivel Female Metric (Ball Nose)	FA Cb-60  Metric Male for Agriculture Valves		
High Pressure Cleaning	CW Cb-69  Power Cleaner Connection	PW Cb-71  Male Kärcher Metric Cleaning Hose Fitting - Rigid	NW Cb-70  Female Kärcher Metric Cleaning Hose Fitting - (New Design)					

others	XU Cb-66  Female Metric Swivel - (30° Flare)	XY  Female Metric Swivel - (30° Flare)	DK Cb-67  Male Metric L - Rigid Bulkhead with Locknut (24° Cone)	DX Cb-68  Female Metric Swivel (M27x2) O-ring - Light Series	FF  Metru-Lok Swivel Female	AF  Male BSP Parallel Pipe Rigid - Straight (with O-ring Seal)	NM  Male BSP Parallel Pipe - L Series - Rigid Straight - ED-Seal
	YW  Male Standpipe - Rigid - Straight - A-Lok	VW121  BSP Swivel Female	82  Push-Lok Union	DP  Metric Swivel Female Tee / Male Stud	DR  Metric Swivel Female Tee	5C  60° Cone Swivel Female	6C  60° Cone Swivel Female - 45° Elbow
	7C  60° Cone Swivel Female - 90° Elbow	5S  Female Tube O-ring Swivel - Short Pilot	5H  Female Tube O-ring Swivel - 45° Elbow Short Pilot	5T  Female Tube O-ring Swivel 90° Elbow Short Pilot	59PT  Male Tube O-ring Swivel - Long Pilot Charge Port at 180° for R134a	5LPT  Female Tube O-ring Swivel - 90° Elbow Long Pilot Charge Port at 180° for R134a	T1  Male Refrigerant Tube Mender - Straight (with Nut and Ferrule)

CA – Female Metric 24° – Light Series with O-ring – Swivel – Straight

ISO 12151-2-SWS-L – DKOL

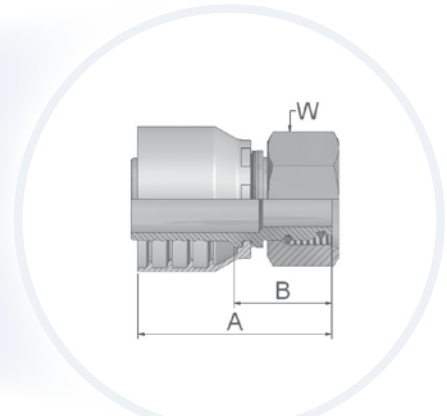
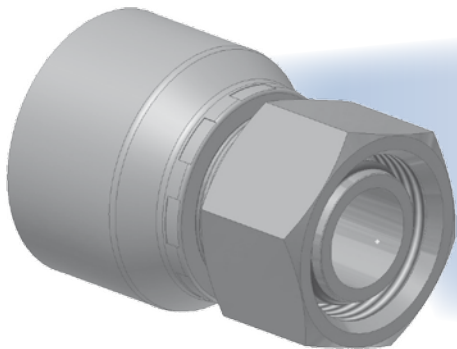

Approved fitting series for hose types:



XXXX-XX-XX Part Number		Hose I.D.				Thread metric	Tube O.D. mm	A mm	B mm	W mm
46	48	DN	Inch	Size	mm					
1CA46-6-4	1CA48-6-4	6	1/4	-4	6,3	M12x1,5	6	46	22	14
1CA46-8-4	1CA48-8-4	6	1/4	-4	6,3	M14x1,5	8	46	22	17
1CA46-10-4	1CA48-10-4	6	1/4	-4	6,3	M16x1,5	10	46	22	19
1CA46-12-4	1CA48-12-4	6	1/4	-4	6,3	M18x1,5	12	46	22	22
1CA46-8-5	1CA48-8-5	8	5/16	-5	7,9	M14x1,5	8	51	26	17
1CA46-10-5	1CA48-10-5	8	5/16	-5	7,9	M16x1,5	10	46	22	19
1CA46-12-5	1CA48-12-5	8	5/16	-5	7,9	M18x1,5	12	46	23	22
1CA46-8-6	1CA48-8-6	10	3/8	-6	9,5	M14x1,5	8	49	26	17
1CA46-10-6	1CA48-10-6	10	3/8	-6	9,5	M16x1,5	10	46	23	19
1CA46-12-6	1CA48-12-6	10	3/8	-6	9,5	M18x1,5	12	46	23	22
1CA46-15-6	1CA48-15-6	10	3/8	-6	9,5	M22x1,5	15	47	24	27
1CA46-18-6	1CA48-18-6	10	3/8	-6	9,5	M26x1,5	18	50	28	32
1CA46-12-8	1CA48-12-8	12	1/2	-8	12,7	M18x1,5	12	50	26	22
1CA46-15-8	1CA48-15-8	12	1/2	-8	12,7	M22x1,5	15	50	26	27
1CA46-18-8	1CA48-18-8	12	1/2	-8	12,7	M26x1,5	18	49	25	32
1CA46-15-10	1CA48-15-10	16	5/8	-10	15,9	M22x1,5	15	54	29	27
1CA46-18-10	1CA48-18-10	16	5/8	-10	15,9	M26x1,5	18	51	26	32
1CA46-18-12	1CA48-18-12	20	3/4	-12	19,1	M26x1,5	18	51	25	32
1CA46-22-10	1CA48-22-10	16	5/8	-10	15,9	M30x2	22	55	30	36
1CA46-22-12	1CA48-22-12	20	3/4	-12	19,1	M30x2	22	56	30	36
1CA46-28-12	1CA48-28-12	20	3/4	-12	19,1	M36x2	28	61	35	41
1CA46-22-16	1CA48-22-16	25	1	-16	25,4	M30x2	22	60	30	36
1CA46-28-16	1CA48-28-16	25	1	-16	25,4	M36x2	28	63	33	41
1CA46-35-16	1CA48-35-16	25	1	-16	25,4	M45x2	35	63	33	50
	1CA48-28-20	32	1-1/4	-20	31,8	M36x2	28	81	34	41
1CA46-35-20		32	1-1/4	-20	31,8	M45x2	35	66	28	50
	1CA48-35-20	32	1-1/4	-20	31,8	M45x2	35	82	35	50
	1CA48-42-24	40	1-1/2	-24	38,1	M52x2	42	77	39	60
	1CA48-42-24C	40	1-1/2	-24	38,1	M52x2	42	77	39	60

Hose fittings are delivered with ozone resistant Nitrile (NBR) O-ring as a standard version. Working temperature from -30 °C up to +105 °C. Hose fittings with special O-rings (Viton or EPDM) available on request. For O-ring dimensions and part-numbers see Section Eb.

Information about standard products or non-standard products can be found in the current price list. Dimensions shown may be changed at any time without prior notice.

Material: steel chromium(VI) free plated
C: Stainless Steel

CE – Female Metric 24° – Light Series with O-ring – Swivel – 45° Elbow

ISO 12151-2-SWE45-L – DKOL 45°

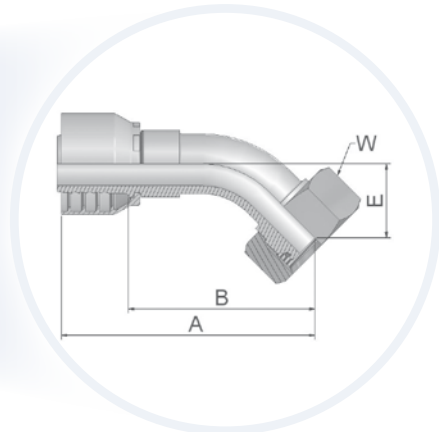
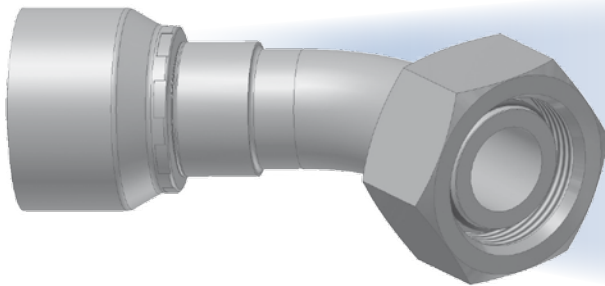

Approved fitting series for hose types:

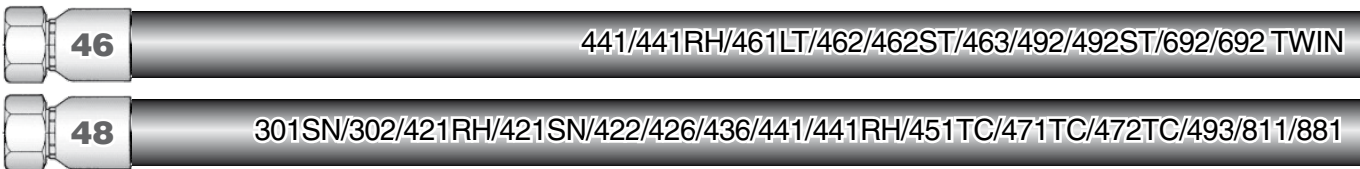

XXXX-XX-XX Part Number		Hose I.D.				Thread metric	Tube O.D. mm	A mm	B mm	E mm	W mm
46	48	DN	Inch	Size	mm						
1CE46-6-4	1CE48-6-4	6	1/4	-4	6,3	M12x1,5	6	70	46	19	14
1CE46-8-4	1CE48-8-4	6	1/4	-4	6,3	M14x1,5	8	59	35	16	17
1CE46-10-4	1CE48-10-4	6	1/4	-4	6,3	M16x1,5	10	59	35	16	19
1CE46-12-4	1CE48-12-4	6	1/4	-4	6,3	M18x1,5	12	59	36	16	22
1CE46-8-5	1CE48-8-5	8	5/16	-5	7,9	M14x1,5	8	64	41	19	17
1CE46-10-5	1CE48-10-5	8	5/16	-5	7,9	M16x1,5	10	67	44	16	19
1CE46-12-5	1CE48-12-5	8	5/16	-5	7,9	M18x1,5	12	62	38	17	22
1CE46-10-6	1CE48-10-6	10	3/8	-6	9,5	M16x1,5	10	68	45	20	19
1CE46-12-6	1CE48-12-6	10	3/8	-6	9,5	M18x1,5	12	68	45	19	22
1CE46-15-6	1CE48-15-6	10	3/8	-6	9,5	M22x1,5	15	69	46	20	27
1CE46-12-8	1CE48-12-8	12	1/2	-8	12,7	M18x1,5	12	74	51	23	22
1CE46-15-8	1CE48-15-8	12	1/2	-8	12,7	M22x1,5	15	71	47	22	27
1CE46-18-8	1CE48-18-8	12	1/2	-8	12,7	M26x1,5	18	71	47	22	32
1CE46-15-10	1CE48-15-10	16	5/8	-10	15,9	M22x1,5	15	79	54	26	27
1CE46-18-10	1CE48-18-10	16	5/8	-10	15,9	M26x1,5	18	76	50	23	32
1CE46-22-10	1CE48-22-10	16	5/8	-10	15,9	M30x2	22	82	57	24	36
1CE46-18-12	1CE48-18-12	20	3/4	-12	19,1	M26x1,5	18	90	64	28	32
1CE46-22-12	1CE48-22-12	20	3/4	-12	19,1	M30x2	22	89	62	26	36
1CE46-28-12	1CE48-28-12	20	3/4	-12	19,1	M36x2	28	90	64	28	41
1CE46-22-16	1CE48-22-16	25	1	-16	25,4	M30x2	22	108	78	33	36
1CE46-28-16	1CE48-28-16	25	1	-16	25,4	M36x2	28	113	83	33	41
1CE46-35-20		32	1-1/4	-20	31,8	M45x2	35	130	92	32	50
	1CE48-35-20	32	1-1/4	-20	31,8	M45x2	35	141	94	38	50
	1CE48-42-24	40	1-1/2	-24	38,1	M52x2	42	155	117	49	60
	1CE48-42-24C	40	1-1/2	-24	38,1	M52x2	42	155	117	49	60

Hose fittings are delivered with ozone resistant Nitrile (NBR) O-ring as a standard version. Working temperature from -30 °C up to +105 °C. Hose fittings with special O-rings (Viton or EPDM) available on request. For O-ring dimensions and part-numbers see Section Eb. Material: steel chromium(VI) free plated; C: Stainless Steel

Information about standard products or non-standard products can be found in the current price list. Dimensions shown may be changed at any time without prior notice.

CF – Female Metric 24° – Light Series with O-ring – Swivel – 90° Elbow

ISO 12151-2-SWE-L – DKOL 90°

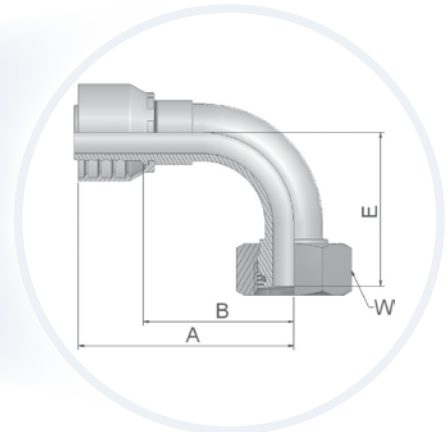
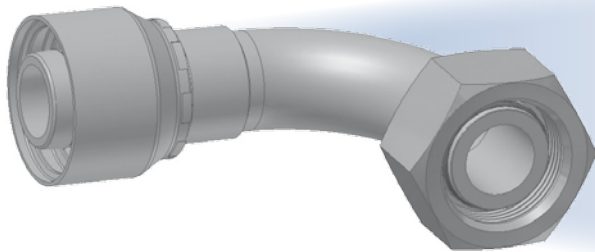

Approved fitting series for hose types:

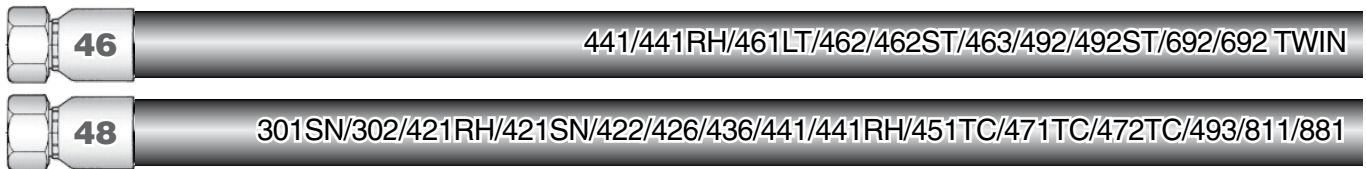

XXXX-XX-XX Part Number		Hose I.D.				Thread metric	Tube O.D.	A	B	E	W
46	48	DN	Inch	Size	mm						
1CF46-6-4	1CF48-6-4	6	1/4	-4	6,3	M12x1,5	6	57	33	33	14
1CF46-8-4	1CF48-8-4	6	1/4	-4	6,3	M14x1,5	8	51	28	29	17
1CF46-10-4	1CF48-10-4	6	1/4	-4	6,3	M16x1,5	10	50	26	29	19
1CF46-12-4	1CF48-12-4	6	1/4	-4	6,3	M18x1,5	12	50	26	29	22
1CF46-8-5	1CF48-8-5	8	5/16	-5	7,9	M14x1,5	8	63	39	34	17
1CF46-10-5	1CF48-10-5	8	5/16	-5	7,9	M16x1,5	10	61	37	29	19
1CF46-12-5	1CF48-12-5	8	5/16	-5	7,9	M18x1,5	12	61	37	30	22
1CF46-10-6	1CF48-10-6	10	3/8	-6	9,5	M16x1,5	10	60	37	37	19
1CF46-12-6	1CF48-12-6	10	3/8	-6	9,5	M18x1,5	12	58	35	36	22
1CF46-15-6	1CF48-15-6	10	3/8	-6	9,5	M22x1,5	15	58	35	36	27
1CF46-18-6	1CF48-18-6	10	3/8	-6	9,5	M26x1,5	18	63	40	38	32
1CF46-12-8	1CF48-12-8	12	1/2	-8	12,7	M18x1,5	12	63	39	45	22
1CF46-15-8	1CF48-15-8	12	1/2	-8	12,7	M22x1,5	15	61	37	43	27
1CF46-18-8	1CF48-18-8	12	1/2	-8	12,7	M26x1,5	18	65	41	43	32
1CF46-15-10	1CF48-15-10	16	5/8	-10	15,9	M22x1,5	15	66	41	50	27
1CF46-18-10	1CF48-18-10	16	5/8	-10	15,9	M26x1,5	18	66	41	45	32
1CF46-22-10	1CF48-22-10	16	5/8	-10	15,9	M30x2	22	71	46	47	36
1CF46-18-12	1CF48-18-12	20	3/4	-12	19,1	M26x1,5	18	80	54	56	32
1CF46-22-12	1CF48-22-12	20	3/4	-12	19,1	M30x2	22	80	54	55	36
1CF46-28-12	1CF48-28-12	20	3/4	-12	19,1	M36x2	28	76	50	57	41
1CF46-22-16	1CF48-22-16	25	1	-16	25,4	M30x2	22	102	72	74	36
1CF46-28-16	1CF48-28-16	25	1	-16	25,4	M36x2	28	100	70	71	41
	1CF48-22-20	32	1-1/4	-20	31,8	M30x2	22	130	83	81	36
	1CF48-28-20	32	1-1/4	-20	31,8	M36x2	28	130	83	81	41
1CF46-35-20		32	1-1/4	-20	31,8	M45x2	35	124	87	79	50
	1CF48-35-20	32	1-1/4	-20	31,8	M45x2	35	130	83	79	50
	1CF48-42-24	40	1-1/2	-24	38,1	M52x2	42	139	101	101	60
	1CF48-42-24C	40	1-1/2	-24	38,1	M52x2	42	138	101	101	60

Standard hose fittings are delivered with ozone resistant Nitrile O-ring. See section Eb for special O-rings and dimensions. Information about standard products or non-standard products can be found in the current price list. Material: steel chromium(VI) free plated C: Stainless Steel. Dimensions shown may be changed at any time without prior notice.

DO – Male Metric 24° – Light Series – Rigid – Straight

ISO 12151-2-S-L – CEL

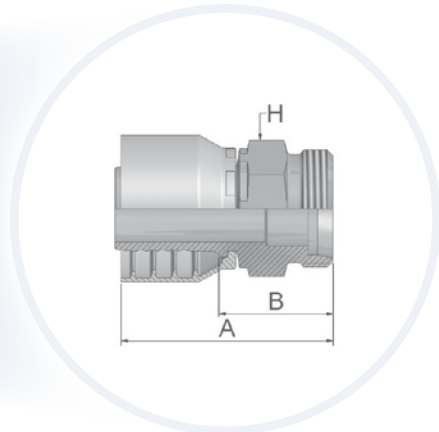
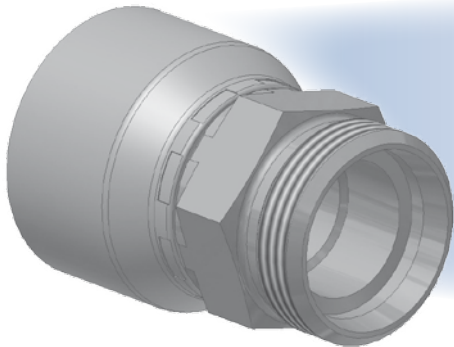

Approved fitting series for hose types:

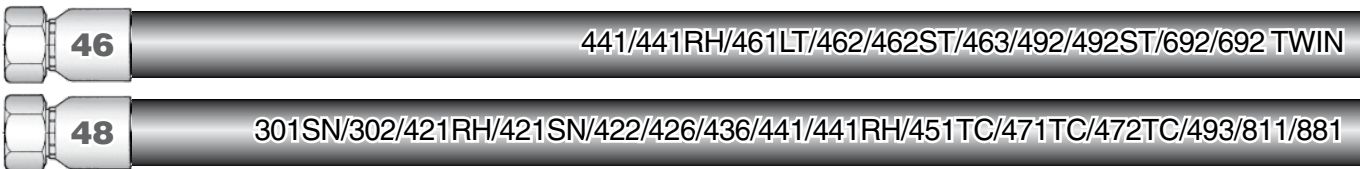

XXXX-XX-XX Part Number		Hose I.D.				Thread metric	Tube O.D. mm	A mm	B mm	H mm
46	48	DN	Inch	Size	mm					
1D046-6-4	1D048-6-4	6	1/4	-4	6,3	M12x1,5	6	44	20	12
1D046-8-4	1D048-8-4	6	1/4	-4	6,3	M14x1,5	8	46	22	14
1D046-10-4	1D048-10-4	6	1/4	-4	6,3	M16x1,5	10	48	24	17
1D046-12-4	1D048-12-4	6	1/4	-4	6,3	M18x1,5	12	48	24	19
1D046-8-5	1D048-8-5	8	5/16	-5	7,9	M14x1,5	8	44	20	14
1D046-10-5	1D048-10-5	8	5/16	-5	7,9	M16x1,5	10	48	24	17
1D046-12-5	1D048-12-5	8	5/16	-5	7,9	M18x1,5	12	48	24	19
1D046-10-6	1D048-10-6	10	3/8	-6	9,5	M16x1,5	10	47	24	17
1D046-12-6	1D048-12-6	10	3/8	-6	9,5	M18x1,5	12	47	24	19
1D046-15-6	1D048-15-6	10	3/8	-6	9,5	M22x1,5	15	49	26	22
1D046-12-8	1D048-12-8	12	1/2	-8	12,7	M18x1,5	12	47	23	19
1D046-15-8	1D048-15-8	12	1/2	-8	12,7	M22x1,5	15	50	26	22
1D046-18-8	1D048-18-8	12	1/2	-8	12,7	M26x1,5	18	53	29	27
1D046-15-10	1D048-15-10	16	5/8	-10	15,9	M22x1,5	15	55	30	27
1D046-18-10	1D048-18-10	16	5/8	-10	15,9	M26x1,5	18	55	30	27
1D046-18-12	1D048-18-12	20	3/4	-12	19,1	M26x1,5	18	55	29	27
1D046-22-12	1D048-22-12	20	3/4	-12	19,1	M30x2	22	59	33	30
1D046-28-12	1D048-28-12	20	3/4	-12	19,1	M36x2	28	60	34	36
1D046-28-16	1D048-28-16	25	1	-16	25,4	M36x2	28	65	35	36
1D046-35-20		32	1-1/4	-20	31,8	M45x2	35	78	40	46
	1D048-35-20	32	1-1/4	-20	31,8	M45x2	35	85	38	46
	1D048-42-24	40	1-1/2	-24	38,1	M52x2	42	77	39	55
	1D048-42-24C	40	1-1/2	-24	38,1	M52x2	42	77	39	55

Material: steel chromium(VI) free plated
C: Stainless Steel

Information about standard products or non-standard products can be found in the current price list.
Dimensions shown may be changed at any time without prior notice.



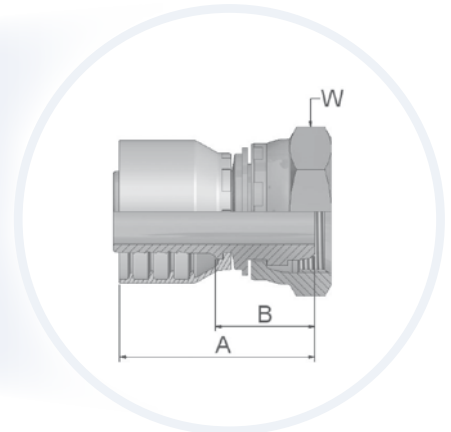
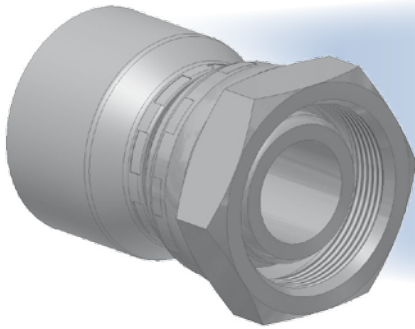

C0 – Female Metric – Very Light Series LL – Swivel – Straight (Ball Nose)

DKM

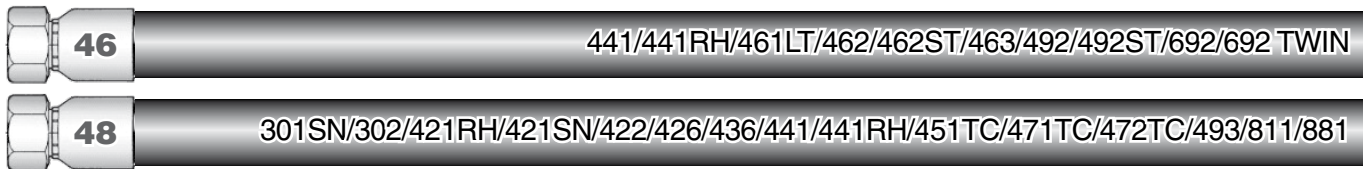

Approved fitting series for hose types:



XXXX-XX-XX Part Number		 Hose I.D.				 Thread metric	 Tube O.D.	A	B	 W
46	48	DN	Inch	Size	mm		mm	mm	mm	mm
1C046-20-12	1C048-20-12	20	3/4	-12	19,1	M30x1,5	22	54	28	36
1C046-25-12	1C048-25-12	20	3/4	-12	19,1	M38x1,5	28	58	32	46
1C046-25-16	1C048-25-16	25	1	-16	25,4	M38x1,5	28	61	32	46
	1C048-32-20	32	1-1/4	-20	31,8	M45x1,5	35	78	31	55
	1C048-42-24	40	1.1/2	-24	38,1	M52x1,5	42	77	39	60
	1C048-50-32	50	2	-32	50,8	M65x2	50	78	29	75

Material: steel chromium(VI) free plated

Information about standard products or non-standard products can be found in the current price list. Dimensions shown may be changed at any time without prior notice.

C3 – Female Metric – Light Series – Swivel – Straight (Ball Nose)

DKL

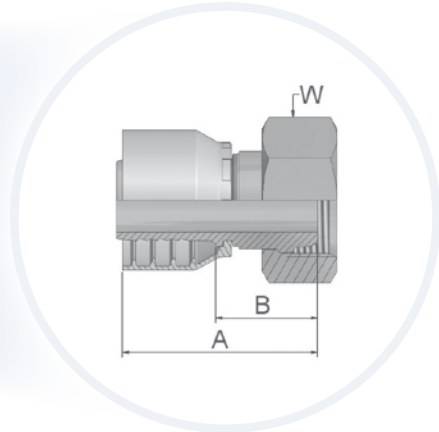
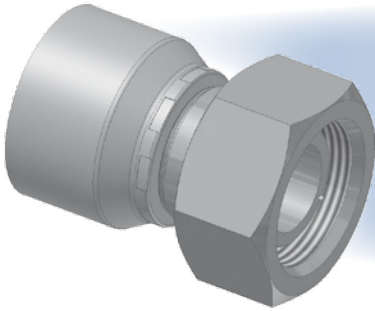

Approved fitting series for hose types:

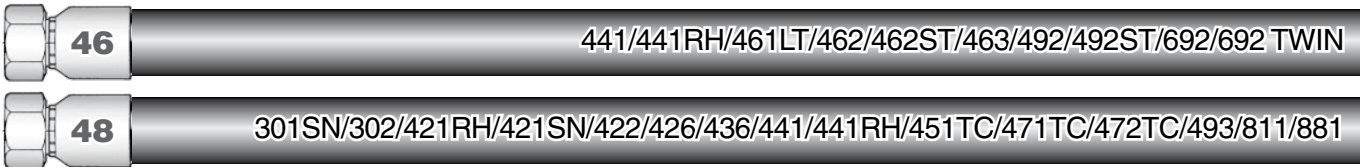

XXXX-XX-XX Part Number		Hose I.D.				Thread metric	Tube O.D.	A	B	W
46	48	DN	Inch	Size	mm					
1C346-6-4	1C348-6-4	6	1/4	-4	6,3	M12x1,5	6	46	22	14
1C346-8-4	1C348-8-4	6	1/4	-4	6,3	M14x1,5	8	45	21	17
1C346-10-4	1C348-10-4	6	1/4	-4	6,3	M16x1,5	10	46	22	19
1C346-10-5	1C348-10-5	8	5/16	-5	7,9	M16x1,5	10	46	22	19
1C346-12-5	1C348-12-5	8	5/16	-5	7,9	M18x1,5	12	46	22	22
1C346-10-6	1C348-10-6	10	3/8	-6	9,5	M16x1,5	10	47	24	19
1C346-12-6	1C348-12-6	10	3/8	-6	9,5	M18x1,5	12	46	23	22
1C346-15-8	1C348-15-8	12	1/2	-8	12,7	M22x1,5	15	48	25	27
1C346-15-10	1C348-15-10	16	5/8	-10	15,9	M22x1,5	15	52	27	27
1C346-18-10	1C348-18-10	16	5/8	-10	15,9	M26x1,5	18	51	26	32
1C346-22-12	1C348-22-12	20	3/4	-12	19,1	M30x2	22	54	28	36
1C346-28-16	1C348-28-16	25	1	-16	25,4	M36x2	28	63	33	41
1C346-35-20		32	1-1/4	-20	31,8	M45x2	35	62	24	50

Material: steel chromium(VI) free plated

Information about standard products or non-standard products can be found in the current price list. Dimensions shown may be changed at any time without prior notice.

C4 – Female Metric – Light Series – Swivel – 45° Elbow (Ball Nose)

DKL 45°

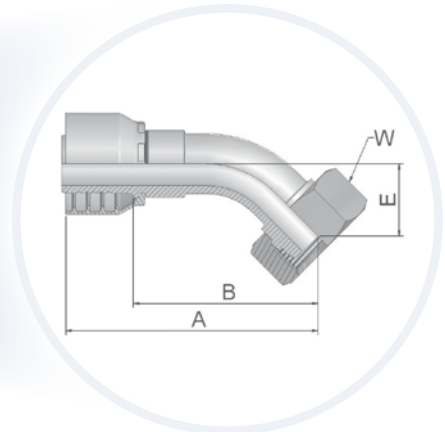
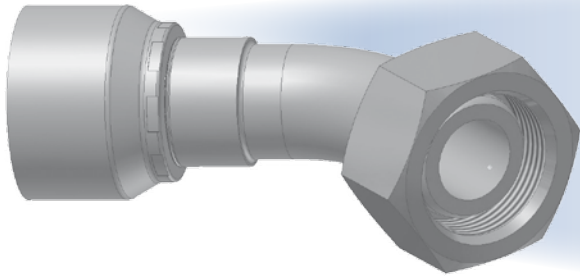

Approved fitting series for hose types:

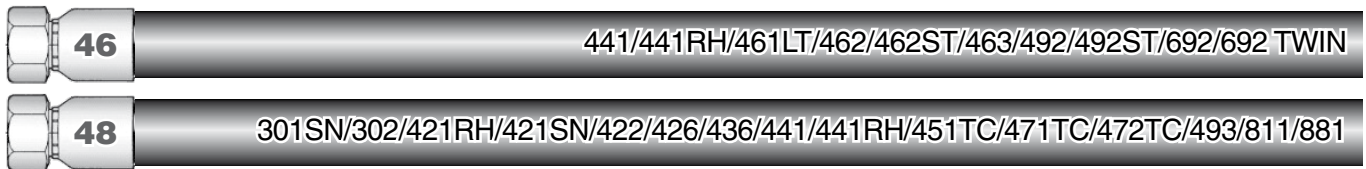

XXXX-XX-XX Part Number 46 48	Hose I.D.				Thread metric	Tube O.D.	A	B	E	W
	DN	Inch	Size	mm						
1C448-8-4	6	1/4	-4	6,3	M14x1,5	8	57	33	14	17
1C448-10-5	8	5/16	-5	7,9	M16x1,5	10	58	34	15	19
1C448-12-6	10	3/8	-6	9,5	M18x1,5	12	67	44	18	22
1C448-15-8	12	1/2	-8	12,7	M22x1,5	15	68	45	19	27

Material: steel chromium(VI) free plated

Information about standard products or non-standard products can be found in the current price list.
Dimensions shown may be changed at any time without prior notice.

C5 – Female Metric – Light Series – Swivel – 90° Elbow (Ball Nose)

DKL 90°

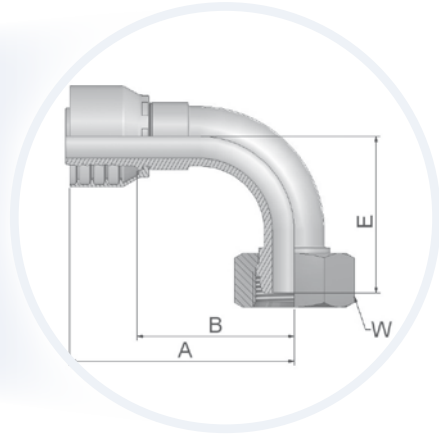
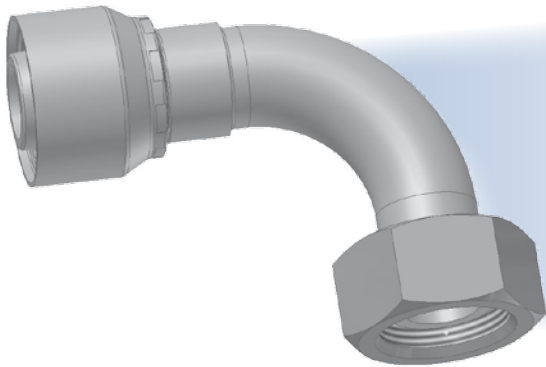

Approved fitting series for hose types:

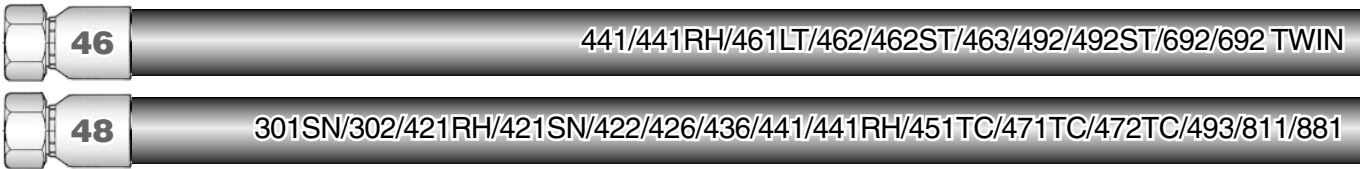

XXXX-XX-XX Part Number		Hose I.D.				Thread metric	Tube O.D. mm	A mm	B mm	E mm	W mm
46	48	DN	Inch	Size	mm						
1C546-6-4	1C548-6-4	6	1/4	-4	6,3	M12x1,5	6	49	25	29	14
1C546-8-4	1C548-8-4	6	1/4	-4	6,3	M14x1,5	8	48	25	26	17
1C546-10-4	1C548-10-4	6	1/4	-4	6,3	M16x1,5	10	49	25	27	19
1C546-10-5	1C548-10-5	8	5/16	-5	7,9	M16x1,5	10	61	38	33	19
	1C548-12-5	8	5/16	-5	7,9	M18x1,5	12	50	26	28	22
1C546-10-6	1C548-10-6	10	3/8	-6	9,5	M16x1,5	10	58	35	35	19
1C546-12-6	1C548-12-6	10	3/8	-6	9,5	M18x1,5	12	58	35	34	22
1C546-15-8	1C548-15-8	12	1/2	-8	12,7	M22x1,5	15	64	41	39	27
1C546-18-10	1C548-18-10	16	5/8	-10	15,9	M26x1,5	18	66	41	43	32
1C546-22-12	1C548-22-12	20	3/4	-12	19,1	M30x2	22	80	54	51	36
1C546-28-16	1C548-28-16	25	1	-16	25,4	M36x2	28	100	70	70	41

Material: steel chromium(VI) free plated

Information about standard products or non-standard products can be found in the current price list. Dimensions shown may be changed at any time without prior notice.

1D – Metric Standpipe – Light Series – Rigid – Straight

ISO 8434-1 – BEL

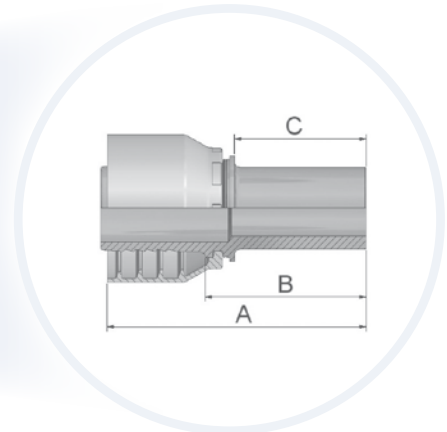
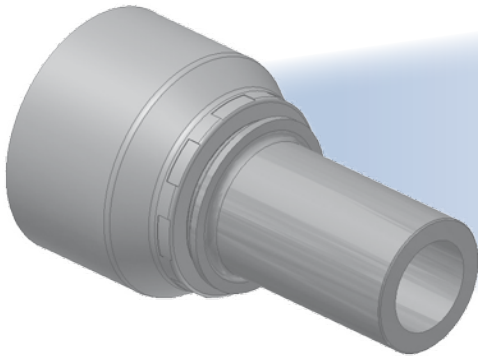

Approved fitting series for hose types:

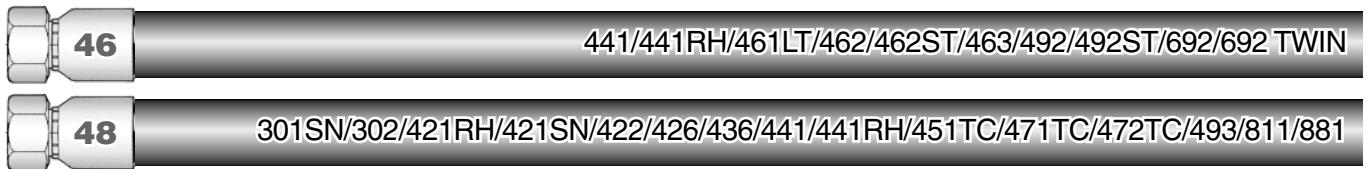

XXXX-XX-XX Part Number		 Hose I.D.				Tube O.D.	A	B	C
46	48	DN	Inch	Size	mm				
11D46-6-4	11D48-6-4	6	1/4	-4	6,3	6	54	30	22
11D46-8-4	11D48-8-4	6	1/4	-4	6,3	8	54	30	22
11D46-10-4	11D48-10-4	6	1/4	-4	6,3	10	55	31	23
11D46-12-4	11D48-12-4	6	1/4	-4	6,3	12	55	31	23
11D46-10-5	11D48-10-5	8	5/16	-5	7,9	10	55	31	23
11D46-10-6	11D48-10-6	10	3/8	-6	9,5	10	54	31	23
11D46-12-6	11D48-12-6	10	3/8	-6	9,5	12	54	31	23
11D46-15-6	11D48-15-6	10	3/8	-6	9,5	15	55	32	25
11D46-12-8	11D48-12-8	12	1/2	-8	12,7	12	55	31	23
11D46-15-8	11D48-15-8	12	1/2	-8	12,7	15	57	33	25
11D46-18-10	11D48-18-10	16	5/8	-10	15,9	18	59	34	26
11D46-22-12	11D48-22-12	20	3/4	-12	19,1	22	62	36	28
11D46-28-16	11D48-28-16	25	1	-16	25,4	28	70	40	30

Not recommended for new construction. Instead use C3 or CA. Should be assembled with cutting ring and nut.
Material: steel chromium(VI) free plated

Information about standard products or non-standard products can be found in the current price list.
Dimensions shown may be changed at any time without prior notice.

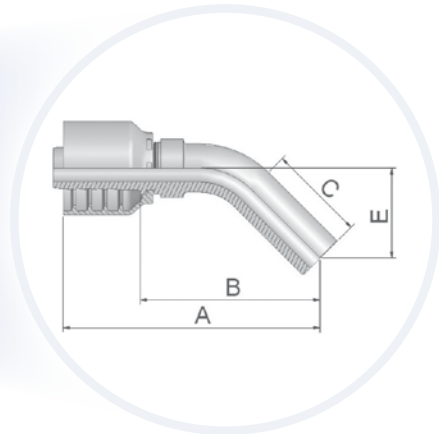
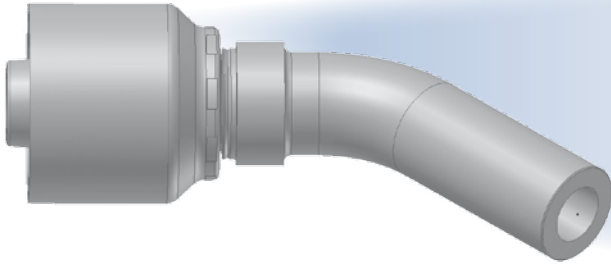

DD – Metric Standpipe – Light Series – Rigid – 45° Elbow

BEL 45°

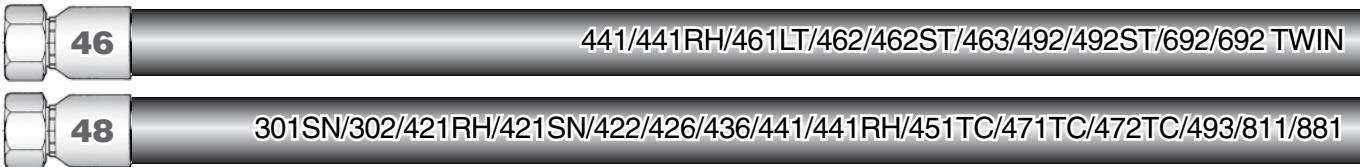

Approved fitting series for hose types:



XXXX-XX-XX Part Number	Hose I.D.				Tube O.D.	A	B	C	E
	DN	Inch	Size	mm					
 									
1DD48-6-4	6	1/4	-4	6,3	6	68	45	21	19
1DD48-8-4	6	1/4	-4	6,3	8	69	46	22	19
1DD48-12-6	10	3/8	-6	9,5	12	72	49	22	21

Not recommended for new construction. Instead use CE. Should be used with cutting ring and nut.
Material: steel chromium(VI) free plated

Information about standard products or non-standard products can be found in the current price list.
Dimensions shown may be changed at any time without prior notice.

5D – Metric Standpipe – Light Series – Rigid – 90° Elbow

ISO 8434-1 – BEL 90°

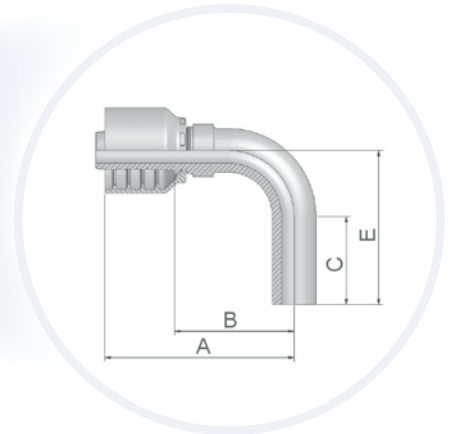
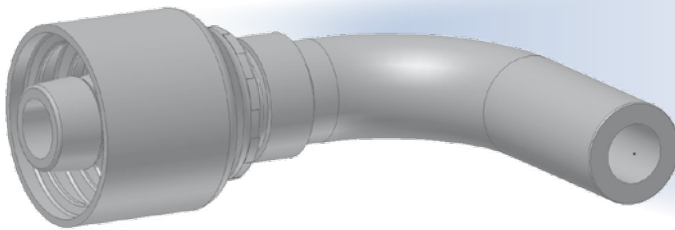

Approved fitting series for hose types:

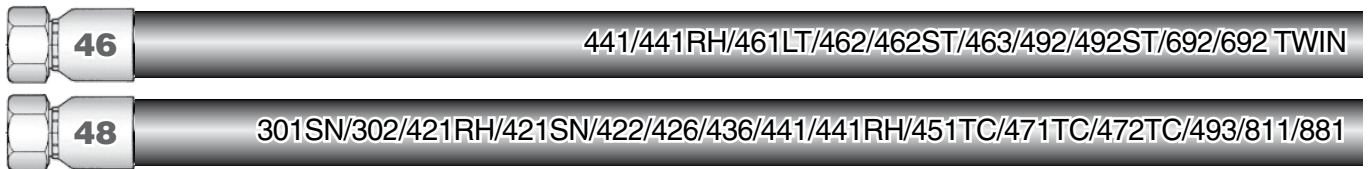

XXXX-XX-XX Part Number	Hose I.D.				Tube O.D.	A	B	C	E
	DN	Inch	Size	mm					
15D48-6-4	6	1/4	-4	6,3	6	56	33	19	30
15D48-8-4	6	1/4	-4	6,3	8	57	34	22	34
15D48-10-5	8	5/16	-5	7,9	10	58	35	25	38
15D48-12-6	10	3/8	-6	9,5	12	62	39	27	44
15D48-15-8	12	1/2	-8	12,7	15	65	41	30	52

Not recommended for new construction. Instead use CF. Should be used with cutting ring and nut.
Material: steel chromium(VI) free plated

Information about standard products or non-standard products can be found in the current price list.
Dimensions shown may be changed at any time without prior notice.

C9 – Female Metric 24° – Heavy Series with O-ring – Swivel – Straight

ISO 12151-2-SWS-S – DKOS

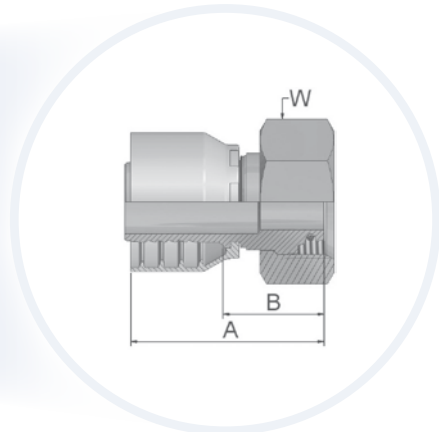
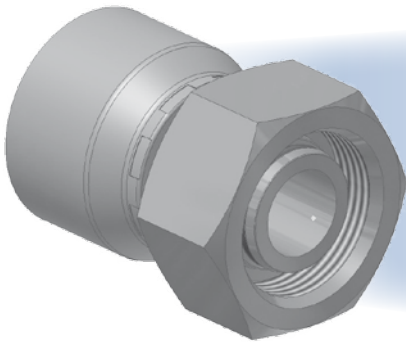

Approved fitting series for hose types:



XXXX-XX-XX Part Number		Hose I.D.				Thread metric	Tube O.D.	A	B	W
46	48	DN	Inch	Size	mm		mm	mm	mm	
1C946-6-4	1C948-6-4	6	1/4	-4	6,3	M14x1,5	6	48	26	17
1C946-8-4	1C948-8-4	6	1/4	-4	6,3	M16x1,5	8	47	23	19
1C946-10-4	1C948-10-4	6	1/4	-4	6,3	M18x1,5	10	46	22	22
1C946-12-4	1C948-12-4	6	1/4	-4	6,3	M20x1,5	12	48	24	24
1C946-14-4	1C948-14-4	6	1/4	-4	6,3	M22x1,5	14	48	24	27
1C946-8-5	1C948-8-5	8	5/16	-5	7,9	M16x1,5	8	46	23	19
1C946-10-5	1C948-10-5	8	5/16	-5	7,9	M18x1,5	10	46	22	22
1C946-12-5	1C948-12-5	8	5/16	-5	7,9	M20x1,5	12	48	24	24
1C946-14-5	1C948-14-5	8	5/16	-5	7,9	M22x1,5	14	48	24	27
1C946-16-5	1C948-16-5	8	5/16	-5	7,9	M24x1,5	16	52	28	30
1C946-8-6	1C948-8-6	10	3/8	-6	9,5	M16x1,5	8	49	26	19
1C946-10-6	1C948-10-6	10	3/8	-6	9,5	M18x1,5	10	45	23	22
1C946-12-6	1C948-12-6	10	3/8	-6	9,5	M20x1,5	12	48	25	24
1C946-14-6	1C948-14-6	10	3/8	-6	9,5	M22x1,5	14	47	24	27
1C946-16-6	1C948-16-6	10	3/8	-6	9,5	M24x1,5	16	50	28	30
1C946-12-8	1C948-12-8	12	1/2	-8	12,7	M20x1,5	12	52	28	24
1C946-14-8	1C948-14-8	12	1/2	-8	12,7	M22x1,5	14	48	24	27
1C946-16-8	1C948-16-8	12	1/2	-8	12,7	M24x1,5	16	52	28	30
1C946-20-8	1C948-20-8	12	1/2	-8	12,7	M30x2	20	53	29	36
1C946-16-10	1C948-16-10	16	5/8	-10	15,9	M24x1,5	16	54	28	30
1C946-20-10	1C948-20-10	16	5/8	-10	15,9	M30x2	20	53	28	36
1C946-20-12	1C948-20-12	20	3/4	-12	19,1	M30x2	20	56	30	36
1C946-25-12	1C948-25-12	20	3/4	-12	19,1	M36x2	25	61	35	46
1C946-25-16	1C948-25-16	25	1	-16	25,4	M36x2	25	63	33	46
1C946-30-16	1C948-30-16	25	1	-16	25,4	M42x2	30	67	38	50
1C946-38-20°		32	1-1/4	-20	31,8	M52x2	38	69	32	60
	1C948-38-20°	32	1-1/4	-20	31,8	M52x2	38	80	33	60

Hose fittings are delivered with ozone resistant Nitrile (NBR) O-ring as a standard version. Working temperature from -30 °C up to +105 °C. Hose fittings with special O-rings (Viton or EPDM) available on request. For O-ring dimensions and part-numbers see Section Eb. Material: steel chromium(VI) free plated; *Assembly only with Parkrimp 2 machine

Information about standard products or non-standard products can be found in the current price list. Dimensions shown may be changed at any time without prior notice.

OC – Female Metric 24° – Heavy Series with O-ring – Swivel – 45° Elbow

ISO 12151-2-SWE45-S – DKOS 45°

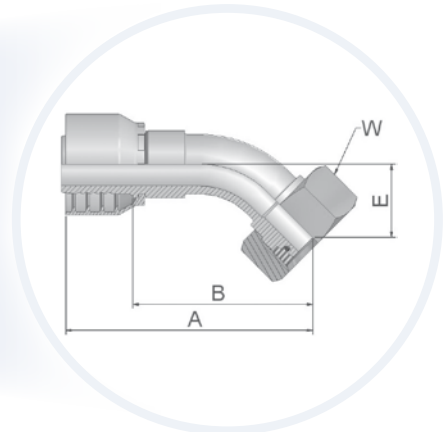
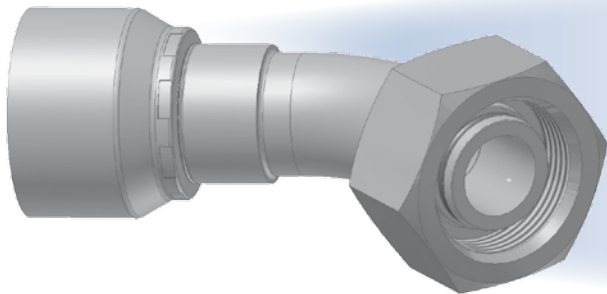

Approved fitting series for hose types:

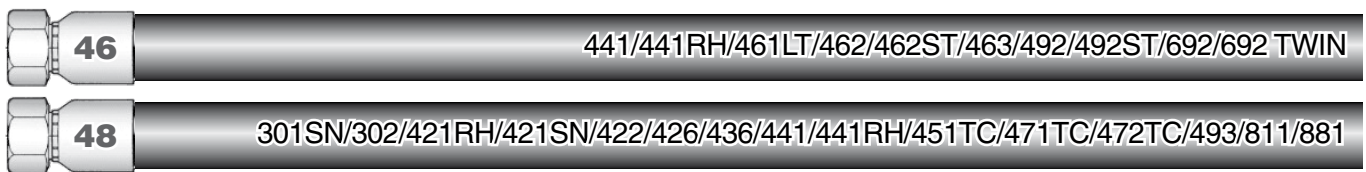

XXXX-XX-XX Part Number		Hose I.D.				Thread metric	Tube O.D.	A	B	E	W
46	48	DN	Inch	Size	mm						
10C46-6-4	10C48-6-4	6	1/4	-4	6,3	M14x1,5	6	61	37	17	17
10C46-8-4	10C48-8-4	6	1/4	-4	6,3	M16x1,5	8	59	35	16	19
10C46-10-4	10C48-10-4	6	1/4	-4	6,3	M18x1,5	10	59	35	16	22
10C46-12-4	10C48-12-4	6	1/4	-4	6,3	M20x1,5	12	72	48	17	24
10C46-10-5	10C48-10-5	8	5/16	-5	7,9	M18x1,5	10	62	38	17	22
10C46-12-5	10C48-12-5	8	5/16	-5	7,9	M20x1,5	12	71	47	17	24
10C46-10-6	10C48-10-6	10	3/8	-6	9,5	M18x1,5	10	70	47	19	22
10C46-12-6	10C48-12-6	10	3/8	-6	9,5	M20x1,5	12	69	46	20	24
10C46-14-6	10C48-14-6	10	3/8	-6	9,5	M22x1,5	14	69	46	20	27
10C46-14-8	10C48-14-8	12	1/2	-8	12,7	M22x1,5	14	70	46	22	27
10C46-16-8	10C48-16-8	12	1/2	-8	12,7	M24x1,5	16	72	49	23	30
10C46-16-10	10C48-16-10	16	5/8	-10	15,9	M24x1,5	16	78	52	24	30
10C46-20-10	10C48-20-10	16	5/8	-10	15,9	M30x2	20	77	51	25	36
10C46-20-12	10C48-20-12	20	3/4	-12	19,1	M30x2	20	91	65	28	36
10C46-25-12	10C48-25-12	20	3/4	-12	19,1	M36x2	25	91	65	29	46
10C46-25-16		25	1	-16	25,4	M36x2	25	110	80	33	46
	10C48-25-16	25	1	-16	25,4	M36x2	30	110	80	33	46
10C46-30-16	10C48-30-16	25	1	-16	25,4	M42x2	30	116	86	36	50
10C46-38-20°		32	1-1/4	-20	31,8	M52x2	38	136	98	38	60
	10C48-38-20°	32	1-1/4	-20	31,8	M52x2	38	142	95	38	60°

Hose fittings are delivered with ozone resistant Nitrile (NBR) O-ring as a standard version. Working temperature from -30 °C up to +105 °C.
 Hose fittings with special O-rings(Viton or EPDM) available on request. For O-ring dimensions and part-numbers see Section Eb.
 °Assembly only with Parkrimp 2 machine
 Material: steel chromium(VI) free plated

Information about standard products or non-standard products can be found in the current price list.
 Dimensions shown may be changed at any time without prior notice.

1C – Female Metric 24° – Heavy Series with O-ring – Swivel – 90° Elbow

ISO 12151-2-SWE-S – DKOS 90°

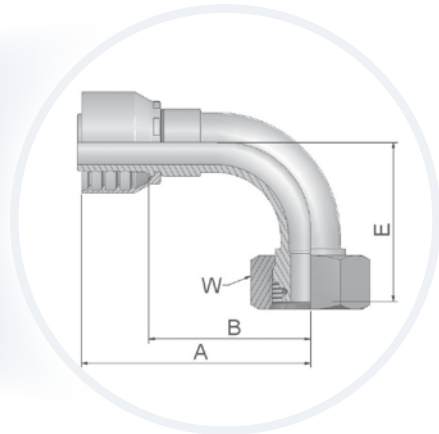
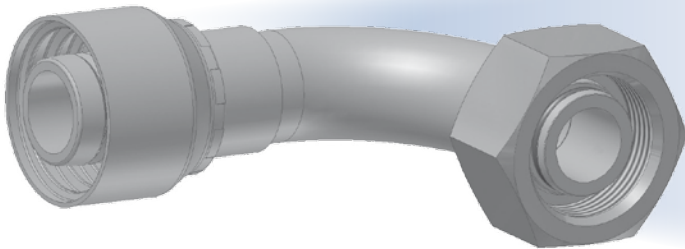

Approved fitting series for hose types:

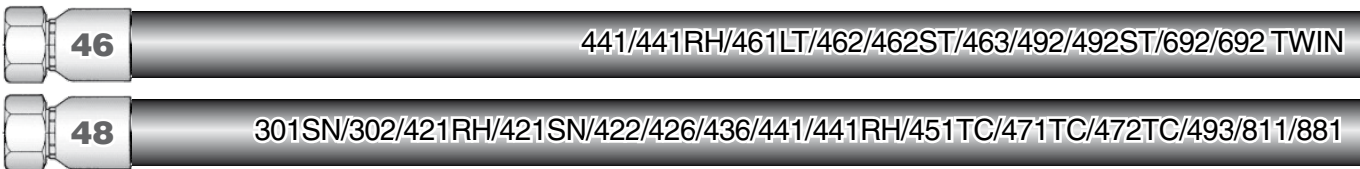

XXXX-XX-XX Part Number		Hose I.D.				Thread metric	Tube O.D.	A	B	E	W
46	48	DN	Inch	Size	mm						
11C46-6-4	11C48-6-4	6	1/4	-4	6,3	M14x1,5	6	62	38	32	17
11C46-8-4	11C48-8-4	6	1/4	-4	6,3	M16x1,5	8	50	26	29	19
11C46-10-4	11C48-10-4	6	1/4	-4	6,3	M18x1,5	10	50	26	29	22
11C46-12-4	11C48-12-4	6	1/4	-4	6,3	M20x1,5	12	62	38	31	24
11C46-10-5	11C48-10-5	8	5/16	-5	7,9	M18x1,5	10	60	36	31	22
11C46-12-5	11C48-12-5	8	5/16	-5	7,9	M20x1,5	12	60	36	32	24
11C46-10-6	11C48-10-6	10	3/8	-6	9,5	M18x1,5	10	59	36	36	22
11C46-12-6	11C48-12-6	10	3/8	-6	9,5	M20x1,5	12	58	35	37	24
11C46-14-6	11C48-14-6	10	3/8	-6	9,5	M22x1,5	14	58	35	37	27
11C46-14-8	11C48-14-8	12	1/2	-8	12,7	M22x1,5	14	62	38	42	27
11C46-16-8	11C48-16-8	12	1/2	-8	12,7	M24x1,5	16	61	37	45	30
11C46-16-10	11C48-16-10	16	5/8	-10	15,9	M24x1,5	16	66	41	48	30
11C46-20-10	11C48-20-10	16	5/8	-10	15,9	M30x2	20	65	40	48	36
11C46-20-12	11C48-20-12	20	3/4	-12	19,1	M30x2	20	80	54	58	36
11C46-25-10	11C48-25-10	16	5/8	-10	15,9	M36x2	25	65	40	52	46
11C46-25-12	11C48-25-12	20	3/4	-12	19,1	M36x2	25	80	54	59	46
11C46-25-16	11C48-25-16	25	1	-16	25,4	M36x2	25	102	72	71	46
11C46-30-16	11C48-30-16	25	1	-16	25,4	M42x2	30	105	75	75	50
11C46-38-20°		32	1-1/4	-20	31,8	M52x2	38	124	86	80	60
	11C48-38-20°	32	1-1/4	-20	31,8	M52x2	38	130	83	80	60

Hose fittings are delivered with ozone resistant Nitrile (NBR) O-ring as a standard version. Working temperature from -30 °C up to +105 °C.

Hose fittings with special O-rings (Viton or EPDM) available on request.

For O-ring dimensions and part-numbers see Section Eb.

Material: steel chromium(VI) free plated

°Assembly only with Parkrimp 2 machine

Information about standard products or non-standard products can be found in the current price list.
Dimensions shown may be changed at any time without prior notice.

D2 – Male Metric 24° – Heavy Series – Rigid – Straight

ISO 12151-2-S-S – CES

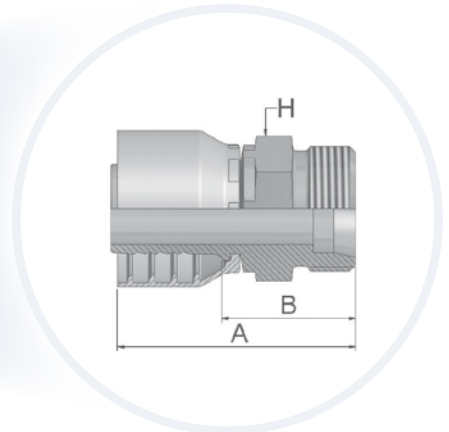
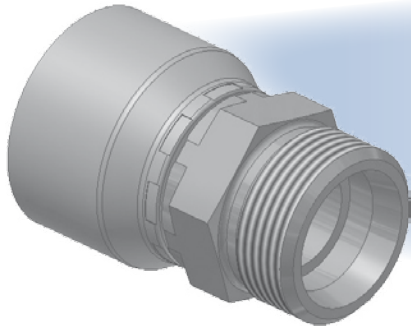

Approved fitting series for hose types:

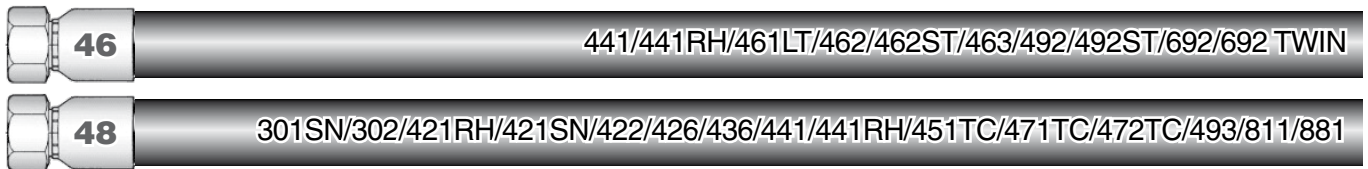

XXXX-XX-XX Part Number		Hose I.D.				Thread metric	Tube O.D. mm	A mm	B mm	H mm
46	48	DN	Inch	Size	mm					
1D246-6-4	1D248-6-4	6	1/4	-4	6,3	M14x1,5	6	48	24	14
1D246-8-4	1D248-8-4	6	1/4	-4	6,3	M16x1,5	8	48	24	17
1D246-10-4	1D248-10-4	6	1/4	-4	6,3	M18x1,5	10	50	26	19
1D246-12-4	1D248-12-4	6	1/4	-4	6,3	M20x1,5	12	49	26	22
1D246-8-5	1D248-8-5	8	5/16	-5	7,9	M16x1,5	8	48	24	17
1D246-10-5	1D248-10-5	8	5/16	-5	7,9	M18x1,5	10	50	26	19
1D246-12-5	1D248-12-5	8	5/16	-5	7,9	M20x1,5	12	50	26	22
1D246-14-5	1D248-14-5	8	5/16	-5	7,9	M22x1,5	14	51	28	22
1D246-10-6	1D248-10-6	10	3/8	-6	9,5	M18x1,5	10	50	27	19
1D246-12-6	1D248-12-6	10	3/8	-6	9,5	M20x1,5	12	49	26	22
1D246-14-6	1D248-14-6	10	3/8	-6	9,5	M22x1,5	14	51	28	22
1D246-12-8	1D248-12-8	12	1/2	-8	12,7	M20x1,5	12	50	26	22
1D246-16-8	1D248-16-8	12	1/2	-8	12,7	M24x1,5	16	53	29	24
1D246-16-10	1D248-16-10	16	5/8	-10	15,9	M24x1,5	16	56	31	24
1D246-20-10	1D248-20-10	16	5/8	-10	15,9	M30x2	20	58	32	30
1D246-20-12	1D248-20-12	20	3/4	-12	19,1	M30x2	20	61	35	30
1D246-25-12	1D248-25-12	20	3/4	-12	19,1	M36x2	25	64	38	36
1D246-25-16	1D248-25-16	25	1	-16	25,4	M36x2	25	69	39	36
1D246-30-16	1D248-30-16	25	1	-16	25,4	M42x2	30	72	42	46
1D246-38-20		32	1-1/4	-20	31,8	M52x2	38	84	46	55
	1D248-38-20	32	1-1/4	-20	31,8	M52x2	38	91	44	55

Material: steel chromium(VI) free plated

Information about standard products or non-standard products can be found in the current price list. Dimensions shown may be changed at any time without prior notice.

C6 – Female Metric – Heavy Series – Swivel – Straight (Ball Nose)

DKS

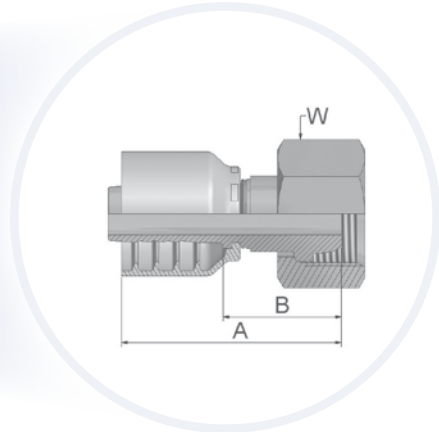
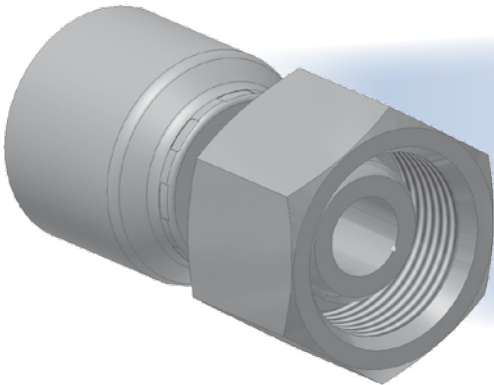

Approved fitting series for hose types:

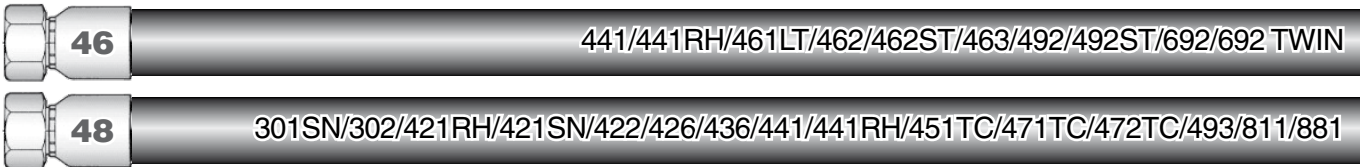

XXXX-XX-XX Part Number 46 48	Hose I.D.				Thread metric	Tube O.D. mm	A mm	B mm	W mm
	DN	Inch	Size	mm					
1C646-6-4	6	1/4	-4	6,3	M14x1,5	6	45	21	17
1C646-8-4	6	1/4	-4	6,3	M16x1,5	8	46	23	19
1C646-10-4	6	1/4	-4	6,3	M18x1,5	10	46	22	22
1C646-12-5	8	5/16	-5	7,9	M20x1,5	12	49	25	24
	10	3/8	-6	9,5	M20x1,5	12	48	25	24
1C646-14-6	10	3/8	-6	9,5	M22x1,5	14	47	24	27
1C646-16-8	12	1/2	-8	12,7	M24x1,5	16	51	28	30

Material: steel chromium(VI) free plated

Information about standard products or non-standard products can be found in the current price list. Dimensions shown may be changed at any time without prior notice.

3D – Metric Standpipe – Heavy Series – Rigid – Straight

ISO 8434-1 – BES

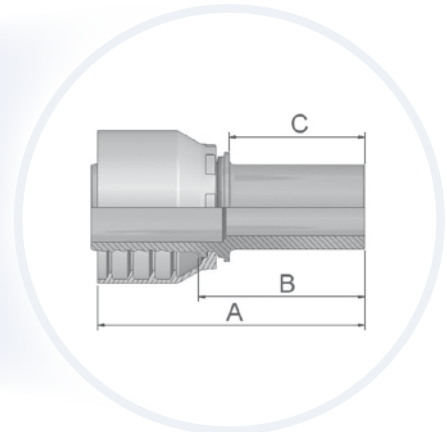
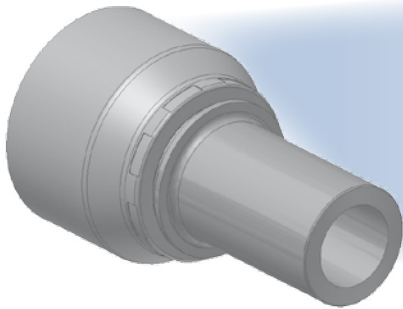

Approved fitting series for hose types:

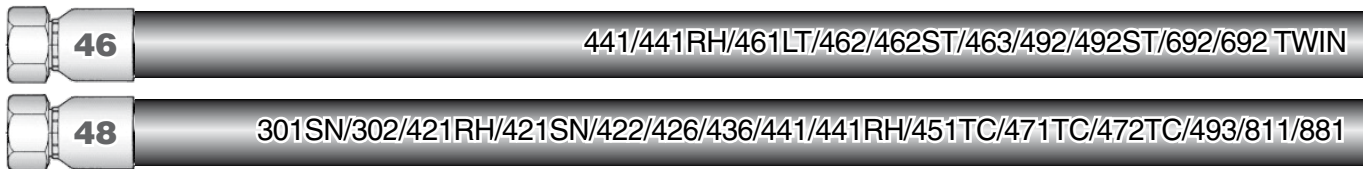

XXXX-XX-XX Part Number		 Hose I.D.				Tube O.D.	A	B	C
46	48	DN	Inch	Size	mm				
13D46-6-4	13D48-6-4	6	1/4	-4	6,3	6	56	32	24
13D46-8-4	13D48-8-4	6	1/4	-4	6,3	8	56	32	24
13D46-10-4	13D48-10-4	6	1/4	-4	6,3	10	58	34	26
13D46-12-5	13D48-12-5	8	5/16	-5	7,9	12	58	34	26
13D46-10-6	13D48-10-6	10	3/8	-6	9,5	10	57	34	26
13D46-12-6	13D48-12-6	10	3/8	-6	9,5	12	57	34	26
13D46-14-6	13D48-14-6	10	3/8	-6	9,5	14	60	37	29
13D46-16-8	13D48-16-8	12	1/2	-8	12,7	16	61	38	30
13D46-20-10	13D48-20-10	16	5/8	-10	15,9	20	69	44	36
13D46-20-12	13D48-20-12	20	3/4	-12	19,1	20	70	44	36
13D46-25-12	13D48-25-12	20	3/4	-12	19,1	25	74	48	40

Not recommended for new construction. Instead use C9. Should be used with cutting ring and nut.
Material: steel chromium(VI) free plated

Information about standard products or non-standard products can be found in the current price list.
Dimensions shown may be changed at any time without prior notice.

92 – Female BSP Parallel Pipe – Swivel – Straight (60° Cone)

BS5200-A – DKR

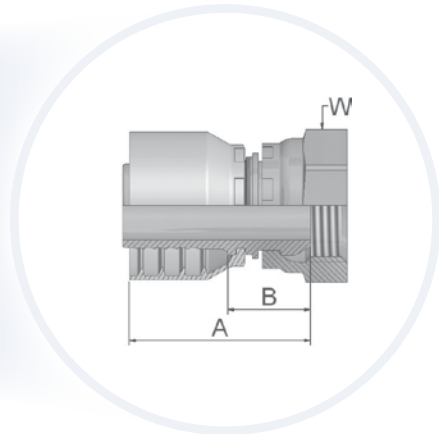
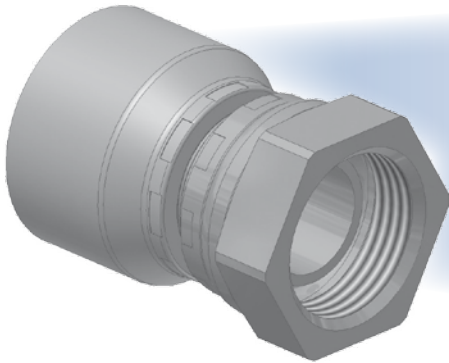

Approved fitting series for hose types:

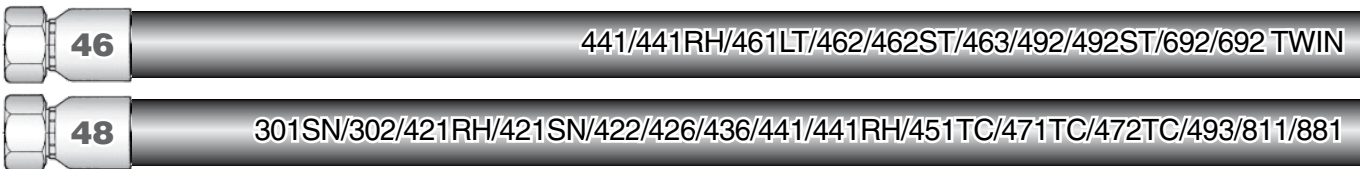

XXXX-XX-XX Part Number 46 48	Hose I.D.				Thread BSP	A mm	B mm	W mm	
	DN	Inch	Size	mm					
19246-2-4	19248-2-4	6	1/4	-4	6,3	1/8x28	41	17	14
19246-4-4	19248-4-4	6	1/4	-4	6,3	1/4x19	43	19	19
19246-6-4	19248-6-4	6	1/4	-4	6,3	3/8x19	44	20	22
19246-8-4	19248-8-4	6	1/4	-4	6,3	1/2x14	49	25	27
19246-4-5	19248-4-5	8	5/16	-5	7,9	1/4x19	43	19	19
19246-6-5	19248-6-5	8	5/16	-5	7,9	3/8x19	44	20	22
19246-4-6	19248-4-6	10	3/8	-6	9,5	1/4x19	43	20	19
19246-6-6	19248-6-6	10	3/8	-6	9,5	3/8x19	43	20	22
19246-8-6	19248-8-6	10	3/8	-6	9,5	1/2x14	45	22	27
19246-6-8	19248-6-8	12	1/2	-8	12,7	3/8x19	45	21	22
19246-8-8	19248-8-8	12	1/2	-8	12,7	1/2x14	46	22	27
19246-10-8	19248-10-8	12	1/2	-8	12,7	5/8x14	44	21	30
19246-12-8	19248-12-8	12	1/2	-8	12,7	3/4x14	47	23	32
19246-8-10	19248-8-10	16	5/8	-10	15,9	1/2x14	48	22	27
19246-10-10	19248-10-10	16	5/8	-10	15,9	5/8x14	46	20	30
19246-12-10	19248-12-10	16	5/8	-10	15,9	3/4x14	47	22	32
19246-8-12	19248-8-12	20	3/4	-12	19,1	1/2x14	49	23	27
19246-10-12	19248-10-12	20	3/4	-12	19,1	5/8x14	48	22	30
19246-12-12	19248-12-12	20	3/4	-12	19,1	3/4x14	49	23	32
19246-16-12	19248-16-12	20	3/4	-12	19,1	1x11	51	25	41
19246-16-16	19248-16-16	25	1	-16	25,4	1x11	55	25	41
19246-20-20		32	1-1/4	-20	31,8	1-1/4x11	68	31	50
	19248-20-20	32	1-1/4	-20	31,8	1-1/4x11	79	32	50
	19248-24-24	40	1-1/2	-24	38,1	1-1/2x11	71	33	60
	19248-24-24C	40	1-1/2	-24	38,1	1-1/2x11	71	33	60
	19248-32-32	50	2	-32	50,8	2x11	84	35	70
	19248-32-32C	50	2	-32	50,8	2x11	84	35	70

Material: steel chromium(VI) free plated

Information about standard products or non-standard products can be found in the current price list.
Dimensions shown may be changed at any time without prior notice.

B1 – Female BSP Parallel Pipe – Swivel – 45° Elbow (60° Cone)

BS 5200-D – DKR 45°

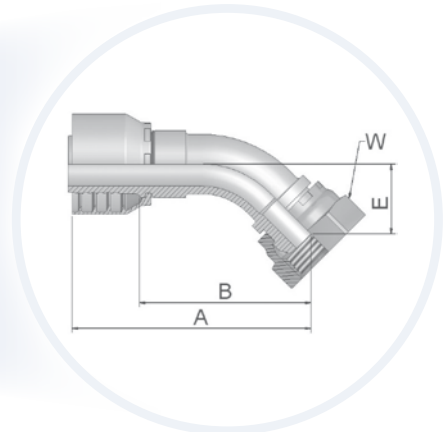
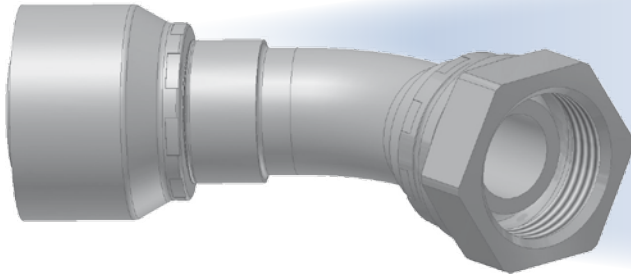

Approved fitting series for hose types:

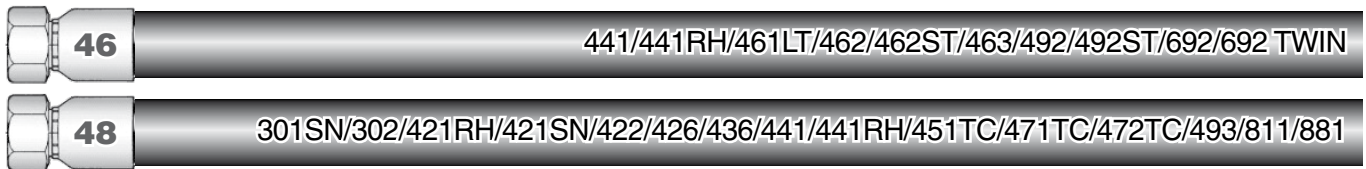

XXXX-XX-XX Part Number		Hose I.D.				Thread BSP	A mm	B mm	E mm	W mm
46	48	DN	Inch	Size	mm					
1B146-4-4	1B148-4-4	6	1/4	-4	6,3	1/4x19	59	35	16	19
1B146-6-4	1B148-6-4	6	1/4	-4	6,3	3/8x19	59	35	15	22
1B146-6-5	1B148-6-5	8	5/16	-5	7,9	3/8x19	60	36	15	22
1B146-6-6	1B148-6-6	10	3/8	-6	9,5	3/8x19	69	46	17	22
1B146-8-6	1B148-8-6	10	3/8	-6	9,5	1/2x14	63	40	17	27
1B146-6-8	1B148-6-8	12	1/2	-8	12,7	3/8x19	72	49	21	22
1B146-8-8	1B148-8-8	12	1/2	-8	12,7	1/2x14	72	48	20	27
1B146-10-8	1B148-10-8	12	1/2	-8	12,7	5/8x14	69	46	19	30
1B146-10-10	1B148-10-10	16	5/8	-10	15,9	5/8x14	78	53	22	30
1B146-12-10	1B148-12-10	16	5/8	-10	15,9	3/4x14	75	49	21	32
1B146-12-12	1B148-12-12	20	3/4	-12	19,1	3/4x14	87	61	25	32
1B146-16-12	1B148-16-12	20	3/4	-12	19,1	1x11	88	62	26	41
1B146-16-16	1B148-16-16	25	1	-16	25,4	1x11	106	76	31	41
1B146-20-20		32	1-1/4	-20	31,8	1-1/4x11	133	95	35	50
	1B148-20-20	32	1-1/4	-20	31,8	1-1/4x11	139	91	35	50
	1B148-24-24	40	1-1/2	-24	38,1	1-1/2x11	146	108	38	55
	1B148-32-32	50	2	-32	50,8	2x11	190	141	46	70

Material: steel chromium(VI) free plated

Information about standard products or non-standard products can be found in the current price list. Dimensions shown may be changed at any time without prior notice.

B2 – Female BSP Parallel Pipe – Swivel – 90° Elbow (60° Cone)

BS 5200-B – DKR 90

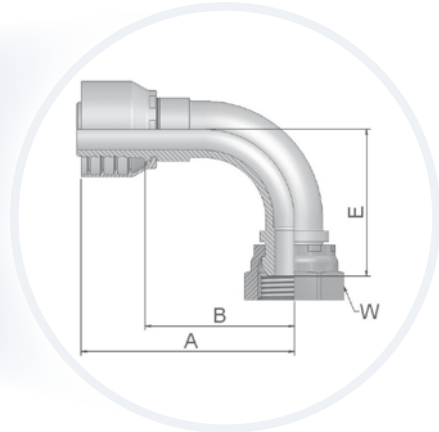
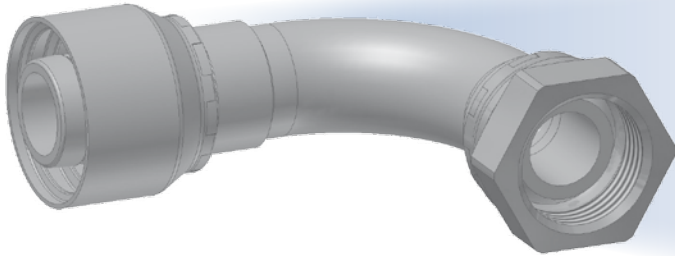

Approved fitting series for hose types:

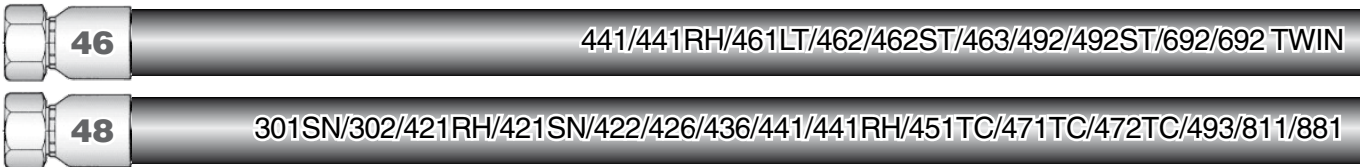

XXXX-XX-XX Part Number		Hose I.D.				Thread BSP	A mm	B mm	E mm	W mm
46	48	DN	Inch	Size	mm					
1B246-2-4	1B248-2-4	6	1/4	-4	6,3	1/8x28	50	26	28	14
1B246-4-4	1B248-4-4	6	1/4	-4	6,3	1/4x19	50	26	29	19
1B246-6-4	1B248-6-4	6	1/4	-4	6,3	3/8x19	51	28	27	22
1B246-8-4	1B248-8-4	6	1/4	-4	6,3	1/2x14	51	27	29	27
1B246-6-5	1B248-6-5	8	5/16	-5	7,9	3/8x19	52	28	28	22
1B246-6-6	1B248-6-6	10	3/8	-6	9,5	3/8x19	61	38	33	22
1B246-8-6	1B248-8-6	10	3/8	-6	9,5	1/2x14	60	38	36	27
1B246-6-8	1B248-6-8	12	1/2	-8	12,7	3/8x19	63	40	41	22
1B246-8-8	1B248-8-8	12	1/2	-8	12,7	1/2x14	63	40	41	27
1B246-10-8	1B248-10-8	12	1/2	-8	12,7	5/8x14	67	43	39	30
1B246-10-10	1B248-10-10	16	5/8	-10	15,9	5/8x14	70	45	44	30
1B246-12-10	1B248-12-10	16	5/8	-10	15,9	3/4x14	70	45	42	32
1B246-12-12	1B248-12-12	20	3/4	-12	19,1	3/4x14	80	54	53	32
1B246-16-12	1B248-16-12	20	3/4	-12	19,1	1x11	80	54	54	41
1B246-16-16	1B248-16-16	25	1	-16	25,4	1x11	105	75	69	41
1B246-20-20		32	1-1/4	-20	31,8	1-1/4x11	124	86	76	50
	1B248-20-20	32	1-1/4	-20	31,8	1-1/4x11	130	82	76	50
	1B248-20-20C	32	1-1/4	-20	31,8	1-1/4x11	130	82	76	50
	1B248-24-24	40	1-1/2	-24	38,1	1-1/2x11	140	102	86	55
	1B248-32-32	50	2	-32	50,8	2x11	185	137	106	70

Material: steel chromium(VI) free plated

Information about standard products or non-standard products can be found in the current price list. Dimensions shown may be changed at any time without prior notice.

B4 – Female BSP Parallel Pipe – Swivel – 90° Elbow Block Type (60° Cone)

BS 5200-E

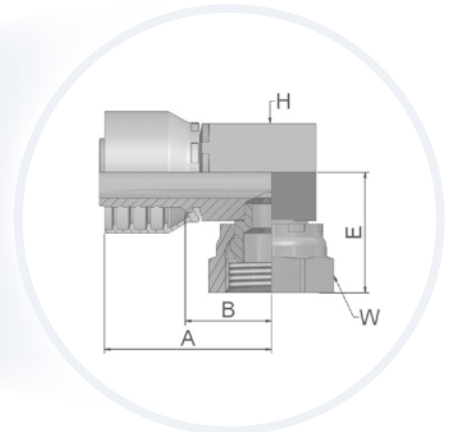
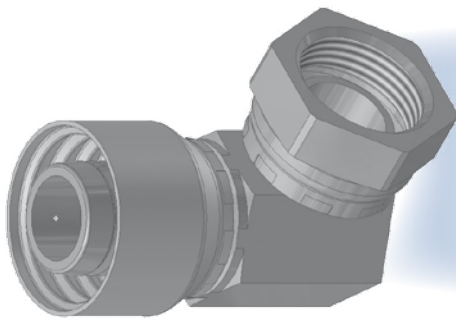

Approved fitting series for hose types:

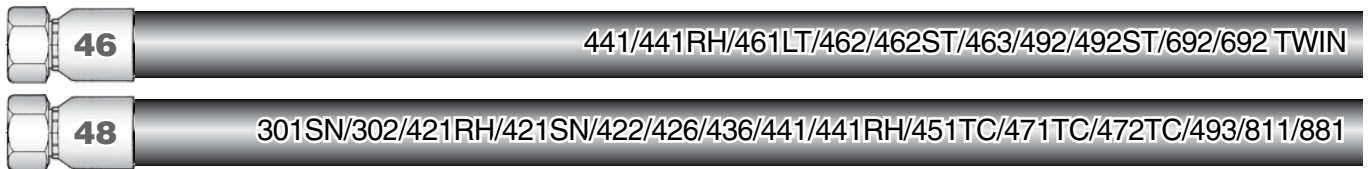

XXXX-XX-XX Part Number		Hose I.D.				Thread BSP	A mm	B mm	E mm	H mm	W mm
46	48	DN	Inch	Size	mm						
1B446-4-4	1B448-4-4	6	1/4	-4	6,3	1/4x19	58	34	22	17	19
1B446-6-4	1B448-6-4	6	1/4	-4	6,3	3/8x19	43	20	22	17	22
1B446-6-6	1B448-6-6	10	3/8	-6	9,5	3/8x19	68	45	23	19	22
1B446-8-6	1B448-8-6	10	3/8	-6	9,5	1/2x14	67	44	27	22	27
1B446-8-8	1B448-8-8	12	1/2	-8	12,7	1/2x14	67	44	27	22	27
1B446-10-10	1B448-10-10	16	5/8	-10	15,9	5/8x14	70	45	27	27	30
1B446-12-10	1B448-12-10	16	5/8	-10	15,9	3/4x14	71	46	33	32	32
1B446-12-12	1B448-12-12	20	3/4	-12	19,1	3/4x14	73	47	33	32	32
1B446-16-16	1B448-16-16	25	1	-16	25,4	1x11	82	52	45	36	41

Short version available upon request (swaging on universal crimpers only)
Material: steel chromium(VI) free plated

Information about standard products or non-standard products can be found in the current price list.
Dimensions shown may be changed at any time without prior notice.

EA – BSP Swivel Female with O-ring (60° Cone)

BS 5200 – ISO 12151-6 – DKOR

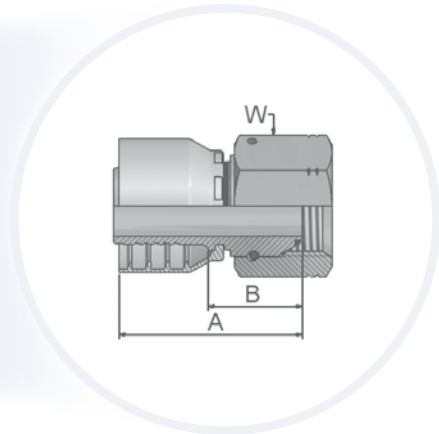
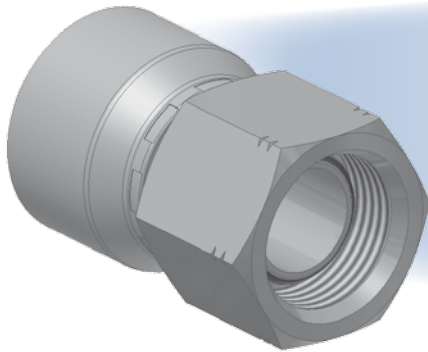

Approved fitting series for hose types:

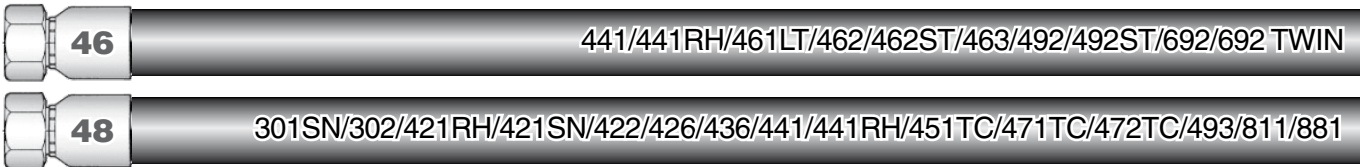

XXXX-XX-XX Part Number 46 48	Hose I.D.				Thread BSP	A mm	B mm	W mm	
	DN	Inch	Size	mm					
1EA46-4-4	1EA48-4-4	6	1/4	-4	6,3	1/4x19	45	21	19
1EA46-6-4	1EA48-6-4	6	1/4	-4	6,3	3/8x19	49	26	22
1EA46-6-6	1EA48-6-6	10	3/8	-6	9,5	3/8x19	48	26	22
1EA46-8-6	1EA48-8-6	10	3/8	-6	9,5	1/2x14	51	28	27
1EA46-8-8	1EA48-8-8	12	1/2	-8	12,7	1/2x14	52	28	27
1EA46-10-10	1EA48-10-10	16	5/8	-10	15,9	5/8x14	47	21	30
1EA46-12-10	1EA48-12-10	16	5/8	-10	15,9	3/4x14	54	29	32
1EA46-12-12	1EA48-12-12	20	3/4	-12	19,1	3/4x14	50	24	32
1EA46-16-12	1EA48-16-12	20	3/4	-12	19,1	1x11	61	35	41
1EA46-16-16	1EA48-16-16	25	1	-16	25,4	1x11	62	32	41
	1EA48-20-20	32	1-1/4	-20	31,8	1-1/4x11	78	31	50

Hose fittings are delivered with ozone resistant Nitrile (NBR) O-ring as a standard version. Working temperature from -30 °C up to +105 °C.
 Hose fittings with special O-rings (Viton or EPDM) available on request.
 For O-ring dimensions and part-numbers see Section Eb.
 Material: steel chromium(VI) free plated

Information about standard products or non-standard products can be found in the current price list.
 Dimensions shown may be changed at any time without prior notice.

EB – BSP Swivel Female with O-ring – 45° Elbow (60° Cone)

BS 5200 – ISO 12151-6 – DKOR 45°

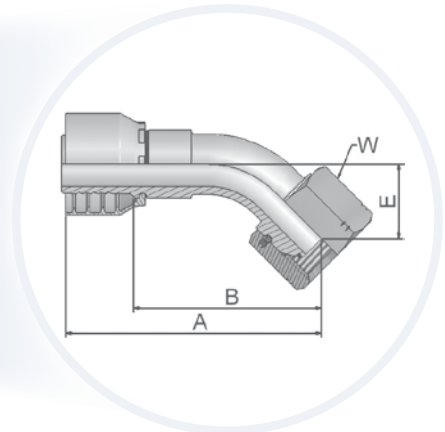
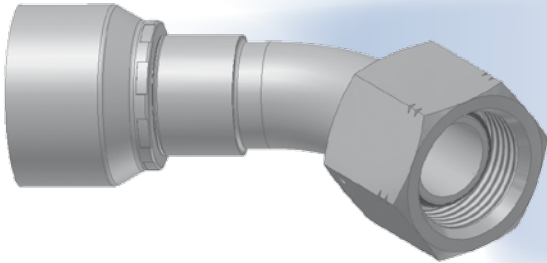

Approved fitting series for hose types:

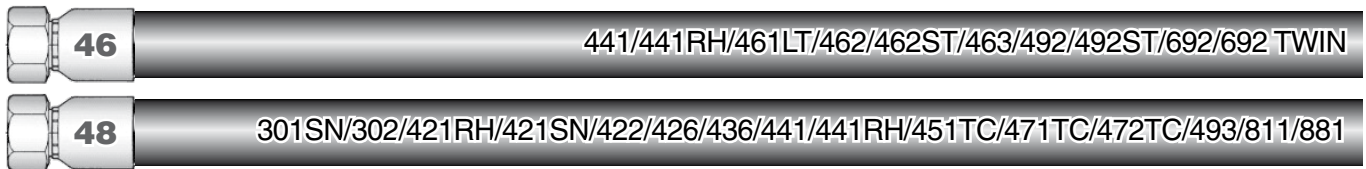

XXXX-XX-XX Part Number		Hose I.D.				Thread BSP	A	B	E	W
46	48	DN	Inch	Size	mm		mm	mm	mm	mm
1EB46-4-4	1EB48-4-4	6	1/4	-4	6,3	1/4x19	59	35	16	19
1EB46-6-6	1EB48-6-6	10	3/8	-6	9,5	3/8x19	69	46	17	22
1EB46-8-8	1EB48-8-8	12	1/2	-8	12,7	1/2x14	72	48	20	27
1EB46-12-10	1EB48-12-10	16	5/8	-10	15,9	3/4x14	78	52	21	32
1EB46-12-12	1EB48-12-12	20	3/4	-12	19,1	3/4x14	89	63	27	32
1EB46-16-16	1EB48-16-16	25	1	-16	25,4	1x11	113	83	33	41

Hose fittings are delivered with ozone resistant Nitrile (NBR) O-ring as a standard version. Working temperature from -30 °C up to +105 °C.
 Hose fittings with special O-rings (Viton or EPDM) available on request.
 For O-ring dimensions and part-numbers see Section Eb.
 Material: steel chromium(VI) free plated

Information about standard products or non-standard products can be found in the current price list.
 Dimensions shown may be changed at any time without prior notice.

EC – BSP Swivel Female with O-ring – 90° Elbow (60° Cone)

BS 5200 – ISO 12151-6 – DKOR 90°

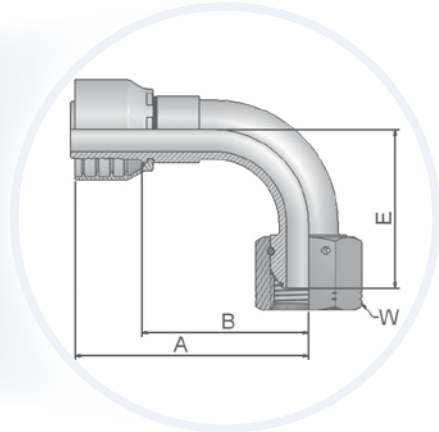
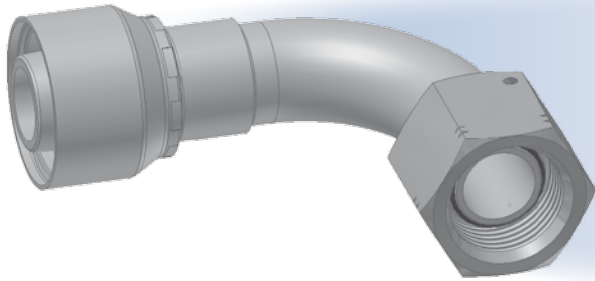

Approved fitting series for hose types:

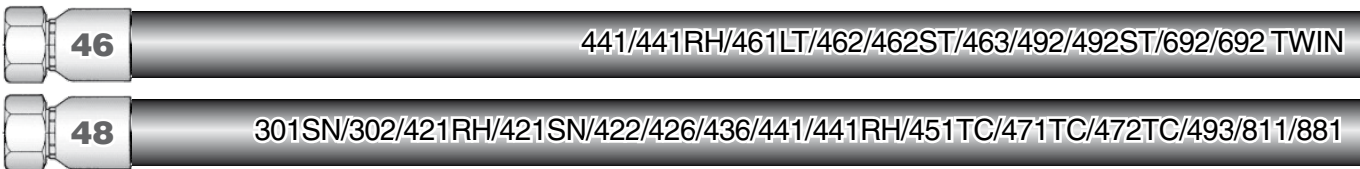

XXXX-XX-XX Part Number 46 48	Hose I.D. DN Inch Size mm				Thread BSP	A mm	B mm	E mm	W mm	
	DN	Inch	Size	mm						
1EC46-4-4	1EC48-4-4	6	1/4	-4	6,3	1/4x19	50	26	28	19
1EC46-6-6	1EC48-6-6	10	3/8	-6	9,5	3/8x19	61	38	33	22
1EC46-8-6	1EC48-8-6	10	3/8	-6	9,5	1/2x14	60	38	36	27
1EC46-8-8	1EC48-8-8	12	1/2	-8	12,7	1/2x14	63	40	40	27
1EC46-10-8	1EC48-10-8	12	1/2	-8	12,7	5/8x14	63	40	39	30
1EC46-10-10	1EC48-10-10	16	5/8	-10	15,9	5/8x14	70	45	44	30
1EC46-12-10	1EC48-12-10	16	5/8	-10	15,9	3/4x14	70	45	42	32
1EC46-12-12	1EC48-12-12	20	3/4	-12	19,1	3/4x14	80	54	55	32
1EC46-16-12	1EC48-16-12	20	3/4	-12	19,1	1x11	80	54	59	41
1EC46-16-16	1EC48-16-16	25	1	-16	25,4	1x11	105	75	71	41
	1EC48-20-20	32	1.1/4	-20	31,8	1-1/4x11	130	82	76	50

Hose fittings are delivered with ozone resistant Nitrile (NBR) O-ring as a standard version. Working temperature from -30 °C up to +105 °C.
Hose fittings with special O-rings (Viton or EPDM) available on request.
For O-ring dimensions and part-numbers see Section Eb.
Material: steel chromium(VI) free plated

Information about standard products or non-standard products can be found in the current price list.
Dimensions shown may be changed at any time without prior notice.

D9 – Male BSP Parallel Pipe – Rigid – Straight (60° Cone)

BS5200 – AGR

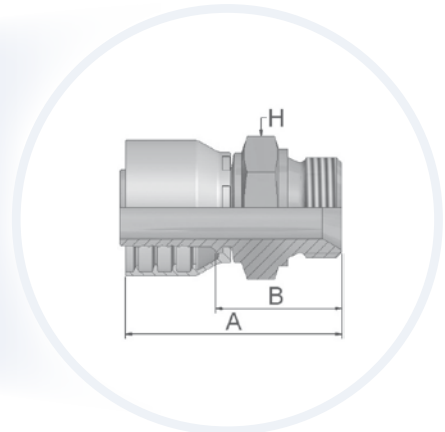
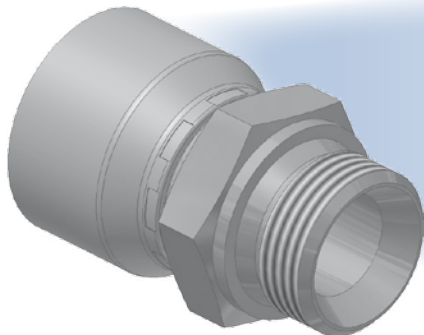

Approved fitting series for hose types:

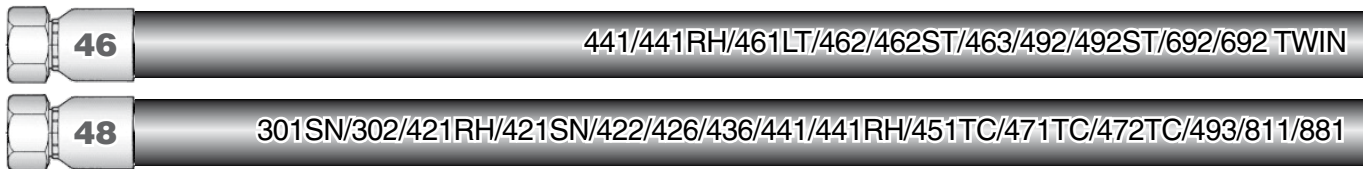

XXXX-XX-XX Part Number		Hose I.D.				Thread BSP	A	B	H
46	48	DN	Inch	Size	mm		mm	mm	mm
1D946-2-4	1D948-2-4	6	1/4	-4	6,3	1/8x28	46	22	14
1D946-4-4	1D948-4-4	6	1/4	-4	6,3	1/4x19	51	27	19
1D946-6-4	1D948-6-4	6	1/4	-4	6,3	3/8x19	53	31	22
1D946-8-4	1D948-8-4	6	1/4	-4	6,3	1/2x14	56	33	27
1D946-4-5	1D948-4-5	8	5/16	-5	7,9	1/4x19	51	27	19
1D946-6-5	1D948-6-5	8	5/16	-5	7,9	3/8x19	55	31	22
1D946-4-6	1D948-4-6	10	3/8	-6	9,5	1/4x19	50	27	19
1D946-6-6	1D948-6-6	10	3/8	-6	9,5	3/8x19	54	31	22
1D946-8-6	1D948-8-6	10	3/8	-6	9,5	1/2x14	56	33	27
1D946-6-8	1D948-6-8	12	1/2	-8	12,7	3/8x19	54	30	22
1D946-8-8	1D948-8-8	12	1/2	-8	12,7	1/2x14	57	33	27
1D946-10-8	1D948-10-8	12	1/2	-8	12,7	5/8x14	59	35	30
1D946-12-8	1D948-12-8	12	1/2	-8	12,7	3/4x14	60	36	32
1D946-8-10	1D948-8-10	16	5/8	-10	15,9	1/2x14	59	33	27
1D946-10-10	1D948-10-10	16	5/8	-10	15,9	5/8x14	61	36	30
1D946-12-10	1D948-12-10	16	5/8	-10	15,9	3/4x14	62	37	32
1D946-12-12	1D948-12-12	20	3/4	-12	19,1	3/4x14	62	36	32
1D946-16-12	1D948-16-12	20	3/4	-12	19,1	1x11	68	42	41
1D946-16-16	1D948-16-16	25	1	-16	25,4	1x11	72	42	41
1D946-20-20		32	1-1/4	-20	31,8	1-1/4x11	85	47	50
	1D948-20-20	32	1-1/4	-20	31,8	1-1/4x11	92	45	50
	1D948-24-24	40	1-1/2	-24	38,1	1-1/2x11	87	49	60
	1D948-24-24C	40	1-1/2	-24	38,1	1-1/2x11	87	49	60
	1D948-32-32	50	2	-32	50,8	2	102	54	70

Material: steel chromium(VI) free plated

Information about standard products or non-standard products can be found in the current price list. Dimensions shown may be changed at any time without prior notice.

91 – Male BSP Taper Pipe – Rigid – Straight

BS5200 – AGR-K

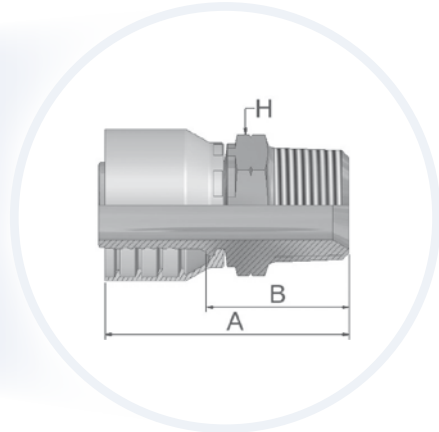
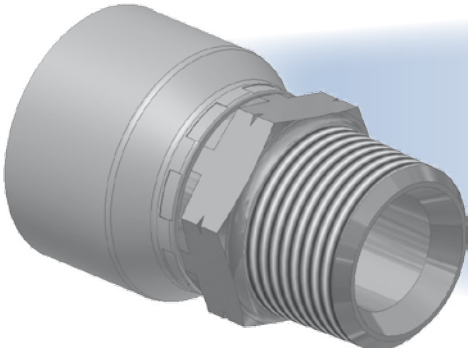

Approved fitting series for hose types:

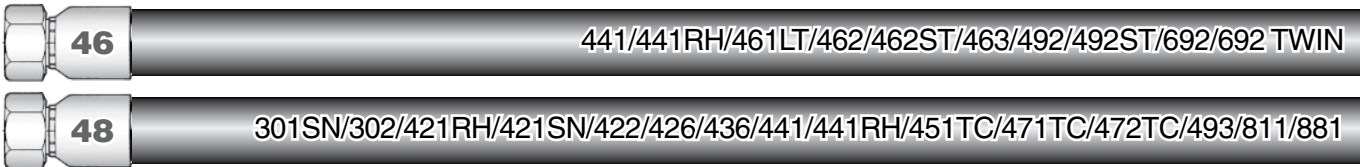

XXXX-XX-XX Part Number		Hose I.D.				Thread BSP	A mm	B mm	H mm
46	48	DN	Inch	Size	mm				
19146-4-4	19148-4-4	6	1/4	-4	6,3	1/4x19	49	26	14
19146-6-4	19148-6-4	6	1/4	-4	6,3	3/8x19	51	28	17
19146-4-5	19148-4-5	8	5/16	-5	7,9	1/4x19	48	24	14
19146-6-5	19148-6-5	8	5/16	-5	7,9	3/8x19	51	28	17
19146-4-6	19148-4-6	10	3/8	-6	9,5	1/4x19	47	24	14
19146-6-6	19148-6-6	10	3/8	-6	9,5	3/8x19	52	28	17
19146-8-6	19148-8-6	10	3/8	-6	9,5	1/2x14	57	34	22
19146-6-8	19148-6-8	12	1/2	-8	12,7	3/8x19	48	25	17
19146-8-8	19148-8-8	12	1/2	-8	12,7	1/2x14	57	33	22
19146-12-10	19148-12-10	16	5/8	-10	15,9	3/4x14	63	38	27
19146-12-12	19148-12-12	20	3/4	-12	19,1	3/4x14	63	37	27
19146-16-16	19148-16-16	25	1	-16	25,4	1x11	72	42	36

Material: steel chromium(VI) free plated

Information about standard products or non-standard products can be found in the current price list. Dimensions shown may be changed at any time without prior notice.

B5 – Female BSP Parallel Pipe – Swivel – Straight (Flat Seat)

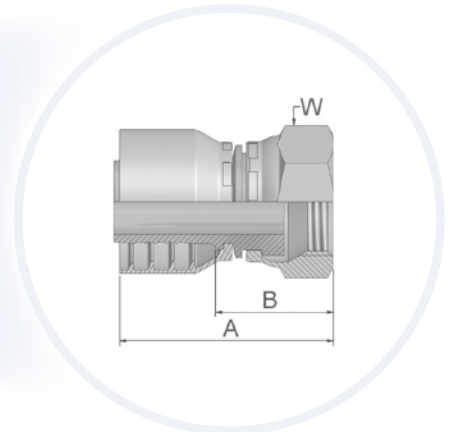
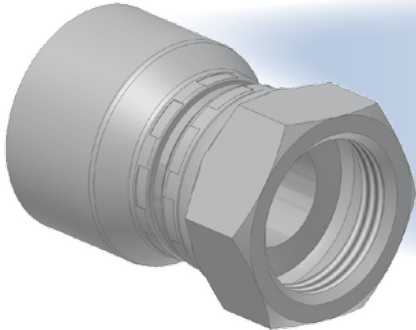

Approved fitting series for hose types:

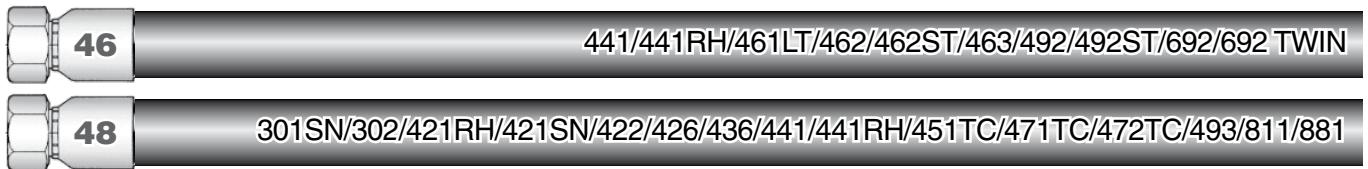

XXXX-XX-XX Part Number		Hose I.D.				Thread BSP	A	B	W
46	48	DN	Inch	Size	mm		mm	mm	mm
1B546-4-4	1B548-4-4	6	1/4	-4	6,3	1/4x19	41	17	19
1B546-4-5	1B548-4-5	8	5/16	-5	7,9	1/4x19	41	17	19
1B546-6-5	1B548-6-5	8	5/16	-5	7,9	3/8x19	38	14	22
1B546-8-5	1B548-8-5	8	5/16	-5	7,9	1/2x14	44	21	27
1B546-6-6	1B548-6-6	10	3/8	-6	9,5	3/8x19	37	14	22
1B546-8-6	1B548-8-6	10	3/8	-6	9,5	1/2x14	43	20	27
1B546-8-8	1B548-8-8	12	1/2	-8	12,7	1/2x14	43	19	27
1B546-12-8	1B548-12-8	12	1/2	-8	12,7	3/4x14	43	19	32
1B546-12-10	1B548-12-10	16	5/8	-10	15,9	3/4x14	43	18	32
1B546-12-12	1B548-12-12	20	3/4	-12	19,1	3/4x14	44	18	32
1B546-16-16	1B548-16-16	25	1	-16	25,4	1x11	51	22	41

Material: steel chromium(VI) free plated

Information about standard products or non-standard products can be found in the current price list. Dimensions shown may be changed at any time without prior notice.

01 – Male NPTF Pipe – Rigid – Straight

SAE J476A – J516 – AGN

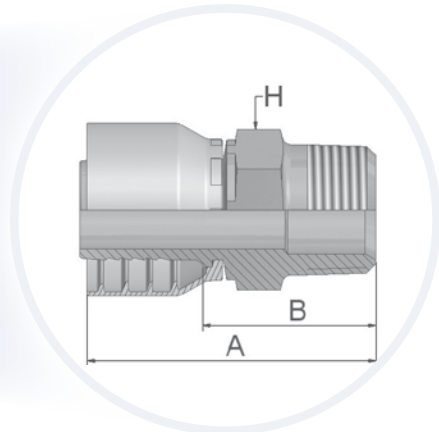
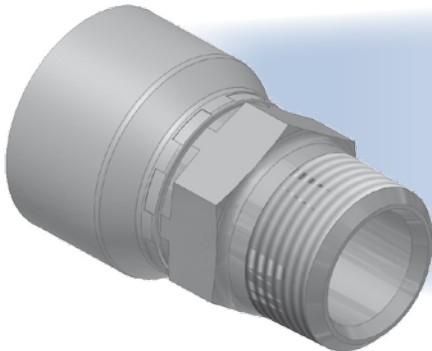

Approved fitting series for hose types:

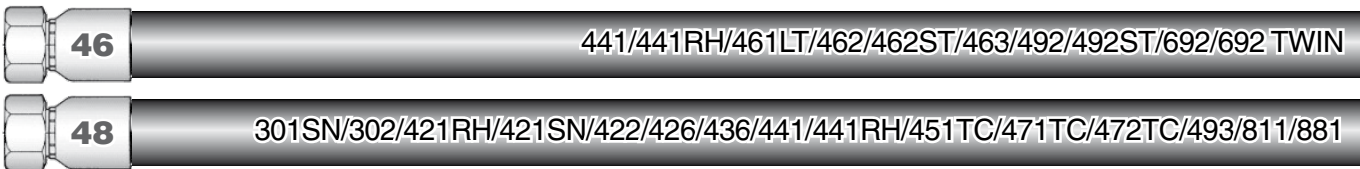

XXXX-XX-XX Part Number		Hose I.D.				Thread NPTF	A mm	B mm	H mm
46	48	DN	Inch	Size	mm				
10146-2-4	10148-2-4	6	1/4	-4	6,3	1/8x27	47	23	12
10146-4-4	10148-4-4	6	1/4	-4	6,3	1/4x18	53	29	14
10146-6-4	10148-6-4	6	1/4	-4	6,3	3/8x18	55	31	19
10146-4-5	10148-4-5	8	5/16	-5	7,9	1/4x18	53	29	14
10146-6-5	10148-6-5	8	5/16	-5	7,9	3/8x18	55	31	19
10146-4-6	10148-4-6	10	3/8	-6	9,5	1/4x18	52	29	14
10146-6-6	10148-6-6	10	3/8	-6	9,5	3/8x18	54	31	19
10146-8-6	10148-8-6	10	3/8	-6	9,5	1/2x14	55	32	22
10146-6-8	10148-6-8	12	1/2	-8	12,7	3/8x18	55	32	19
10146-8-8	10148-8-8	12	1/2	-8	12,7	1/2x14	62	38	22
10146-8-10	10148-8-10	16	5/8	-10	15,9	1/2x14	63	38	22
10146-12-10	10148-12-10	16	5/8	-10	15,9	3/4x14	59	34	27
10146-12-12	10148-12-12	20	3/4	-12	19,1	3/4x14	60	34	27
10146-16-16	10148-16-16	25	1	-16	25,4	1x11-1/2	75	45	36
10146-20-20		32	1-1/4	-20	31,8	1-1/4x11-1/2	86	48	46
	10148-20-20	32	1-1/4	-20	31,8	1-1/4x11-1/2	104	57	46
	10148-24-24	40	1-1/2	-24	38,1	1-1/2x11-1/2	89	51	50
	10148-32-32	50	2	-32	50,8	2x11-1/2	104	55	65

Material: steel chromium(VI) free plated

Information about standard products or non-standard products can be found in the current price list. Dimensions shown may be changed at any time without prior notice.

03 – Male JIC 37° – Rigid – Straight

ISO12151-5-S – AGJ

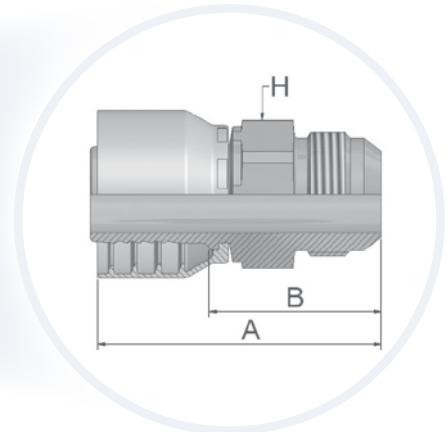
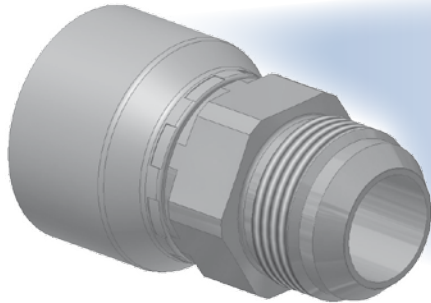

Approved fitting series for hose types:

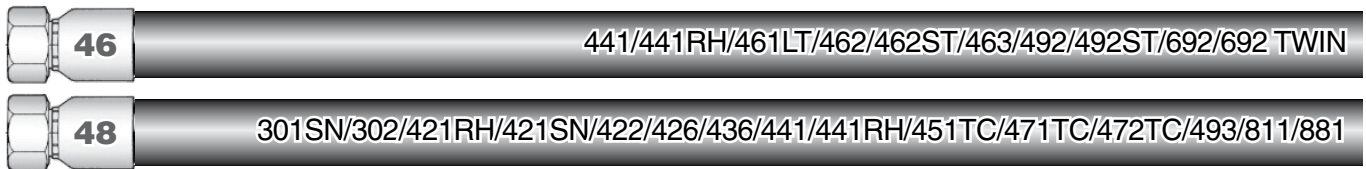

XXXX-XX-XX Part Number		Hose I.D.				Thread UNF	A	B	H
46	48	DN	Inch	Size	mm		mm	mm	mm
10346-4-4	10348-4-4	6	1/4	-4	6,3	7/16x20	52	29	14
10346-5-4	10348-5-4	6	1/4	-4	6,3	1/2x20	52	29	14
10346-6-4	10348-6-4	6	1/4	-4	6,3	9/16x18	55	31	19
10346-5-5	10348-5-5	8	5/16	-5	7,9	1/2x20	50	26	14
10346-6-5	10348-6-5	8	5/16	-5	7,9	9/16x18	55	31	19
10346-8-5	10348-8-5	8	5/16	-5	7,9	3/4x16	57	33	19
10346-4-6	10348-4-6	10	3/8	-6	9,5	7/16x20	54	31	19
10346-5-6	10348-5-6	10	3/8	-6	9,5	1/2x20	53	30	19
10346-6-6	10348-6-6	10	3/8	-6	9,5	9/16x18	54	31	19
10346-8-6	10348-8-6	10	3/8	-6	9,5	3/4x16	53	30	22
10346-10-6	10348-10-6	10	3/8	-6	9,5	7/8x14	56	33	24
10346-8-8	10348-8-8	12	1/2	-8	12,7	3/4x16	58	34	22
10346-10-8	10348-10-8	12	1/2	-8	12,7	7/8x14	56	32	24
10346-12-8	10348-12-8	12	1/2	-8	12,7	1-1/16x12	62	38	27
10346-8-10	10348-8-10	16	5/8	-10	15,9	3/4x16	57	31	22
10346-10-10	10348-10-10	16	5/8	-10	15,9	7/8x14	63	38	24
10346-12-10	10348-12-10	16	5/8	-10	15,9	1-1/16x12	64	39	27
10346-12-12	10348-12-12	20	3/4	-12	19,1	1-1/16x12	68	42	27
10346-14-12	10348-14-12	20	3/4	-12	19,1	1-3/16x12	68	42	30
10346-16-12	10348-16-12	20	3/4	-12	19,1	1-5/16x12	64	38	36
10346-16-16	10348-16-16	25	1	-16	25,4	1-5/16x12	76	46	36
10346-20-16	10348-20-16	25	1	-16	25,4	1-5/8x12	73	43	46
10346-20-20		32	1-1/4	-20	31,8	1-5/8x12	86	48	46
	10348-20-20	32	1-1/4	-20	31,8	1-5/8x12	101	53	46
	10348-24-24	40	1-1/2	-24	38,1	1-7/8x12	85	47	50
	10348-32-32	50	2	-32	50,8	2-1/2x12	109	61	65

Material: steel chromium(VI) free plated

Information about standard products or non-standard products can be found in the current price list. Dimensions shown may be changed at any time without prior notice.

04 – Male SAE 45° – Rigid – Straight

SAE J516

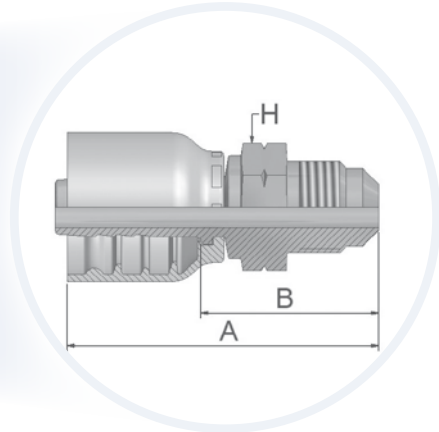
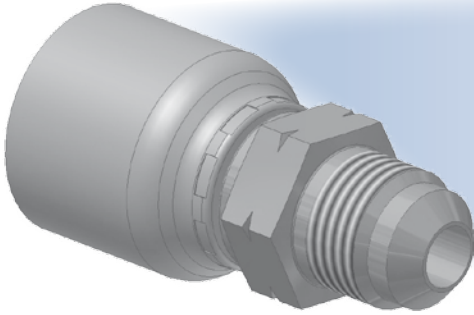

Approved fitting series for hose types:

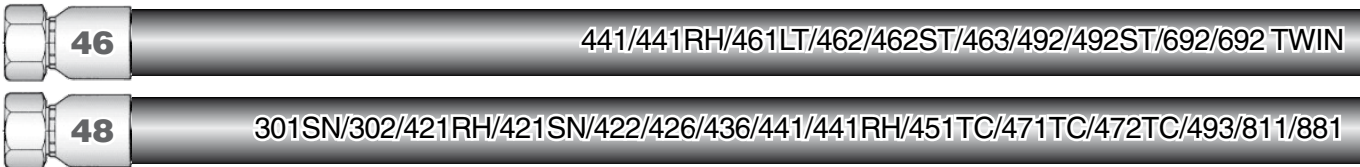

XXXX-XX-XX Part Number		Hose I.D.				Thread UNF	A	B	H
46	48	DN	Inch	Size	mm		mm	mm	mm
10446-6-6	10448-6-6	10	3/8	-6	9,5	5/8x18	54	31	19

Material: steel chromium(VI) free plated

Information about standard products or non-standard products can be found in the current price list. Dimensions shown may be changed at any time without prior notice.

05 – Male SAE Straight Thread with O-ring – Rigid – Straight

ISO 11926 – SAE J516

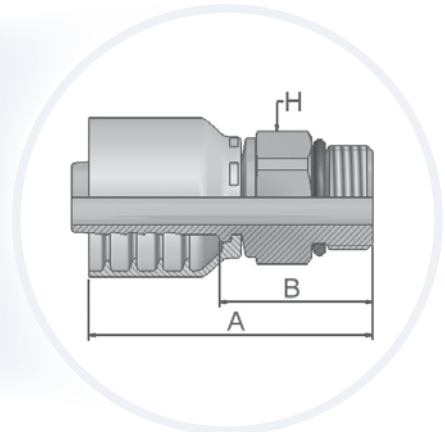
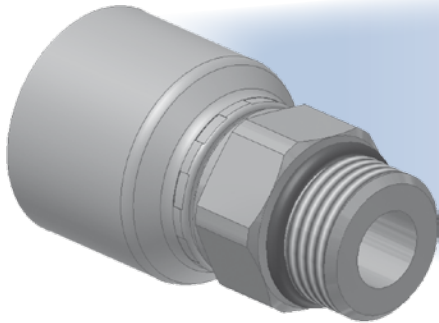

Approved fitting series for hose types:

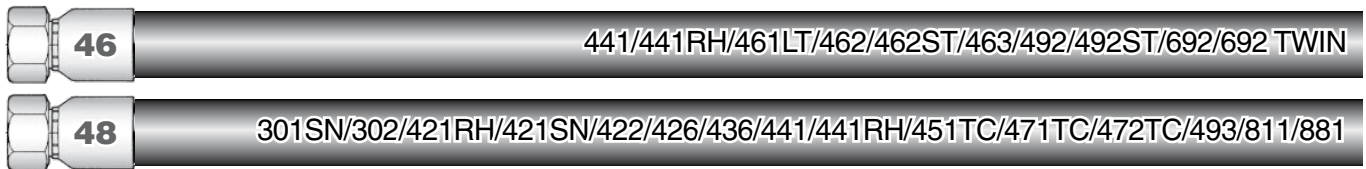

XXXX-XX-XX Part Number		Hose I.D.				Thread UNF	A mm	B mm	H mm
46	48	DN	Inch	Size	mm				
10546-6-6	10548-6-6	10	3/8	-6	9,5	9/16-18	48	25	17
10546-8-6	10548-8-6	10	3/8	-6	9,5	3/4x16	48	25	22
10546-8-8	10548-8-8	12	1/2	-8	12,7	3/4x16	52	28	22
10546-10-8	10548-10-8	12	1/2	-8	12,7	7/8x14	49	26	27

To select corresponding O-ring see Section Eb.
Material: steel chromium(VI) free plated

Information about standard products or non-standard products can be found in the current price list.
Dimensions shown may be changed at any time without prior notice.

06/68 – Female – JIC 37° / SAE 45° Dual Flare – Swivel – Straight

ISO12151-5-SWS – DKJ

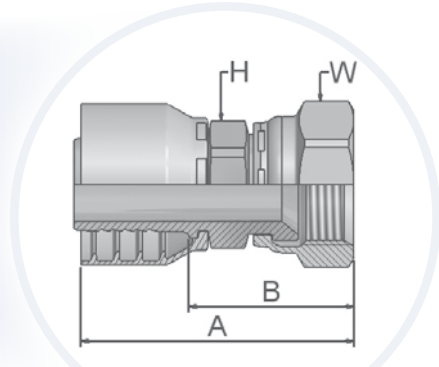
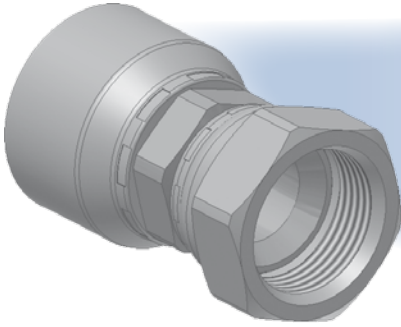

Approved fitting series for hose types:



XXXX-XX-XX Part Number		 Hose I.D.				 Thread UNF	A	B	 H	 W
46	48	DN	Inch	Size	mm		mm	mm	mm	mm
16846-4-4	16848-4-4	6	1/4	-4	6,3	7/16x20	52	29	14	17
16846-5-4	16848-5-4	6	1/4	-4	6,3	1/2x20	53	30	14	17
10646-6-4	10648-6-4	6	1/4	-4	6,3	9/16x18	55	31	14	19
16846-5-5	16848-5-5	8	5/16	-5	7,9	1/2x20	54	30	14	17
10646-6-5	10648-6-5	8	5/16	-5	7,9	9/16x18	56	32	17	19
16846-8-5	16848-8-5	8	5/16	-5	7,9	3/4x16	57	34	17	22
16846-4-6	16848-4-6	10	3/8	-6	9,5	7/16x20	50	27	14	17
16846-5-6	16848-5-6	10	3/8	-6	9,5	1/2x20	52	29	14	17
10646-6-6	10648-6-6	10	3/8	-6	9,5	9/16x18	52	30	17	19
16846-8-6	16848-8-6	10	3/8	-6	9,5	3/4x16	56	33	17	22
16846-10-6	16848-10-6	10	3/8	-6	9,5	7/8x14	59	36	22	27
10646-6-8	10648-6-8	12	1/2	-8	12,7	9/16x18	46	22	22	19
16846-8-8	16848-8-8	12	1/2	-8	12,7	3/4x16	56	32	22	22
16846-10-8	16848-10-8	12	1/2	-8	12,7	7/8x14	62	38	22	27
10646-12-8	10648-12-8	12	1/2	-8	12,7	1-1/16x12	62	38	27	32
16846-8-10	16848-8-10	16	5/8	-10	15,9	3/4x16	57	32	22	22
16846-10-10	16848-10-10	16	5/8	-10	15,9	7/8x14	60	35	22	27
10646-12-10	10648-12-10	16	5/8	-10	15,9	1-1/16x12	64	39	27	32
16846-8-12	16848-8-12	20	3/4	-12	19,1	3/4x16	58	32	24	22
16846-10-12	16848-10-12	20	3/4	-12	19,1	7/8x14	61	35	24	27
10646-12-12	10648-12-12	20	3/4	-12	19,1	1-1/16x12	67	41	27	32
10646-14-12	10648-14-12	20	3/4	-12	19,1	1-3/16x12	68	42	30	36
10646-16-12	10648-16-12	20	3/4	-12	19,1	1-5/16x12	71	45	32	41
10646-12-16	10648-12-16	25	1	-16	25,4	1-1/16x12	74	44	32	32
10646-16-16	10648-16-16	25	1	-16	25,4	1-5/16x12	76	46	32	41
10646-20-16	10648-20-16	25	1	-16	25,4	1-5/8x12	80	50	41	50
10646-16-20		32	1-1/4	-20	31,8	1-5/16x12	87	49	41	41
	10648-16-20	32	1-1/4	-20	31,8	1-5/16x12	97	50	46	41
10646-20-20		32	1-1/4	-20	31,8	1-5/8x12	89	51	46	50
	10648-20-20	32	1-1/4	-20	31,8	1-5/8x12	100	53	46	50
	10648-24-20°	32	1-1/4	-20	31,8	1-7/8x12	105	58	55	60
	10648-24-24	40	1-1/2	-24	38,1	1-7/8x12	98	60	55	60
	10648-32-32	50	2	-32	50,8	2-1/2x12	115	72	65	75

Information about standard products or non-standard products can be found in the current price list. Dimensions shown may be changed at any time without prior notice.

°Assembly only with Parkrimp 2 machine
Material: steel chromium(VI) free plated

08 – Female SAE 45° – Swivel – Straight

SAE J516

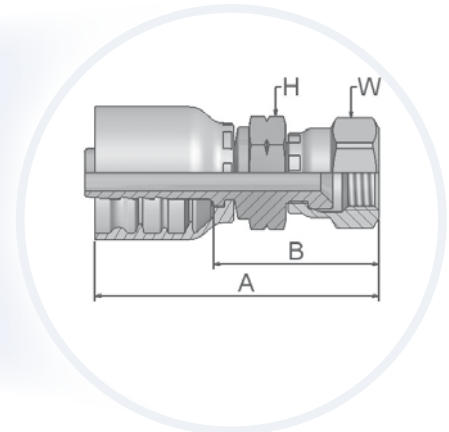
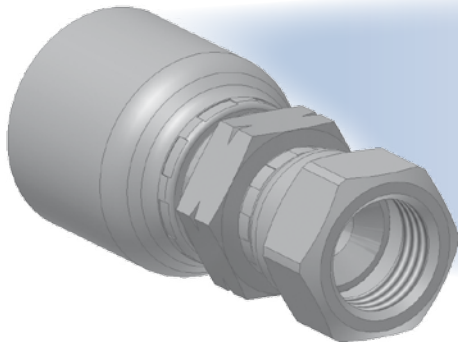

Approved fitting series for hose types:

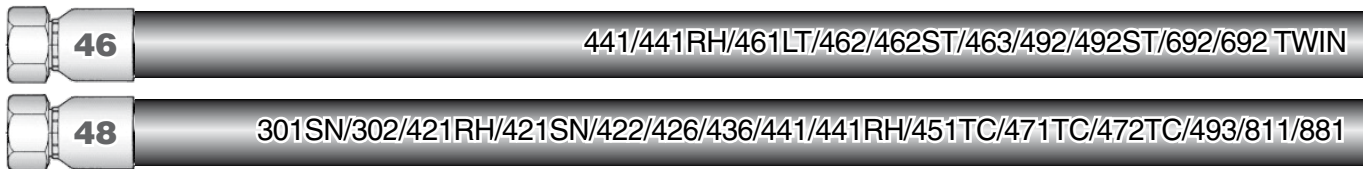

XXXX-XX-XX Part Number		Hose I.D.				Thread UNF	A mm	B mm	H mm	W mm
46	48	DN	Inch	Size	mm					
10846-6-4	10848-6-4	6	1/4	-4	6,3	5/8x18	58	34	14	19
10846-6-6	10848-6-6	10	3/8	-6	9,5	5/8x18	57	34	19	19

Material: steel chromium(VI) free plated

Information about standard products or non-standard products can be found in the current price list.
Dimensions shown may be changed at any time without prior notice.

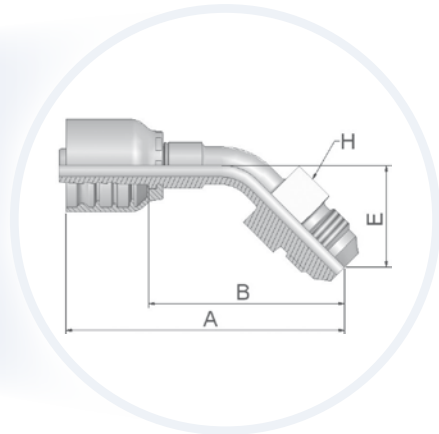
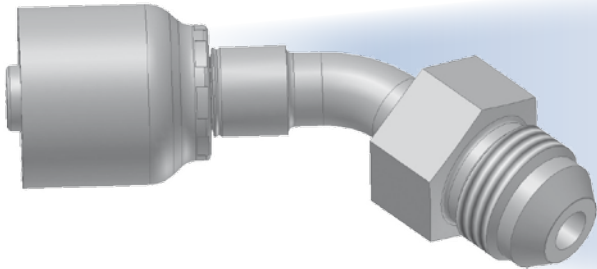

33 - Male JIC 37° - Rigid - 45° Elbow

ISO 12151-5 – AGJ 45°

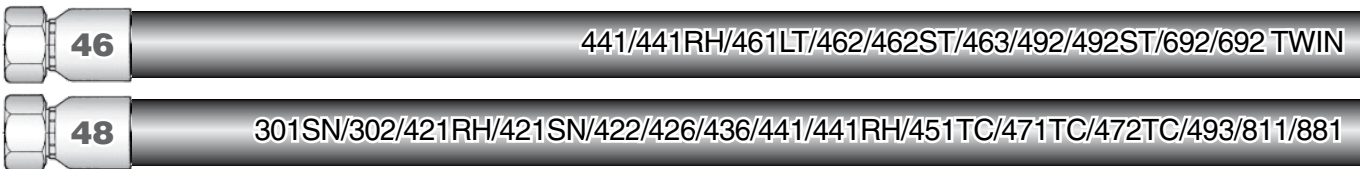

Approved fitting series for hose types:



XXXX-XX-XX Part Number		Hose I.D.				Thread NPTF	A	B	E	H
 46  48		DN	Inch	Size	mm		mm	mm	mm	mm
13346-8-6	13348-8-6	10	3/8	-6	9,5	3/4x16	77	54	28	22

Material: steel chromium(VI) free plated

Information about standard products or non-standard products can be found in the current price list. Dimensions shown may be changed at any time without prior notice.

37/3V – Female JIC 37° /SAE 45° – Dual Flare – Swivel Female 45° Elbow

ISO 12151-5-SWE45 – DKJ 45°

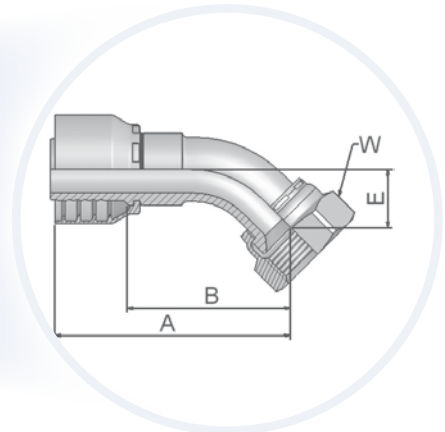
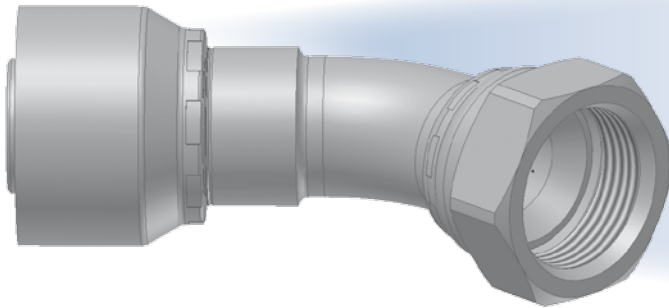

Approved fitting series for hose types:

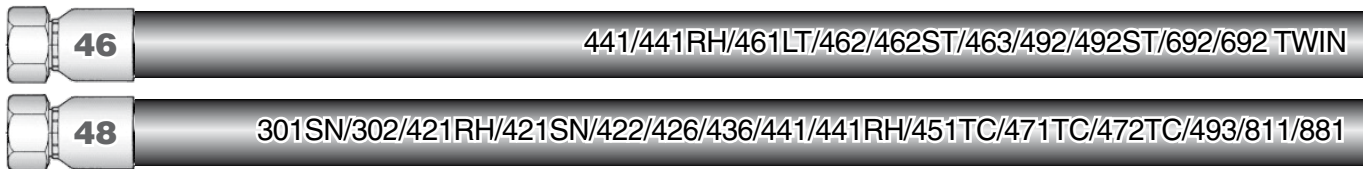

XXXX-XX-XX Part Number		Hose I.D.				Thread UNF	A	B	E	W
46	48	DN	Inch	Size	mm		mm	mm	mm	mm
13V46-4-4	13V48-4-4	6	1/4	-4	6,3	7/16x20	53	29	10	17
13V46-5-4	13V48-5-4	6	1/4	-4	6,3	1/2x20	57	33	9	17
13746-6-4	13748-6-4	6	1/4	-4	6,3	9/16x18	55	31	11	19
13V46-5-5	13V48-5-5	8	5/16	-5	7,9	1/2x20	53	29	10	17
13746-6-5	13748-6-5	8	5/16	-5	7,9	9/16x18	58	34	10	19
13746-6-6	13748-6-6	10	3/8	-6	9,5	9/16x18	60	37	11	19
13V46-8-6	13V48-8-6	10	3/8	-6	9,5	3/4x16	67	44	15	22
13V46-10-6	13V48-10-6	10	3/8	-6	9,5	7/8-14	69	46	17	27
13V46-8-8	13V48-8-8	12	1/2	-8	12,7	3/4x16	61	37	15	22
13V46-10-8	13V48-10-8	12	1/2	-8	12,7	7/8x14	70	46	16	27
13V46-10-10	13V48-10-10	16	5/8	-10	15,9	7/8x14	69	44	16	27
13746-12-10	13748-12-10	16	5/8	-10	15,9	1-1/16x12	74	49	21	32
13746-12-12	13748-12-12	20	3/4	-12	19,1	1-1/16x12	83	57	21	32
13746-14-12	13748-14-12	20	3/4	-12	19,1	1-3/16x12	84	58	22	36
13746-16-12	13748-16-12	20	3/4	-12	19,1	1-5/16x12	84	58	24	41
13746-12-16	13748-12-16	25	1	-16	25,4	1-1/16x12	91	61	21	32
13746-16-16	13748-16-16	25	1	-16	25,4	1-5/16x12	97	68	24	41
13746-20-16	13748-20-16	25	1	-16	25,4	1-5/8x12	101	71	26	50
13746-20-20		32	1-1/4	-20	31,8	1-5/8x12	129	91	31	50
	13748-20-20	32	1-1/4	-20	31,8	1-5/8x12	134	87	31	50
	13748-24-24	40	1-1/2	-24	38,1	1-7/8x12	165	127	58	60

Material: steel chromium(VI) free plated

Information about standard products or non-standard products can be found in the current price list. Dimensions shown may be changed at any time without prior notice.

39/3W – Female JIC 37° / SAE 45° – Dual Flare – Swivel Female 90° Elbow

ISO 12151-5-SWES – DKJ 90°

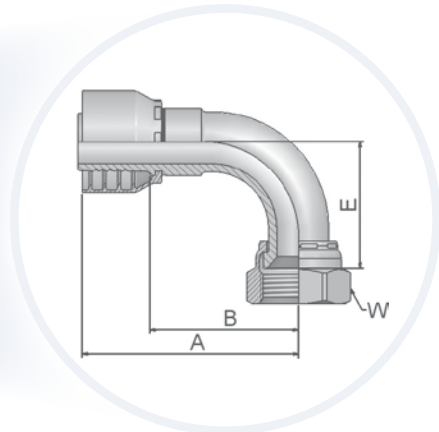
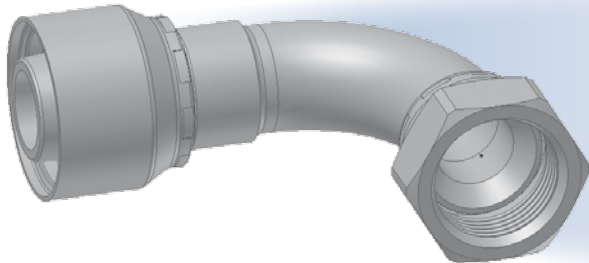

Approved fitting series for hose types:

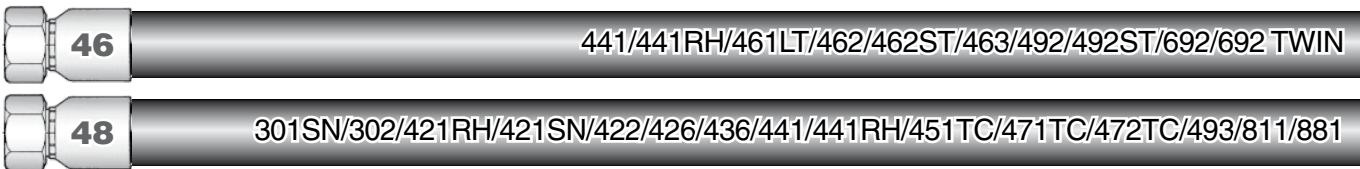

XXXX-XX-XX Part Number 46 48	Hose I.D.				Thread UNF	A mm	B mm	E mm	W mm	
	DN	Inch	Size	mm						
13W46-4-4	13W48-4-4	6	1/4	-4	6,3	7/16x20	48	24	21	17
13W46-5-4	13W48-5-4	6	1/4	-4	6,3	1/2x20	58	34	21	17
13946-6-4	13948-6-4	6	1/4	-4	6,3	9/16x18	51	27	23	19
13W46-5-5	13W48-5-5	8	5/16	-5	7,9	1/2x20	49	25	21	17
13946-6-5	13948-6-5	8	5/16	-5	7,9	9/16x18	51	28	23	19
13W46-4-6	13W48-4-6	10	3/8	-6	9,5	7/16x20	46	23	21	17
13946-6-6	13948-6-6	10	3/8	-6	9,5	9/16x18	51	28	23	19
13W46-8-6	13W48-8-6	10	3/8	-6	9,5	3/4x16	59	36	29	22
13W46-10-6	13W48-10-6	10	3/8	-6	9,5	7/8x14	61	38	32	27
13946-6-8	13948-6-8	12	1/2	-8	12,7	9/16x18	54	30	23	19
13W46-8-8	13W48-8-8	12	1/2	-8	12,7	3/4x16	55	31	29	22
13W46-10-8	13W48-10-8	12	1/2	-8	12,7	7/8x14	63	39	32	27
13946-12-8	13948-12-8	12	1/2	-8	12,7	1-1/16x12	73	49	48	32
13W46-10-10	13W48-10-10	16	5/8	-10	15,9	7/8x14	64	39	33	27
13946-12-10	13948-12-10	16	5/8	-10	15,9	1-1/16x12	75	49	48	32
13946-12-12	13948-12-12	20	3/4	-12	19,1	1-1/16x12	80	54	48	32
13946-14-12	13948-14-12	20	3/4	-12	19,1	1-3/16x12	80	54	51	36
13946-16-12	13948-16-12	20	3/4	-12	19,1	1-5/16x12	80	54	56	41
13946-12-16	13948-12-16	25	1	-16	25,4	1-1/16x12	88	58	48	32
13946-16-16	13948-16-16	25	1	-16	25,4	1-5/16x12	98	68	56	41
13946-20-16	13948-20-16	25	1	-16	25,4	1-5/8x12	98	68	62	50
13946-20-20		32	1-1/4	-20	31,8	1-5/8x12	124	86	70	50
	13948-20-20	32	1-1/4	-20	31,8	1-5/8x12	130	83	70	50
	13948-24-20°	32	1-1/4	-20	31,8	1-7/8x12	130	82	80	60
	13948-24-24	40	1-1/2	-24	38,1	1-7/8x12	140	102	84	60
	13948-32-32	50	2	-32	50,8	2-1/2x12	200	152	152	75

°Assembly only with Parkrimp 2 machine
Material: steel chromium(VI) free plated

Information about standard products or non-standard products can be found in the current price list.
Dimensions shown may be changed at any time without prior notice.

41/3Y – Female JIC 37° / 45° Swivel Female 90° Elbow (Long)

ISO 12151-5-SWEL – DKJ 90° L

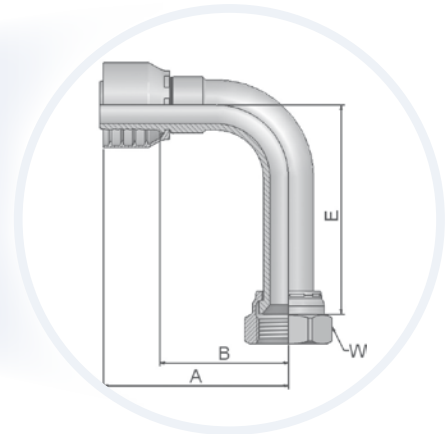
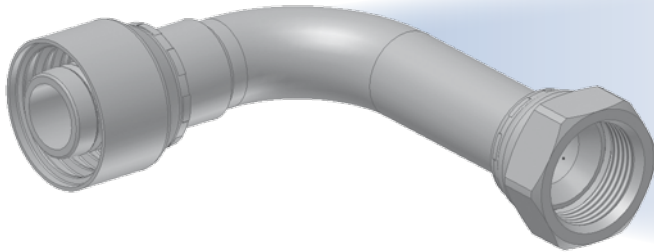

Approved fitting series for hose types:

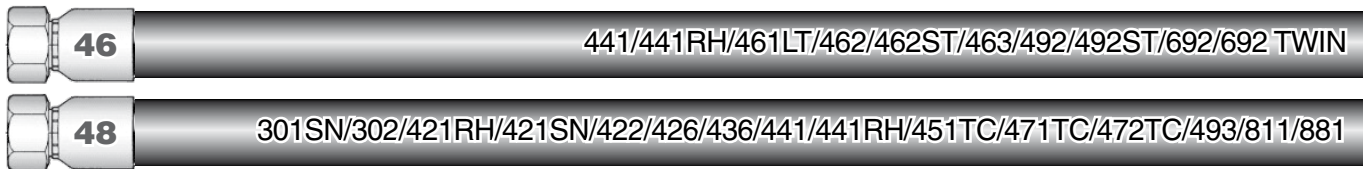

XXXX-XX-XX Part Number		Hose I.D.				Thread UNF	A	B	E	W
46	48	DN	Inch	Size	mm		mm	mm	mm	mm
13Y46-4-4	13Y48-4-4	6	1/4	-4	6,3	7/16x20	61	37	46	17
14146-6-4	14148-6-4	6	1/4	-4	6,3	9/16x18	57	34	55	19
14146-6-6	14148-6-6	10	3/8	-6	9,5	9/16x18	57	34	54	19
13Y46-8-6	13Y48-8-6	10	3/8	-6	9,5	3/4x16	55	32	62	22
13Y46-8-8	13Y48-8-8	12	1/2	-8	12,7	3/4x16	59	36	64	22
13Y46-10-8	13Y48-10-8	12	1/2	-8	12,7	7/8x14	68	44	66	27
13Y46-10-10	13Y48-10-10	16	5/8	-10	15,9	7/8x14	61	36	70	27
14146-12-12	14148-12-12	20	3/4	-12	19,1	1-1/16x12	80	54	96	32
14146-16-16	14148-16-16	25	1	-16	25,4	1-5/16x12	98	68	110	41

Material: steel chromium(VI) free plated

Information about standard products or non-standard products can be found in the current price list. Dimensions shown may be changed at any time without prior notice.

L9 – Female JIC 37° – Swivel – 90° Elbow – Medium Drop

ISO 12151-5-SWEM – DKJ 90° M

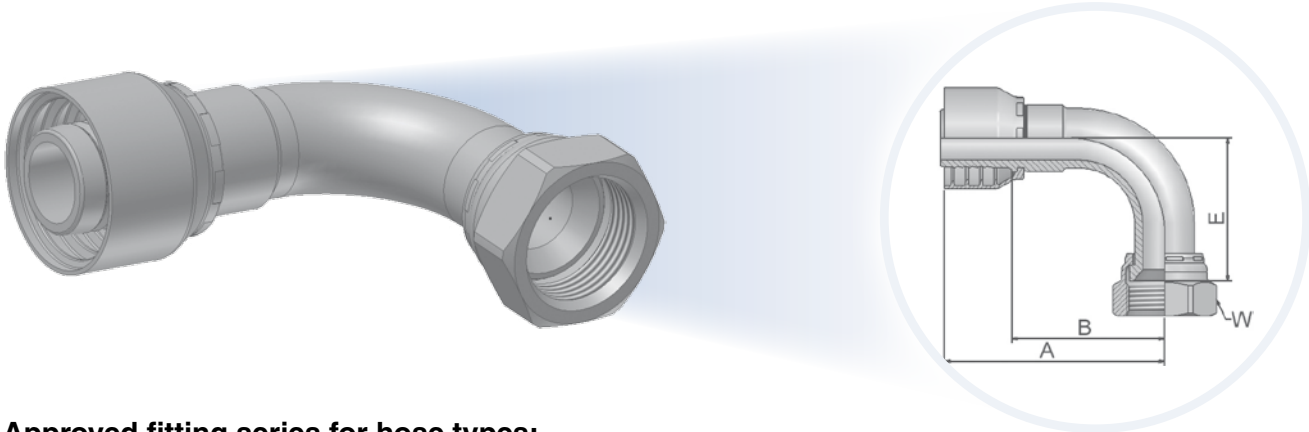

Approved fitting series for hose types:

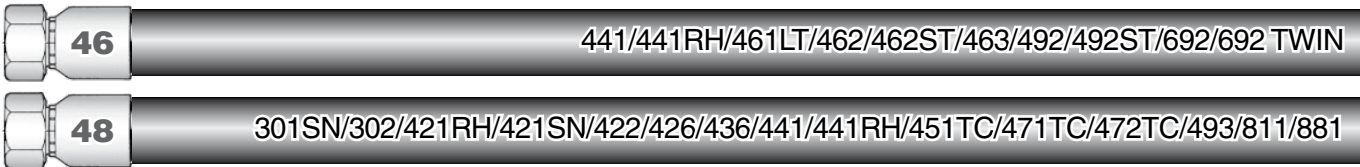

XXXX-XX-XX Part Number		Hose I.D.				Thread UNF	A	B	E	W
46	48	DN	Inch	Size	mm		mm	mm	mm	mm
1L946-8-6	1L948-8-6	10	3/8	-6	9,5	3/4x16	63	40	35	22
1L946-10-8	1L948-10-8	12	1/2	-8	12,7	7/8x14	66	42	45	27
1L946-12-12	1L948-12-12	20	3/4	-12	19,1	1-1/16x12	80	54	53	32
1L946-16-16	1L948-16-16	25	1	-16	25,4	1-5/16x12	97	68	64	41

Material: steel chromium(VI) free plated

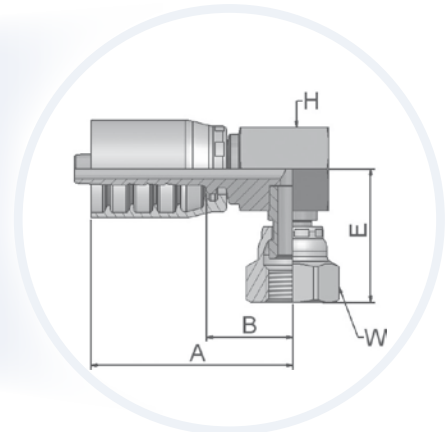
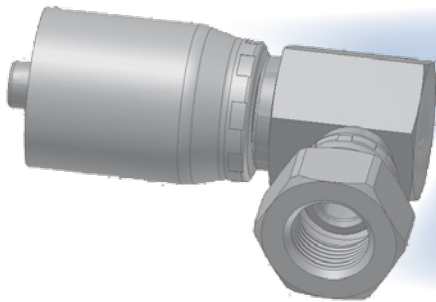

Information about standard products or non-standard products can be found in the current price list. Dimensions shown may be changed at any time without prior notice.

93 – Female JIC 37° – Swivel – 90° Elbow (Block Type)

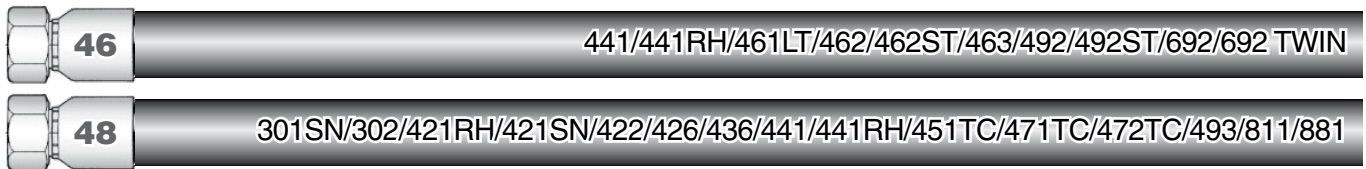

Approved fitting series for hose types:



XXXX-XX-XX Part Number	Hose I.D.				Thread UNF	A mm	B mm	E mm	H mm	W mm
	DN	Inch	Size	mm						
 46  48 19346-8-6 19348-8-6	10	3/8	-6	9,5	3/4x16	43	20	20	19	22

Material: steel chromium(VI) free plated

Information about standard products or non-standard products can be found in the current price list.
Dimensions shown may be changed at any time without prior notice.

15 – SAE Code 61 – Flange Head – Straight

ISO 12151-3-S-L – SFL – 3000 psi

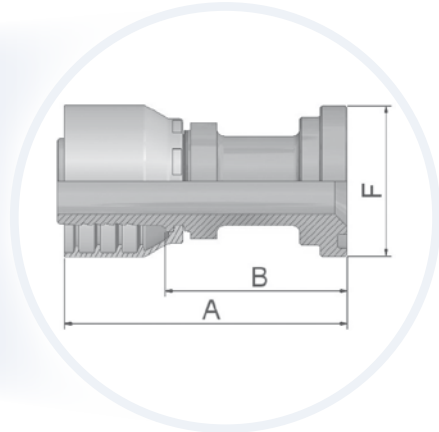
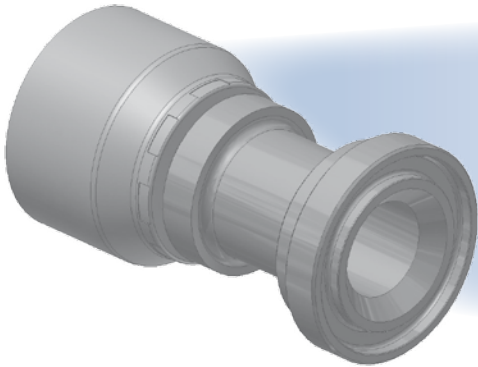

Approved fitting series for hose types:

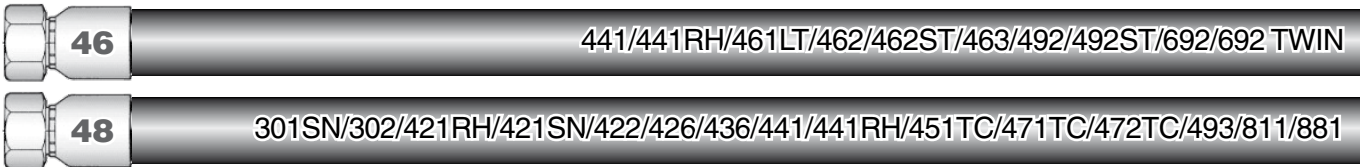

XXXX-XX-XX Part Number		Hose I.D.				End Connection	A	B	F
46	48	DN	Inch	Size	mm		mm	mm	mm
11546-8-8	11548-8-8	12	1/2	-8	12,7	1/2	74	51	30
11546-12-8	11548-12-8	12	1/2	-8	12,7	3/4	51	27	38
11546-12-10	11548-12-10	16	5/8	-10	15,9	3/4	56	31	38
11546-12-12	11548-12-12	20	3/4	-12	19,1	3/4	82	56	38
11546-16-12	11548-16-12	20	3/4	-12	19,1	1	56	30	45
11546-20-12	11548-20-12	20	3/4	-12	19,1	1-1/4	77	51	51
11546-16-16	11548-16-16	25	1	-16	25,4	1	84	54	45
11546-20-16	11548-20-16	25	1	-16	25,4	1-1/4	104	74	51
11546-24-16	11548-24-16	25	1	-16	25,4	1-1/2	97	67	60
	11548-16-20	32	1-1/4	-20	31,8	1	120	72	45
11546-20-20		32	1-1/4	-20	31,8	1-1/4	114	76	51
	11548-20-20	32	1-1/4	-20	31,8	1-1/4	120	72	51
11546-24-20°		32	1-1/4	-20	31,8	1-1/2	72	35	60
	11548-24-20°	32	1-1/4	-20	31,8	1-1/2	82	35	60
	11548-32-20°	32	1-1/4	-20	31,8	2	123	76	71
	11548-16-24	40	1-1/2	-24	38,1	1	109	71	45
	11548-24-24	40	1-1/2	-24	38,1	1-1/2	117	79	60
	11548-32-24	40	1-1/2	-24	38,1	2	80	42	71
	11548-24-32	50	2	-32	50,8	1-1/2	129	81	60
	11548-32-32	50	2	-32	50,8	2	126	78	71

°Assembly only with Parkrimp 2 machine
To select corresponding half-flange and O-ring see Section Eb.
Material: steel chromium(VI) free plated

Information about standard products or non-standard products can be found in the current price list.
Dimensions shown may be changed at any time without prior notice.

17 – SAE Code 61 – Flange Head – 45° Elbow

ISO 12151-3-E45-L – SFL 45° – 3000 psi

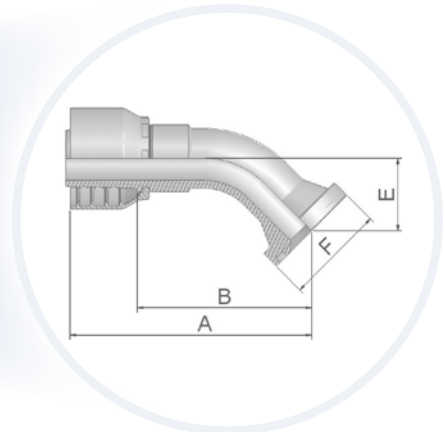
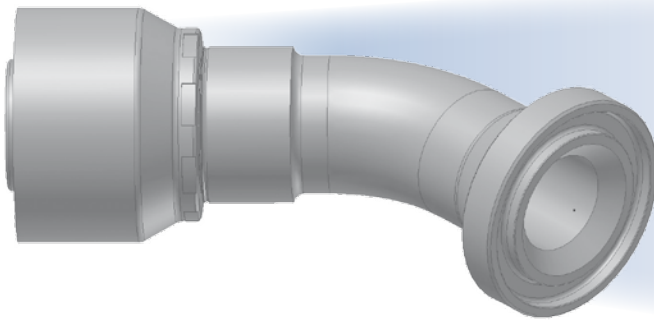

Approved fitting series for hose types:

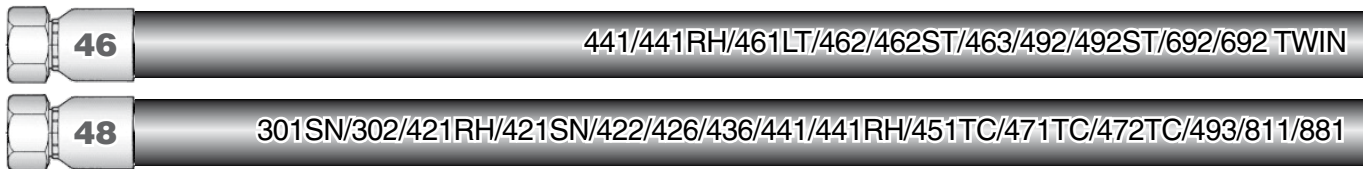

XXXX-XX-XX Part Number		Hose I.D.				End Connection	A	B	E	F
46	48	DN	Inch	Size	mm		mm	mm	mm	
11746-8-8	11748-8-8	12	1/2	-8	12,7	1/2	72	48	20	30
11746-12-8	11748-12-8	12	1/2	-8	12,7	3/4	71	47	21	38
11746-12-10	11748-12-10	16	5/8	-10	15,9	3/4	75	50	24	38
11746-12-12	11748-12-12	20	3/4	-12	19,1	3/4	88	62	25	38
11746-16-12	11748-16-12	20	3/4	-12	19,1	1	87	61	25	45
11746-20-12	11748-20-12	20	3/4	-12	19,1	1-1/4	87	61	25	51
11746-16-16	11748-16-16	25	1	-16	25,4	1	107	78	32	45
11746-20-16	11748-20-16	25	1	-16	25,4	1-1/4	104	74	27	51
	11748-16-20	32	1-1/4	-20	31,8	1	132	85	29	45
11746-20-20		32	1-1/4	-20	31,8	1-1/4	136	98	38	51
	11748-20-20	32	1-1/4	-20	31,8	1-1/4	132	85	29	51
11746-24-20°		32	1-1/4	-20	31,8	1-1/2	136	98	38	60
	11748-24-20°	32	1-1/4	-20	31,8	1-1/2	141	94	38	60
	11748-24-24	40	1-1/2	-24	38,1	1-1/2	143	106	37	60
	11748-32-24	40	1-1/2	-24	38,1	2	143	105	36	71
	11748-24-32	50	2	-32	50,8	1-1/2	153	105	36	60
	11748-32-32	50	2	-32	50,8	2	181	133	50	71

°Assembly only with Parkrimp 2 machine
To select corresponding half-flange and O-ring see Section Eb.
Material: steel chromium(VI) free plated

Information about standard products or non-standard products can be found in the current price list.
Dimensions shown may be changed at any time without prior notice.

19 – SAE Code 61 – Flange Head – 90° Elbow

ISO 12151-3-E-L – SFL 90° – 3000 psi

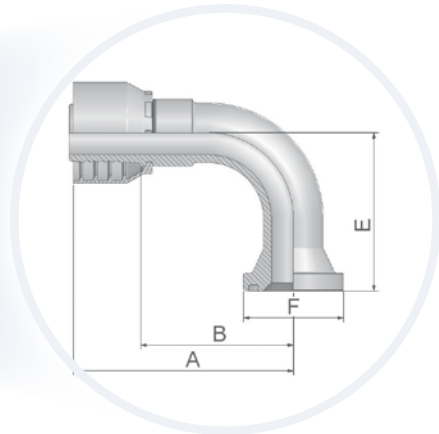
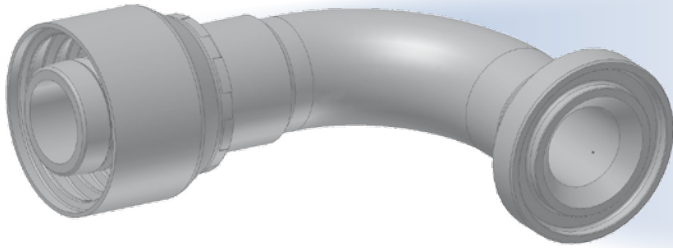

Approved fitting series for hose types:

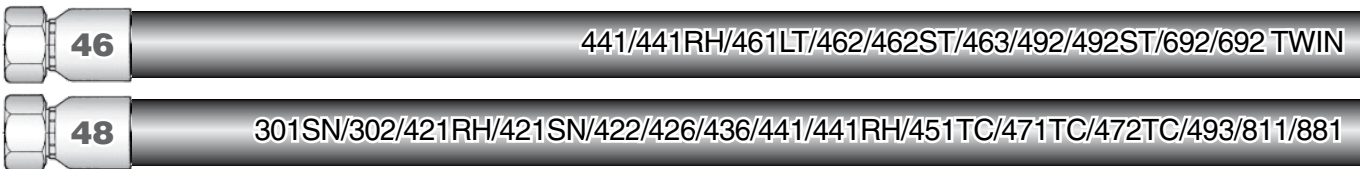

XXXX·XX·XX Part Number	Hose I.D.	End Connection	A	B	E	F
11946-8-8	11948-8-8	1/2	64	40	41	30
11946-12-8	11948-12-8	3/4	71	47	43	38
11946-12-10	11948-12-10	3/4	78	53	52	38
11946-16-10	11948-16-10	1	78	53	52	45
11946-12-12	11948-12-12	3/4	80	54	58	38
11946-16-12	11948-16-12	1	80	54	58	45
11946-20-12	11948-20-12	1-1/4	81	55	54	51
	11948-12-16	3/4	98	68	70	38
11946-16-16	11948-16-16	1	98	68	70	45
11946-20-16	11948-20-16	1-1/4	103	73	60	51
11946-24-16	11948-24-16	1-1/2	100	70	62	60
11946-12-20		3/4	125	87	70	38
11946-20-20		1-1/4	124	86	90	51
	11948-20-20	1-1/4	130	82	90	51
11946-24-20°		1-1/2	124	86	90	60
	11948-24-20°	1-1/2	130	83	67	60
	11948-32-20°	2	130	83	67	71
	11948-24-24	1-1/2	140	102	79	60
	11948-32-24	2	139	101	104	71
	11948-24-32	1-1/2	154	106	104	60
	11948-32-32	2	187	138	114	71

°Assembly only with Parkrimp 2 machine
To select corresponding half-flange and O-ring see Section Eb.
Material: steel chromium(VI) free plated

Information about standard products or non-standard products can be found in the current price list.
Dimensions shown may be changed at any time without prior notice.

6A – SAE Code 62 – Flange – Straight

ISO 12151-3-S-S – SFS – 6000 psi

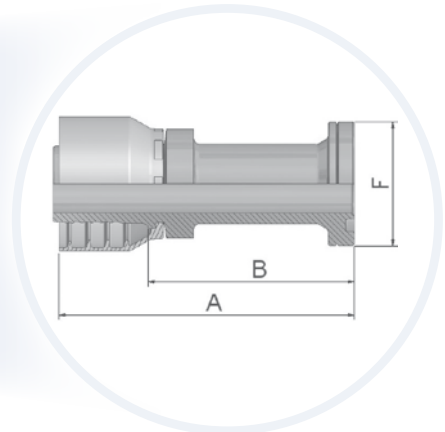
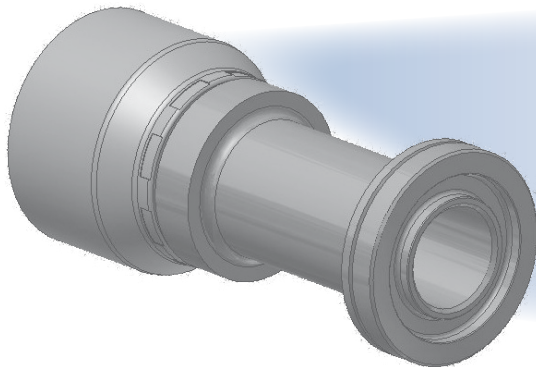

Approved fitting series for hose types:

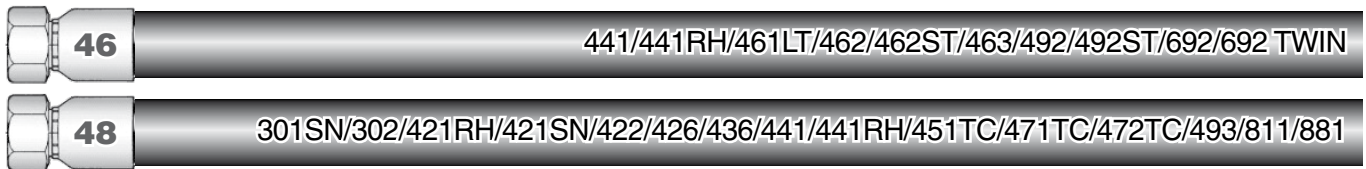

XXXX-XX-XX Part Number		Hose I.D.				End Connection	A	B	F
46	48	DN	Inch	Size	mm		mm	mm	mm
16A46-8-8	16A48-8-8	12	1/2	-8	12,7	1/2	75	52	32
16A46-12-12	16A48-12-12	20	3/4	-12	19,1	3/4	96	70	41
16A46-16-16	16A48-16-16	25	1	-16	25,4	1	111	82	48
16A46-20-20	16A48-20-20	32	1-1/4	-20	31,8	1-1/4	122	84	54
	16A48-24-20°	32	1.1/4	-20	31,8	1-1/2	131	84	64
	16A48-24-24	40	1-1/2	-24	38,1	1-1/2	141	103	64
	16A48-32-32	50	2	-32	50,8	2	173	124	79

°Assembly only with Parkrimp 2 machine
To select corresponding half-flange and O-ring see Section Eb.
Material: steel chromium(VI) free plated

Information about standard products or non-standard products can be found in the current price list.
Dimensions shown may be changed at any time without prior notice.

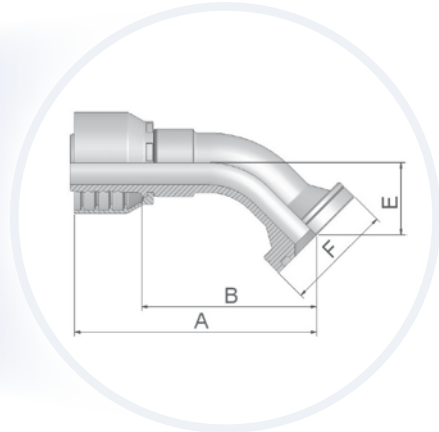
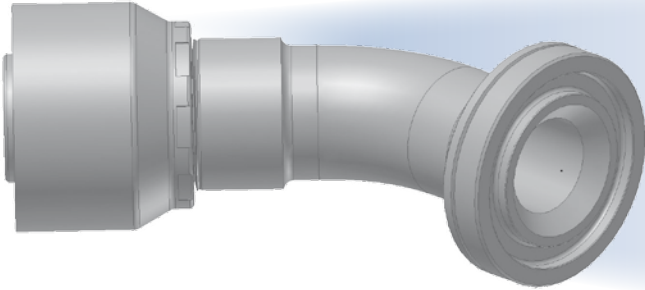

6F – SAE Flange 45° Elbow – Heavy Series

ISO 12151-3-E45-S – SFS 45° – 6000 psi

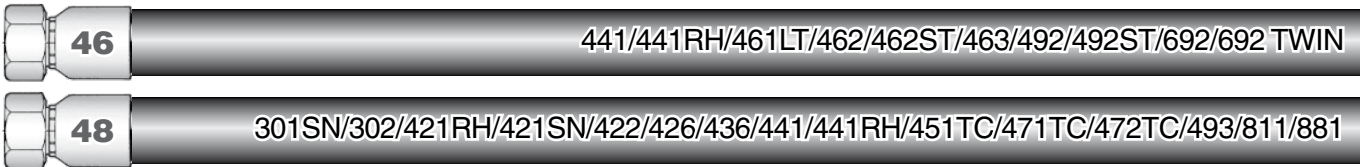

Approved fitting series for hose types:



XXXX-XX-XX Part Number		Hose I.D.				End Connection	A	B	E	F
 		DN	Inch	Size	mm		mm	mm	mm	mm
16F46-12-12	16F48-12-12	20	3/4	-12	19,1	3/4	88	62	26	41
16F46-16-16	16F48-16-16	25	1	-16	25,4	1	107	78	32	48
16F46-20-20	16F48-20-20	32	1-1/4	-20	31,8	1-1/4	141	94	38	54
	16F48-24-24	40	1.1/2	-24	38,1	1-1/2	150	112	44	64
	16F48-32-32	50	2	-32	50,8	2	183	135	52	79

To select corresponding half-flange and O-ring see Section Eb.
Material: steel chromium(VI) free plated

Information about standard products or non-standard products can be found in the current price list.
Dimensions shown may be changed at any time without prior notice.

6N – SAE Code 62 Flange Head – 90° Elbow

ISO 12151-3 -E-S – SFS 90° – 6000 psi

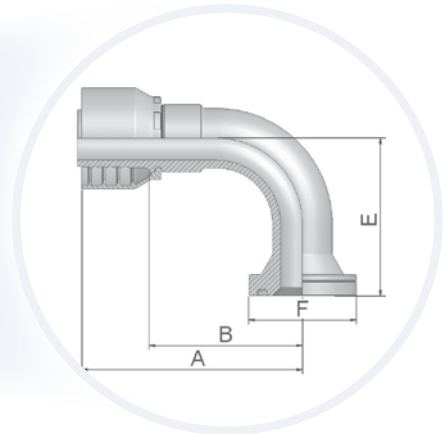
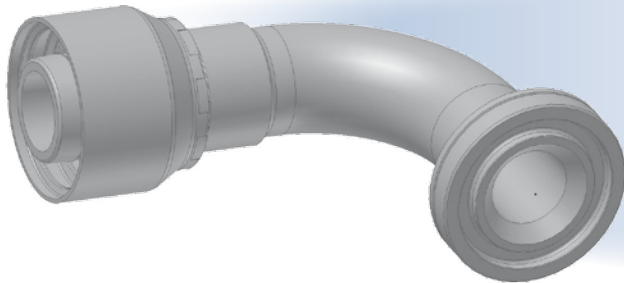

Approved fitting series for hose types:

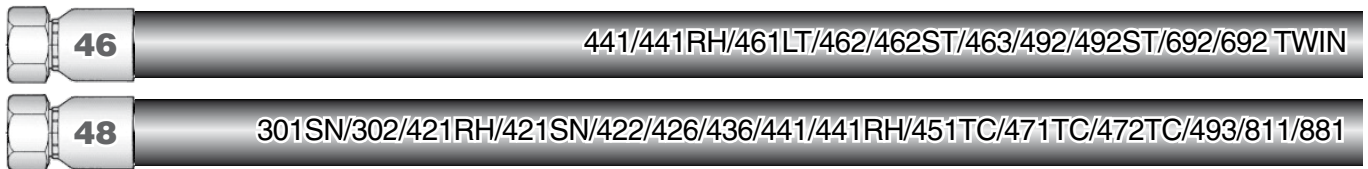

XXXX-XX-XX Part Number	Hose I.D.				End Connection	A	B	E	F
	DN	Inch	Size	mm					
16N48-8-12	20	3/4	-12	19,1	1/2	70	44	40	32
16N46-12-12	20	3/4	-12	19,1	3/4	80	54	54	41
16N46-16-12	20	3/4	-12	19,1	1	80	54	53	48
16N46-12-16	25	1	-16	25,4	3/4	88	58	58	41
16N46-16-16	25	1	-16	25,4	1	98	68	70	48
16N46-20-20	32	1-1/4	-20	31,8	1-1/4	124	86	70	54
16N48-20-20	32	1-1/4	-20	31,8	1-1/4	130	82	70	54
16N48-24-24	40	1.1/2	-24	38,1	1-1/2	139	101	104	64
16N48-32-32	50	2	-32	50,8	2	172	124	115	79

To select corresponding half-flange and O-ring see Section Eb.
Material: steel chromium(VI) free plated

Information about standard products or non-standard products can be found in the current price list.
Dimensions shown may be changed at any time without prior notice.

JC – Female ORFS – Swivel – Straight – Short

ISO 12151-1-SWSA – SAE J516 – ORFS

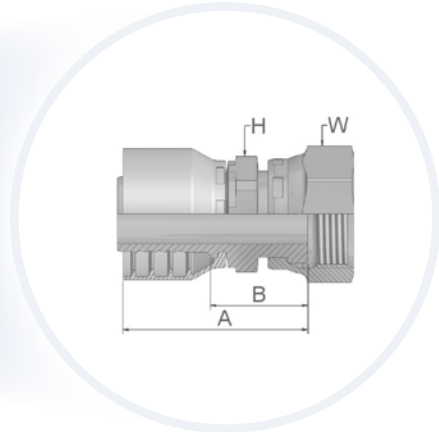
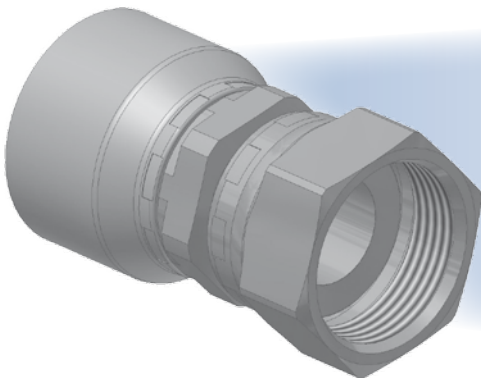

Approved fitting series for hose types:

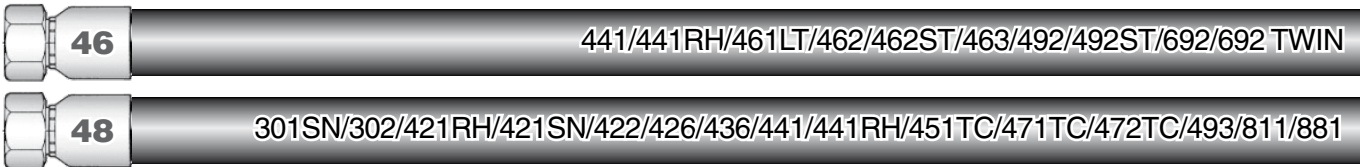

XXXX-XX-XX Part Number		Hose I.D.				Thread UNF	A mm	B mm	H mm	W mm
46	48	DN	Inch	Size	mm					
1JC46-4-4	1JC48-4-4	6	1/4	-4	6,3	9/16x18	46	22	14	17
1JC46-6-4	1JC48-6-4	6	1/4	-4	6,3	11/16x16	45	23	17	22
1JC46-8-4	1JC48-8-4	6	1/4	-4	6,3	13/16x16	46	22	19	24
1JC46-6-5	1JC48-6-5	8	5/16	-5	7,9	11/16x16	47	23	17	22
1JC46-4-6	1JC48-4-6	10	3/8	-6	9,5	9/16x18	42	19	17	17
1JC46-6-6	1JC48-6-6	10	3/8	-6	9,5	11/16x16	43	21	17	22
1JC46-8-6	1JC48-8-6	10	3/8	-6	9,5	13/16x16	45	22	19	24
1JC46-6-8	1JC48-6-8	12	1/2	-8	12,7	11/16x16	44	20	17	22
1JC46-8-8	1JC48-8-8	12	1/2	-8	12,7	13/16x16	46	22	22	24
1JC46-10-8	1JC48-10-8	12	1/2	-8	12,7	1x14	48	24	24	30
1JC46-12-8	1JC48-12-8	12	1/2	-8	12,7	1-3/16x12	53	29	30	36
1JC46-8-10	1JC48-8-10	16	5/8	-10	15,9	13/16x16	47	22	22	24
1JC46-10-10	1JC48-10-10	16	5/8	-10	15,9	1x14	51	26	24	30
1JC46-12-10	1JC48-12-10	16	5/8	-10	15,9	1-3/16x12	54	28	30	36
1JC46-10-12	1JC48-10-12	20	3/4	-12	19,1	1x14	54	28	24	30
1JC46-12-12	1JC48-12-12	20	3/4	-12	19,1	1-3/16x12	55	29	30	36
1JC46-16-12	1JC48-16-12	20	3/4	-12	19,1	1-7/16x12	59	33	36	41
	1JC48-12-16	25	1	-16	25,4	1-3/16x12	60	30	32	36
1JC46-16-16	1JC48-16-16	25	1	-16	25,4	1-7/16x12	63	33	36	41
1JC46-20-16	1JC48-20-16	25	1	-16	25,4	1-11/16x12	62	32	41	50
1JC46-20-20		32	1-1/4	-20	31,8	1-11/16x12	71	33	41	50
	1JC48-20-20	32	1-1/4	-20	31,8	1-11/16x12	85	36	41	50

Material: steel chromium(VI) free plated

Information about standard products or non-standard products can be found in the current price list. Dimensions shown may be changed at any time without prior notice.

JS – ORFS Swivel Female (Long)

ISO 12151-1-SWSB – SAE J516 – ORFS

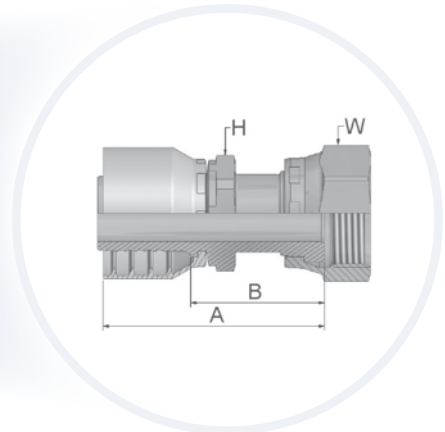
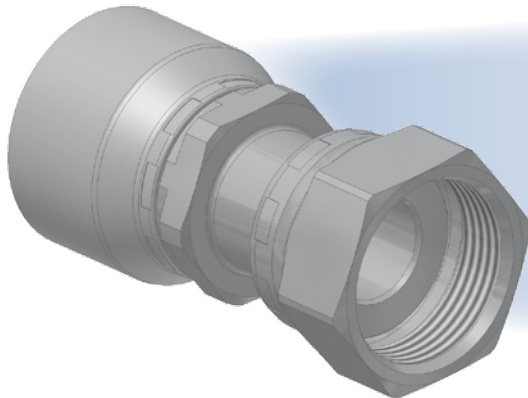

Approved fitting series for hose types:

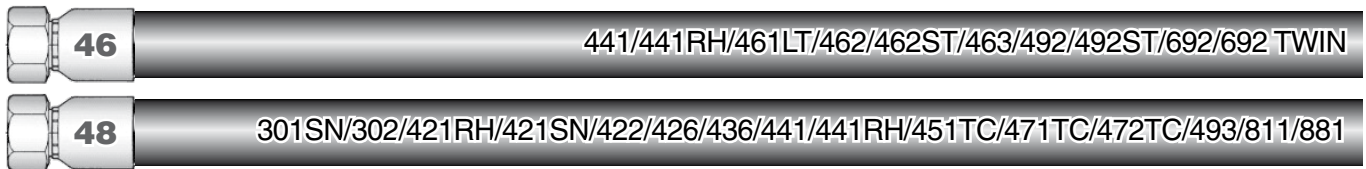

XXXX-XX-XX Part Number		Hose I.D.				Thread UNF	A	B	H	W
46	48	DN	Inch	Size	mm		mm	mm	mm	mm
1JS46-4-4	1JS48-4-4	6	1/4	-4	6,3	9/16x18	53	29	14	17
1JS46-6-4	1JS48-6-4	6	1/4	-4	6,3	11/16x16	54	31	17	22
1JS46-6-5	1JS48-6-5	8	5/16	-5	7,9	11/16x16	55	31	17	22
1JS46-4-6	1JS48-4-6	10	3/8	-6	9,5	9/16x18	53	30	14	17
1JS46-6-6	1JS48-6-6	10	3/8	-6	9,5	11/16x16	52	29	17	22
1JS46-8-6	1JS48-8-6	10	3/8	-6	9,5	13/16x16	58	35	19	24
1JS46-6-8	1JS48-6-8	12	1/2	-8	12,7	11/16x16	52	29	17	22
1JS46-8-8	1JS48-8-8	12	1/2	-8	12,7	13/16x16	57	33	22	24
1JS46-10-8	1JS48-10-8	12	1/2	-8	12,7	1x14	63	39	24	30
1JS46-10-10	1JS48-10-10	16	5/8	-10	15,9	1x14	65	39	24	30
1JS46-12-10	1JS48-12-10	16	5/8	-10	15,9	1-3/16x12	70	45	30	36
1JS46-10-12	1JS48-10-12	20	3/4	-12	19,1	1x14	66	40	24	30
1JS46-12-12	1JS48-12-12	20	3/4	-12	19,1	1-3/16x12	71	45	30	36
1JS46-16-12	1JS48-16-12	20	3/4	-12	19,1	1-7/16x12	73	47	36	41
1JS46-16-16	1JS48-16-16	25	1	-16	25,4	1-7/16x12	76	46	36	41
1JS46-20-16	1JS48-20-16	25	1	-16	25,4	1-11/16x12	78	48	41	50
1JS46-20-20		32	1-1/4	-20	31,8	1-11/16x12	88	50	41	50
	1JS48-20-20	32	1-1/4	-20	31,8	1-11/16x12	102	54	46	50
	1JS48-24-24	40	1-1/2	-24	38,1	2x12	100	62	50	60

Material: steel chromium(VI) free plated

Information about standard products or non-standard products can be found in the current price list. Dimensions shown may be changed at any time without prior notice.

J7 - Female ORFS – Swivel – 45° Elbow

ISO 12151-1-SWE45 – SAE J516 – ORFS 45°

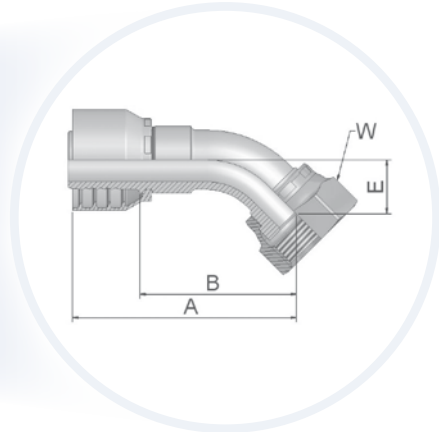
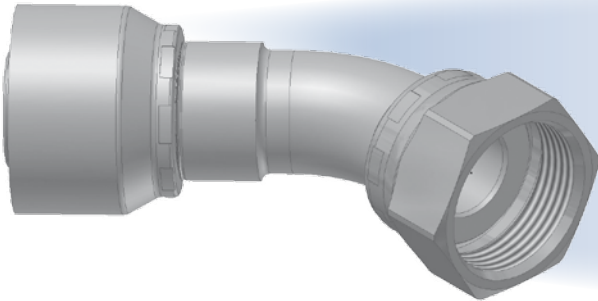

Approved fitting series for hose types:

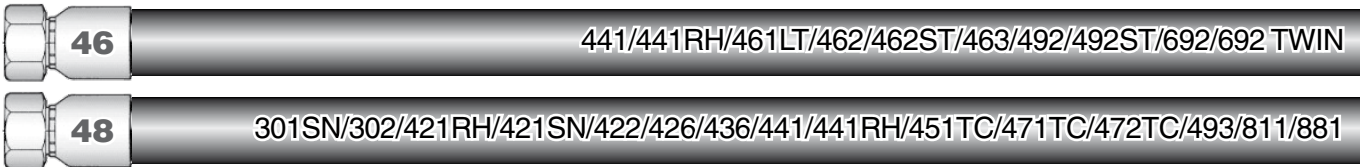

XXXX-XX-XX Part Number		Hose I.D.				Thread UNF	A mm	B mm	E mm	W mm
46	48	DN	Inch	Size	mm					
1J746-4-4	1J748-4-4	6	1/4	-4	6,3	9/16x18	52	28	10	17
1J746-6-4	1J748-6-4	6	1/4	-4	6,3	11/16x16	53	30	11	22
1J746-6-5	1J748-6-5	8	5/16	-5	7,9	11/16x16	56	32	11	22
1J746-6-6	1J748-6-6	10	3/8	-6	9,5	11/16x16	54	31	11	22
1J746-8-6	1J748-8-6	10	3/8	-6	9,5	13/16x16	59	36	15	24
1J746-6-8	1J748-6-8	12	1/2	-8	12,7	11/16x16	57	33	11	22
1J746-8-8	1J748-8-8	12	1/2	-8	12,7	13/16x16	61	38	15	24
1J746-10-8	1J748-10-8	12	1/2	-8	12,7	1x14	65	42	16	30
1J746-12-8	1J748-12-8	12	1/2	-8	12,7	1-3/16x12	77	53	21	36
1J746-10-10	1J748-10-10	16	5/8	-10	15,9	1x14	67	42	16	30
1J746-12-10	1J748-12-10	16	5/8	-10	15,9	1-3/16x12	81	55	21	36
1J746-10-12	1J748-10-12	20	3/4	-12	19,1	1x14	73	47	16	30
1J746-12-12	1J748-12-12	20	3/4	-12	19,1	1-3/16x12	83	57	21	36
1J746-16-12	1J748-16-12	20	3/4	-12	19,1	1-7/16x12	94	68	24	41
1J746-12-16	1J748-12-16	25	1	-16	25,4	1-3/16x12	91	61	21	36
1J746-16-16	1J748-16-16	25	1	-16	25,4	1-7/16x12	100	70	24	41
1J746-20-16	1J748-20-16	25	1	-16	25,4	1-11/16x12	101	71	26	50
1J746-20-20		32	1-1/4	-20	31,8	1-11/16x12	124	86	26	50
	1J748-20-20	32	1-1/4	-20	31,8	1-11/16x12	130	82	27	50
	1J748-24-24	40	1.1/2	-24	38,1	2x12	148	110	40	60

Material: steel chromium(VI) free plated

Information about standard products or non-standard products can be found in the current price list. Dimensions shown may be changed at any time without prior notice.

J9 – Female ORFS – Swivel – 90° Elbow – Short Drop

ISO 12151-1-SWES – SAE J516 – ORFS 90°

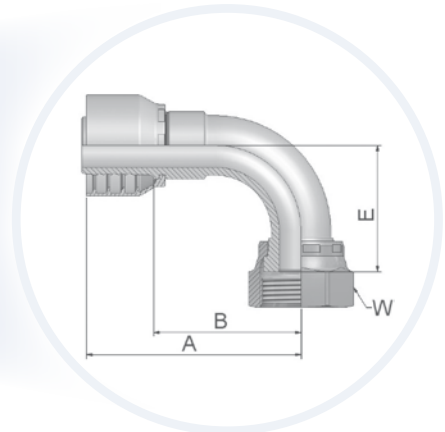
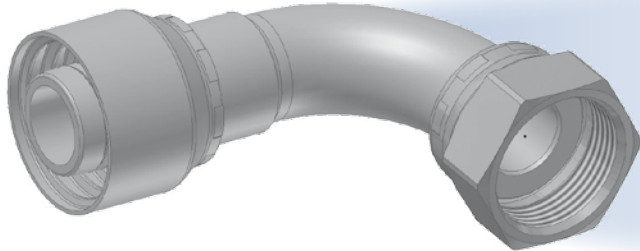

Approved fitting series for hose types:

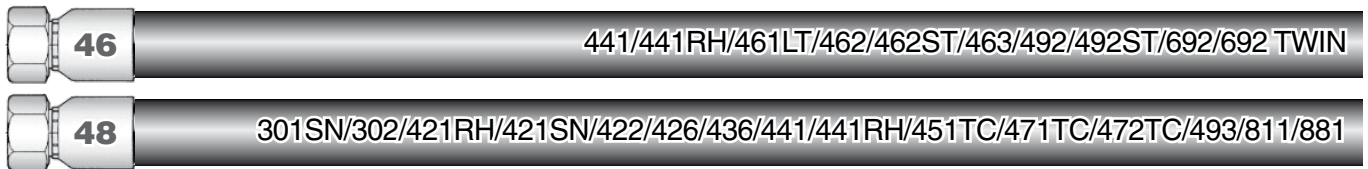

XXXX-XX-XX Part Number		Hose I.D.				Thread UNF	A mm	B mm	E mm	W mm
46	48	DN	Inch	Size	mm					
1J946-4-4	1J948-4-4	6	1/4	-4	6,3	9/16x18	48	24	21	17
1J946-6-4	1J948-6-4	6	1/4	-4	6,3	11/16x16	48	24	23	22
1J946-8-4	1J948-8-4	6	1/4	-4	6,3	13/16x16	50	26	29	24
1J946-6-5	1J948-6-5	8	5/16	-5	7,9	11/16x16	53	29	23	22
1J946-4-6	1J948-4-6	10	3/8	-6	9,5	9/16x18	47	24	21	17
1J946-6-6	1J948-6-6	10	3/8	-6	9,5	11/16x16	52	29	23	22
1J946-8-6	1J948-8-6	10	3/8	-6	9,5	13/16x16	53	30	29	24
1J946-6-8	1J948-6-8	12	1/2	-8	12,7	11/16x16	53	29	23	22
1J946-8-8	1J948-8-8	12	1/2	-8	12,7	13/16x16	55	32	29	24
1J946-10-8	1J948-10-8	12	1/2	-8	12,7	1x14	66	43	32	30
1J946-12-8	1J948-12-8	12	1/2	-8	12,7	1-3/16x12	58	34	48	36
1J946-10-10	1J948-10-10	16	5/8	-10	15,9	1x14	66	40	32	30
1J946-12-10	1J948-12-10	16	5/8	-10	15,9	1-3/16x12	71	45	48	36
1J946-10-12	1J948-10-12	20	3/4	-12	19,1	1x14	69	43	32	30
1J946-12-12	1J948-12-12	20	3/4	-12	19,1	1-3/16x12	80	54	48	36
1J946-16-12	1J946-16-12	20	3/4	-12	19,1	1-7/16x12	88	62	56	41
1J946-12-16	1J948-12-16	25	1	-16	25,4	1-3/16-12	88	58	48	36
1J946-16-16	1J948-16-16	25	1	-16	25,4	1-7/16x12	96	66	56	41
1J946-20-16	1J948-20-16	25	1	-16	25,4	1-11/16x12	104	74	64	50
1J946-20-20		32	1-1/4	-20	31,8	1-11/16x12	124	86	64	50
	1J948-20-20	32	1-1/4	-20	31,8	1-11/16x12	130	83	64	50
	1J948-24-24	40	1-1/2	-24	38,1	2x12	140	102	82	60

Material: steel chromium(VI) free plated

Information about standard products or non-standard products can be found in the current price list. Dimensions shown may be changed at any time without prior notice.

J1 – Female ORFS – Swivel – 90° Elbow – Long Drop

ISO 12151-1-SWEL – SAE J 516 – ORFS 90° L

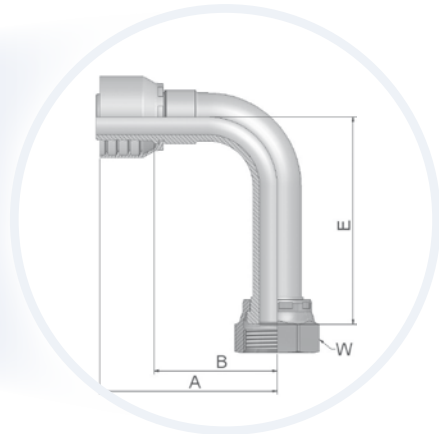
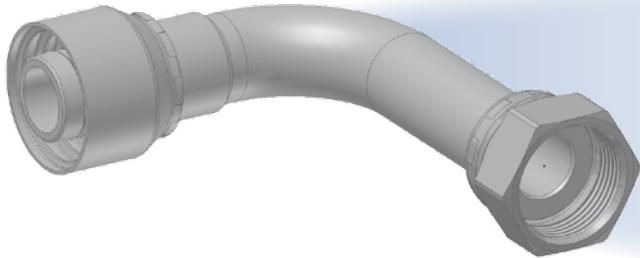

Approved fitting series for hose types:

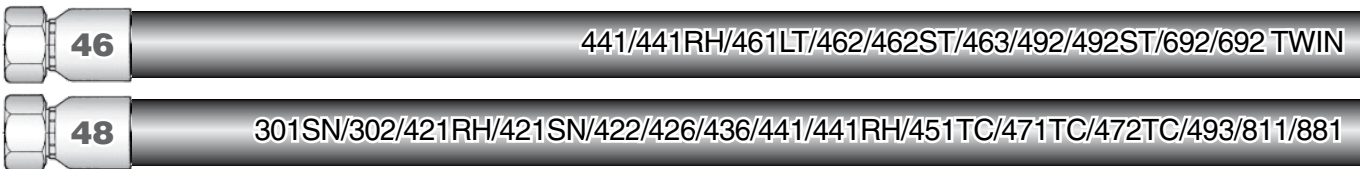

XXXX-XX-XX Part Number		Hose I.D.				Thread UNF	A mm	B mm	E mm	W mm
46	48	DN	Inch	Size	mm					
1J146-4-4	1J148-4-4	6	1/4	-4	6,3	9/16x18	58	35	46	17
1J146-6-4	1J148-6-4	6	1/4	-4	6,3	11/16x16	60	36	54	22
1J146-6-6	1J148-6-6	10	3/8	-6	9,5	11/16x16	58	35	54	22
1J146-8-6	1J148-8-6	10	3/8	-6	9,5	13/16x16	60	37	64	24
1J146-8-8	1J148-8-8	12	1/2	-8	12,7	13/16x16	61	37	64	24
1J146-10-8	1J148-10-8	12	1/2	-8	12,7	1x14	66	43	70	30
1J146-10-10	1J148-10-10	16	5/8	-10	15,9	1x14	65	40	70	30
1J146-12-10	1J148-12-10	16	5/8	-10	15,9	1-3/16x12	70	45	96	36
1J146-12-12	1J148-12-12	20	3/4	-12	19,1	1-3/16x12	80	54	96	36
1J146-16-16	1J148-16-16	25	1	-16	25,4	1-7/16x12	95	66	114	41
	1J148-20-20	32	1-1/4	-20	31,8	1-11/16x12	130	82	129	50

Material: steel chromium(VI) free plated

Information about standard products or non-standard products can be found in the current price list. Dimensions shown may be changed at any time without prior notice.

J5 – Female ORFS – Swivel – 90° Elbow – Medium Drop

ISO 12151-1-SWEM – SAE J 516 – ORFS 90° M

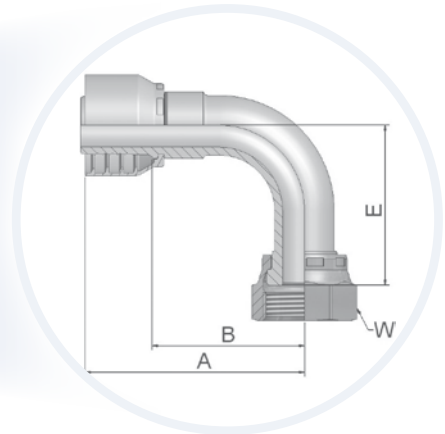
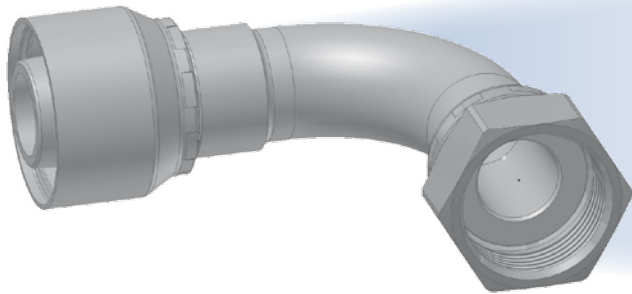

Approved fitting series for hose types:

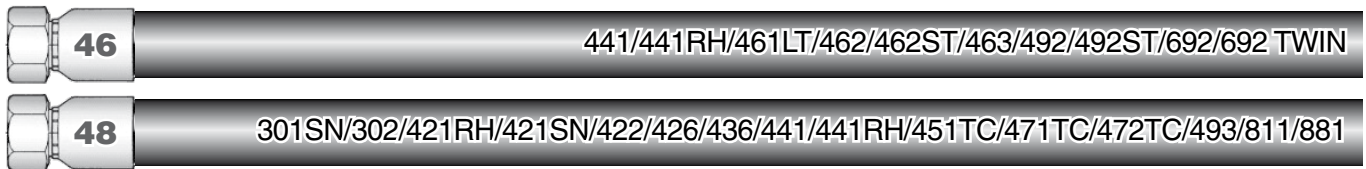

XXXX-XX-XX Part Number		Hose I.D.				Thread UNF	A mm	B mm	E mm	W mm
46	48	DN	Inch	Size	mm					
1J546-4-4	1J548-4-4	6	1/4	-4	6,3	9/16x18	59	35	32	17
1J546-6-4	1J548-6-4	6	1/4	-4	6,3	11/16x16	62	38	38	22
1J546-6-6	1J548-6-6	10	3/8	-6	9,5	11/16x16	58	35	38	22
1J546-8-6	1J548-8-6	10	3/8	-6	9,5	13/16x16	60	37	41	24
1J546-8-8	1J548-8-8	12	1/2	-8	12,7	13/16x16	60	37	41	24
1J546-10-8	1J548-10-8	12	1/2	-8	12,7	1x14	66	43	47	30
1J546-10-10	1J548-10-10	16	5/8	-10	15,9	1x14	65	40	47	30
1J546-12-10	1J548-12-10	16	5/8	-10	15,9	1-3/16x12	71	45	58	36
1J546-12-12	1J548-12-12	20	3/4	-12	19,1	1-3/16x12	80	54	58	36
1J546-16-12	1J548-16-12	20	3/4	-12	19,1	1-7/16x12	88	62	71	41
1J546-16-16	1J548-16-16	25	1	-16	25,4	1-7/16x12	98	68	71	41

Material: steel chromium(VI) free plated

Information about standard products or non-standard products can be found in the current price list. Dimensions shown may be changed at any time without prior notice.

JM – ORFS Male

ISO 12151-1-S – SAE J516

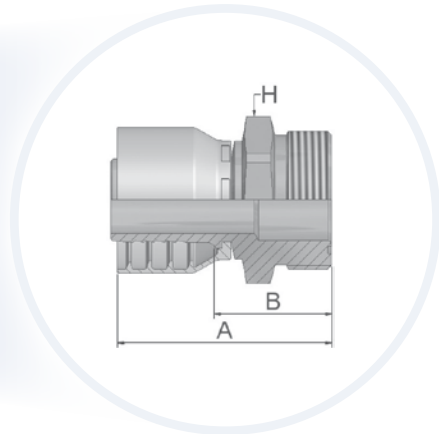
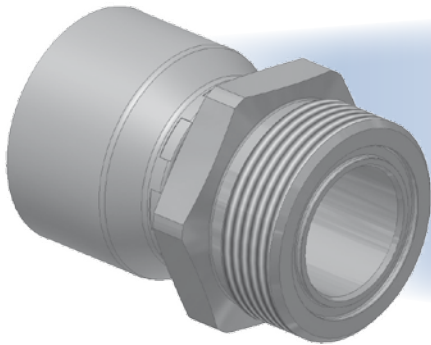

Approved fitting series for hose types:

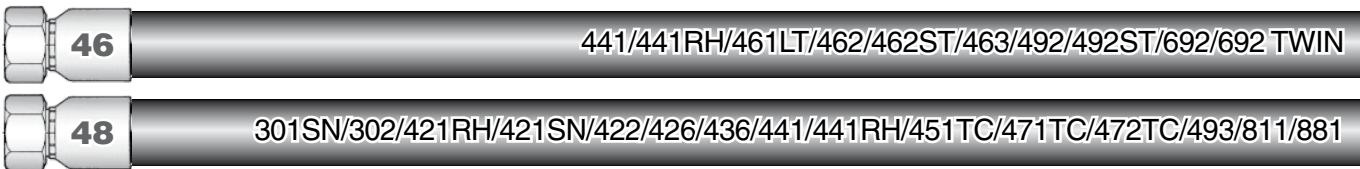

XXXX-XX-XX Part Number		Hose I.D.				Thread UNF	A mm	B mm	H mm
46	48	DN	Inch	Size	mm				
1JM46-4-4	1JM48-4-4	6	1/4	-4	6,3	9/16x18	46	22	17
1JM46-6-4	1JM48-6-4	6	1/4	-4	6,3	11/16x16	48	24	19
1JM46-6-5	1JM48-6-5	8	5/16	-5	7,9	11/16x16	50	26	19
1JM46-6-6	1JM48-6-6	10	3/8	-6	9,5	11/16x16	47	24	19
1JM46-8-6	1JM48-8-6	10	3/8	-6	9,5	13/16x16	50	27	22
1JM46-8-8	1JM48-8-8	12	1/2	-8	12,7	13/16x16	51	27	22
1JM46-10-8	1JM48-10-8	12	1/2	-8	12,7	1x14	55	32	27
1JM46-10-10	1JM48-10-10	16	5/8	-10	15,9	1x14	57	32	27
1JM46-12-10	1JM48-12-10	16	5/8	-10	15,9	1-3/16x12	59	34	32
1JM46-12-12	1JM48-12-12	20	3/4	-12	19,1	1-3/16x12	61	35	32
1JM46-16-12	1JM48-16-12	20	3/4	-12	19,1	1-7/16x12	64	38	41
1JM46-16-16	1JM48-16-16	25	1	-16	25,4	1-7/16x12	67	37	41
1JM46-20-16	1JM48-20-16	25	1	-16	25,4	1-11/16x12	66	36	46
1JM46-20-20		32	1-1/4	-20	31,8	1-11/16x12	76	38	46
	1JM48-20-20	32	1-1/4	-20	31,8	1-11/16x12	85	37	46
	1JM48-24-20	32	1-1/4	-20	31,8	2x12	87	40	55

For O-ring dimensions and part-numbers see Section Eb.
Material: steel chromium(VI) free plated

Information about standard products or non-standard products can be found in the current price list.
Dimensions shown may be changed at any time without prior notice.

JD – Male ORFS – Bulkhead with Locknut – Straight (with O-ring)

ISO 12151-1 – SAE J516

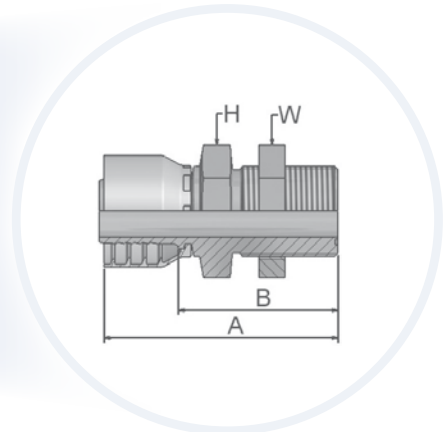
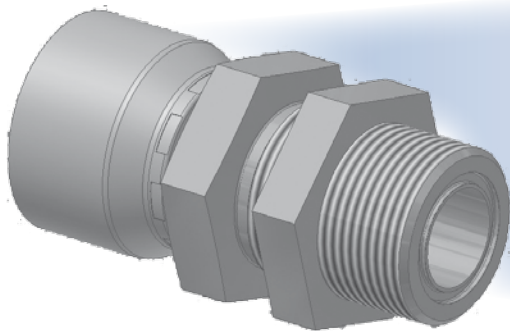

Approved fitting series for hose types:

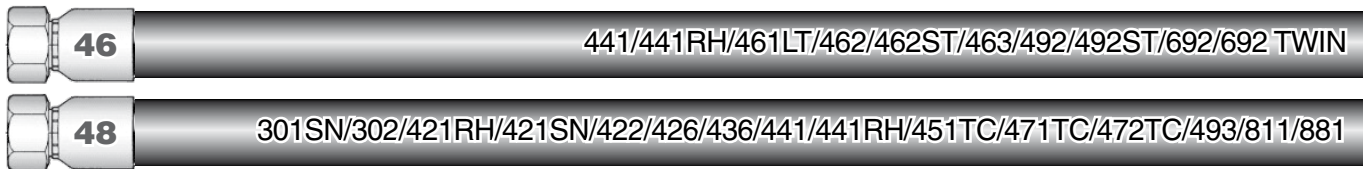

XXXX-XX-XX Part Number		Hose I.D.				Thread UNF	A mm	B mm	H mm	W mm
46	48	DN	Inch	Size	mm					
1JD46-4-4	1JD48-4-4	6	1/4	-4	6,3	9/16x18	72	48	22	22
1JD46-6-6	1JD48-6-6	10	3/8	-6	9,5	11/16x16	74	51	27	27
1JD46-8-8	1JD48-8-8	12	1/2	-8	12,7	13/16x16	79	56	30	30
1JD46-10-10	1JD48-10-10	16	5/8	-10	15,9	1x14	86	60	32	36
1JD46-12-12	1JD48-12-12	20	3/4	-12	19,1	1-3/16x12	89	63	36	38
1JD46-16-16	1JD48-16-16	25	1	-16	25,4	1-7/16x12	94	64	46	46

For O-ring dimensions and part-numbers see Section Eb.
Material: steel chromium(VI) free plated

Information about standard products or non-standard products can be found in the current price list.
Dimensions shown may be changed at any time without prior notice.

FG – Male French Gas Series – Rigid – Straight (24° Cone)

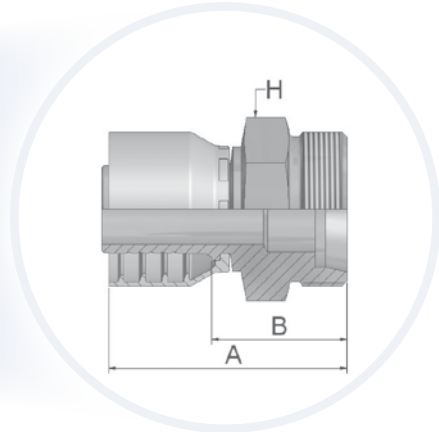
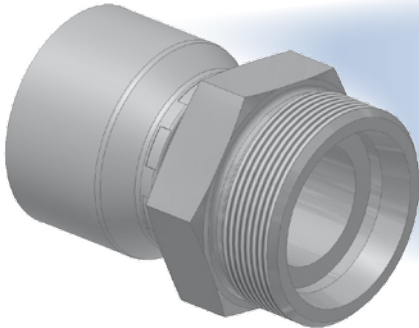

Approved fitting series for hose types:

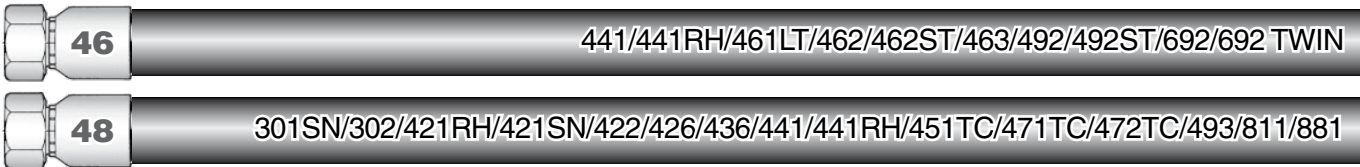

XXXX-XX-XX Part Number 46 48	Hose I.D.				Thread metric	Tube O.D. mm	A mm	B mm	H mm
	DN	Inch	Size	mm					
	1FG48-13-5	8	5/16	-5					
1FG48-13-6	10	3/8	-6	9,5	M20x1,5	13	52	29	22
1FG48-17-8	12	1/2	-8	12,7	M24x1,5	17	51	27	24
1FG48-21-10	16	5/8	-10	15,9	M30x1,5	21	58	32	30
1FG48-27-12	20	3/4	-12	19,1	M36x1,5	27	60	34	36
1FG48-33-16	25	1	-16	25,4	M45x1,5	33	69	40	46

Material: steel chromium(VI) free plated

Information about standard products or non-standard products can be found in the current price list. Dimensions shown may be changed at any time without prior notice.

F2 – Female French Swivel Female – Gas Series 90° Elbow

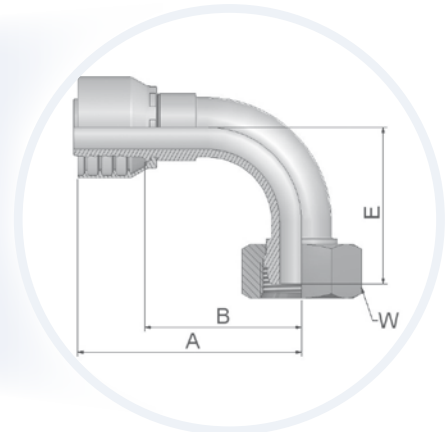
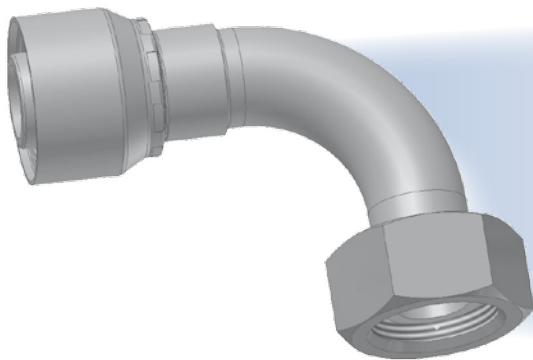

Approved fitting series for hose types:

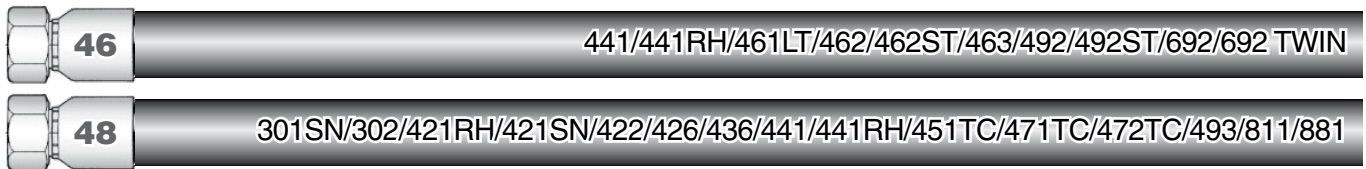

XXXX-XX-XX Part Number 46 48	Hose I.D.				Thread metric	Tube O.D.	A	B	E	W
	DN	Inch	Size	mm						
1F248-13-5	8	5/16	-5	7,9	M20x1,5	13	59	35	30	24
1F248-13-6	10	3/8	-6	9,5	M20x1,5	13	60	38	33	24
1F248-17-8	12	1/2	-8	12,7	M24x1,5	17	61	37	43	30
1F248-21-10	16	5/8	-10	15,9	M30x1,5	21	71	46	45	36

Material: steel chromium(VI) free plated

Information about standard products or non-standard products can be found in the current price list. Dimensions shown may be changed at any time without prior notice.

49 – Metric Banjo – Straight

DIN 7642

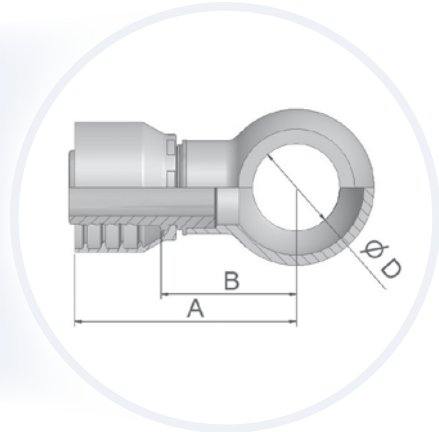
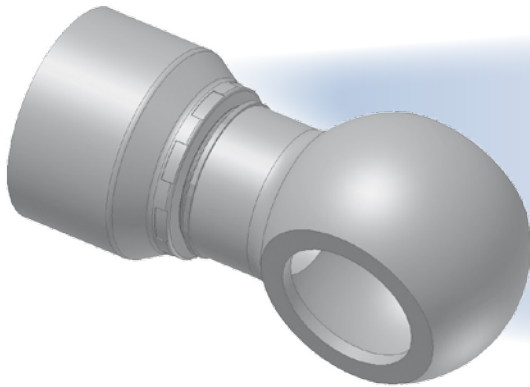

Approved fitting series for hose types:

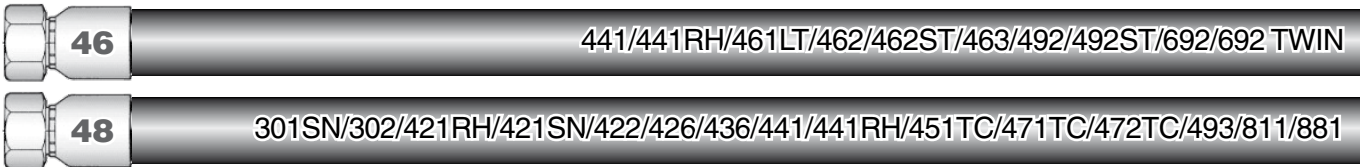

XXXX-XX-XX Part Number 46 48	Hose I.D. DN Inch Size mm	D mm	A mm	B mm				
14946-10-4	14948-10-4	6	1/4	-4	6,3	10	47	24
14946-12-4	14948-12-4	6	1/4	-4	6,3	12	50	26
14946-14-4	14948-14-4	6	1/4	-4	6,3	14	51	28
14946-17-4	14948-17-4	6	1/4	-4	6,3	17	52	29
14946-14-5	14948-14-5	8	5/16	-5	7,9	14	52	28
14946-16-5	14948-16-5	8	5/16	-5	7,9	16	53	30
14946-16-6	14948-16-6	10	3/8	-6	9,5	16	53	30
14946-17-6	14948-17-6	10	3/8	-6	9,5	17	53	30
14946-18-6	14948-18-6	10	3/8	-6	9,5	18	55	32
14946-22-6	14948-22-6	10	3/8	-6	9,5	22	58	35
14946-18-8	14948-18-8	12	1/2	-8	12,7	18	56	32
14946-22-8	14948-22-8	12	1/2	-8	12,7	22	59	35
14946-22-10	14948-22-10	16	5/8	-10	15,9	22	60	35
14946-26-12	14948-26-12	20	3/4	-12	19,1	26	66	40
14946-27-12	14948-27-12	20	3/4	-12	19,1	27	66	40
	14948-30-16	25	1	-16	25,4	30	77	47

To select corresponding screw and seals see section Eb.
Material: steel chromium(VI) free plated



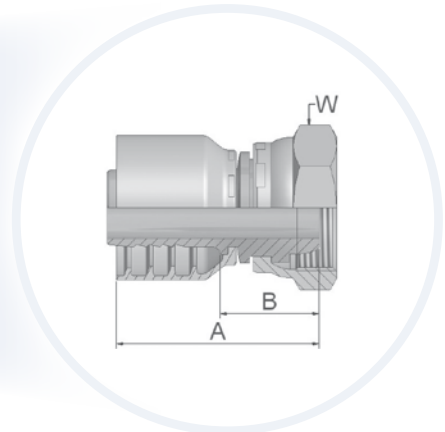
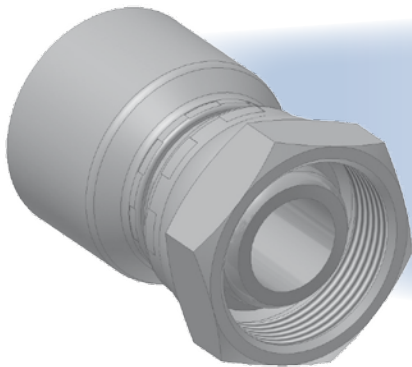

Information about standard products or non-standard products can be found in the current price list.
Dimensions shown may be changed at any time without prior notice.

F4 – Female French Gas Series – Swivel – Straight (Ball Nose)

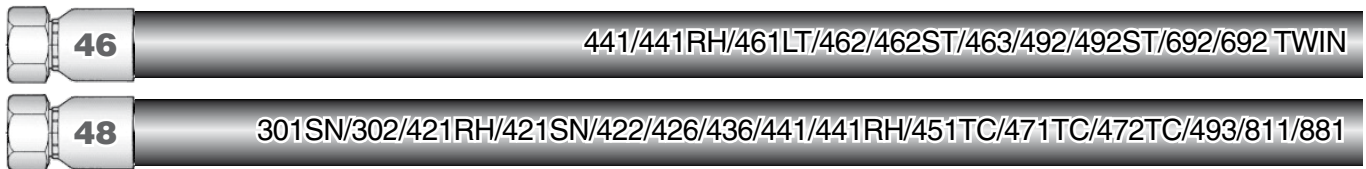

Approved fitting series for hose types:



XXXX-XX-XX Part Number  	 Hose I.D.				 Thread metric	Tube O.D.	A	B	 W
	DN	Inch	Size	mm					
1F448-13-4	6	1/4	-4	6,3	M20x1,5	13	48	24	24
1F448-13-5	8	5/16	-5	7,9	M20x1,5	13	48	24	24
1F446-13-6	10	3/8	-6	9,5	M20x1,5	13	46	23	24
1F448-17-6	10	3/8	-6	9,5	M24x1,5	17	50	27	30
1F448-13-8	12	1/2	-8	12,7	M20x1,5	13	46	22	24
1F446-17-8	12	1/2	-8	12,7	M24x1,5	17	49	25	30
1F446-21-10	16	5/8	-10	15,9	M30x1,5	21	50	25	36
1F448-21-12	20	3/4	-12	19,1	M30x1,5	21	51	25	36
1F448-27-12	20	3/4	-12	19,1	M36x1,5	27	59	33	46
1F448-33-16	25	1	-16	25,4	M45x1,5	33	63	33	55

Assembly with Parkrimp 2 machine only.
Material: steel chromium(VI) free plated

Information about standard products or non-standard products can be found in the current price list.
Dimensions shown may be changed at any time without prior notice.

F6 – French Male Metric Series (24° Cone)

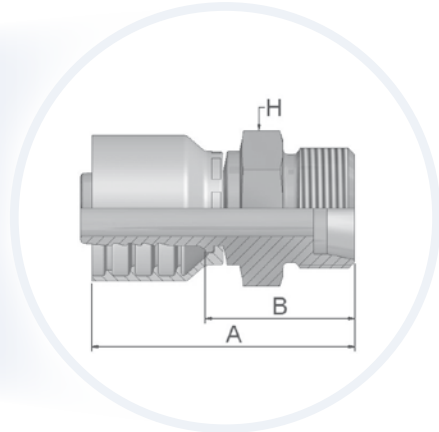
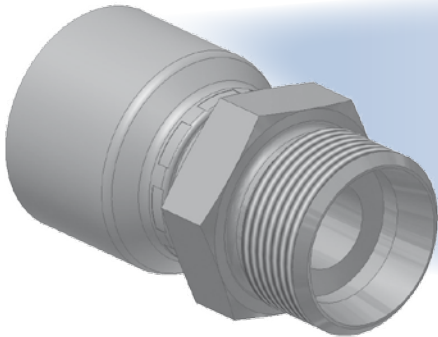

Approved fitting series for hose types:

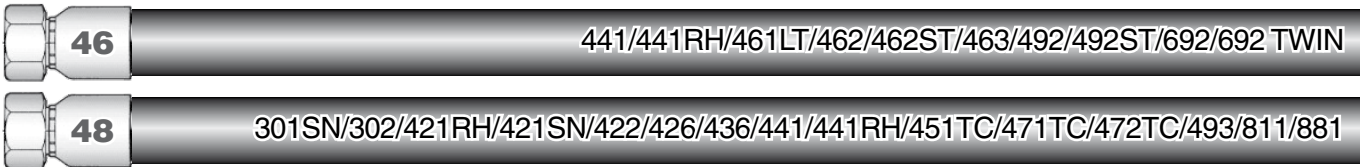

XXXX-XX-XX Part Number 46 48	Hose I.D.				Thread metric	Tube O.D.	A	B	H
	DN	Inch	Size	mm					
1F648-14-6	10	3/8	-6	9,5	M20x1,5	14	50	27	22
1F648-20-10	16	5/8	-10	15,9	M27x1,5	20	59	33	30

Material: steel chromium(VI) free plated

Information about standard products or non-standard products can be found in the current price list. Dimensions shown may be changed at any time without prior notice.

F9 – French Swivel Female Metric Series – (Ball Nose)

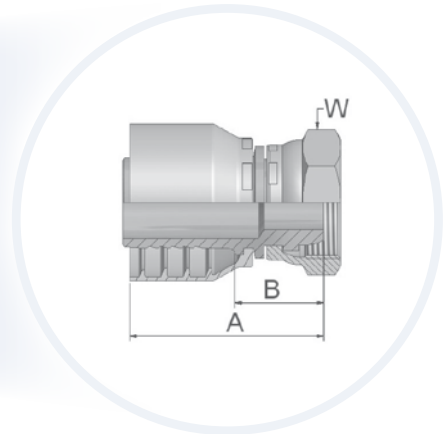
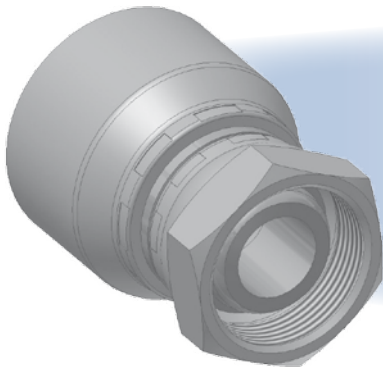

Approved fitting series for hose types:

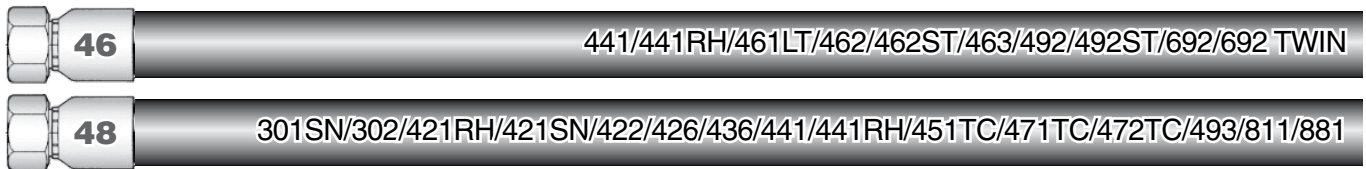

XXXX-XX-XX Part Number 46 48	Hose I.D.				Thread metric	Tube O.D.	A	B	W
	DN	Inch	Size	mm					
1F948-6-4	6	1/4	-4	6,3	M12x1	6	44	20	14
1F948-10-4	6	1/4	-4	6,3	M16x1,5	10	46	22	19
1F948-14-6	10	3/8	-6	9,5	M20x1,5	14	45	22	24
1F948-18-10	16	5/8	-10	15,9	M27x1,5	18	50	25	32
1F948-20-10	16	5/8	-10	15,9	M27x1,5	20	50	25	32
1F948-22-12	20	3/4	-12	19,1	M30x1,5	22	54	28	36
1F948-25-12	20	3/4	-12	19,1	M33x1,5	25	56	30	41
1F948-30-16	25	1	-16	25,4	M39x1,5	30	62	32	50

Material: steel chromium(VI) free plated

Information about standard products or non-standard products can be found in the current price list. Dimensions shown may be changed at any time without prior notice.

FA – Metric Male for Agricultural Valves

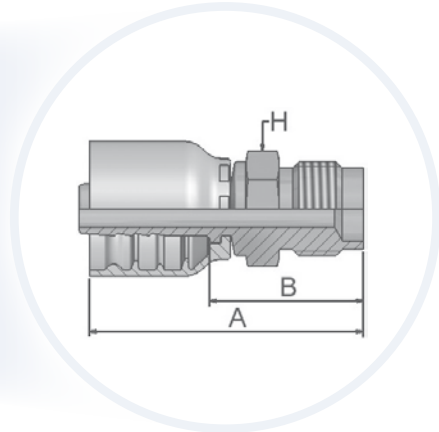
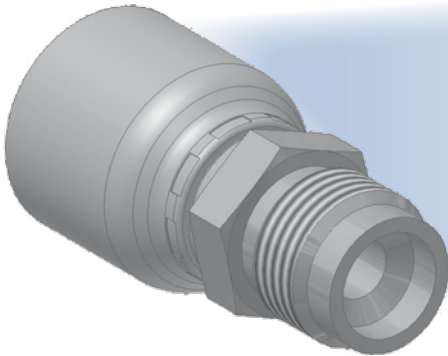

Approved fitting series for hose types:

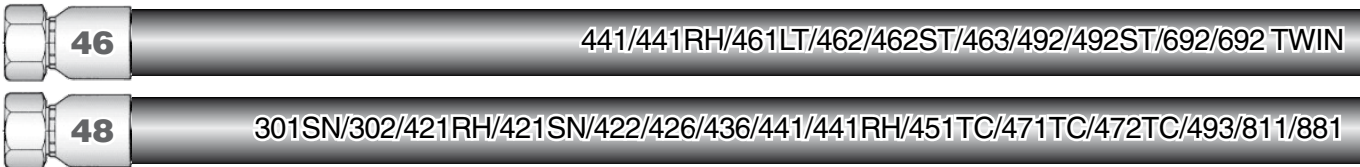

XXXX-XX-XX Part Number 46 48	Hose I.D.				Thread metric	A mm	B mm	H mm
	DN	Inch	Size	mm				
1FA48-12-5	8	5/16	-5	7,9	M18x1,5	53	29	19
1FA48-12-6	10	3/8	-6	9,5	M18x1,5	52	29	19
1FA48-12-8	12	1/2	-8	12,7	M18x1,5	53	29	19

Material: steel chromium(VI) free plated

Information about standard products or non-standard products can be found in the current price list. Dimensions shown may be changed at any time without prior notice.

FU – Female BSP Parallel Pipe – Swivel – Straight (30° Flare)

ISO 228-1 – JIS B8363 – GUI

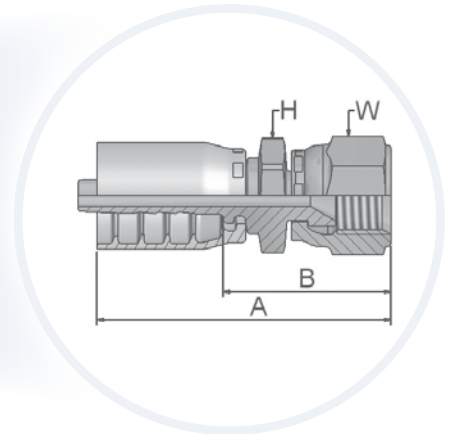
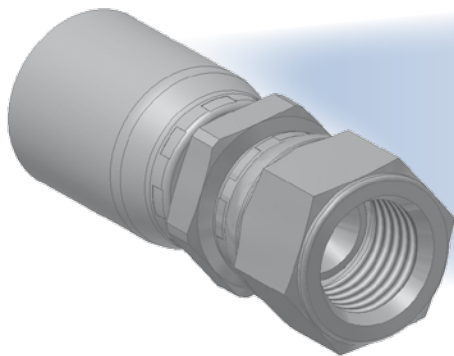

Approved fitting series for hose types:

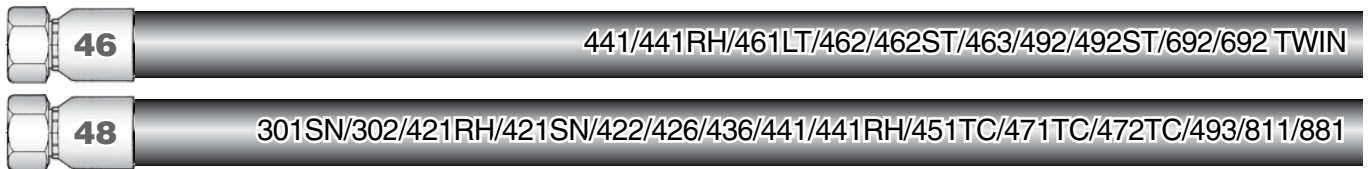

XXXX-XX-XX Part Number		Hose I.D.				Thread BSP	A mm	B mm	H mm	W mm
46	48	DN	Inch	Size	mm					
1FU46-4-4	1FU48-4-4	6	1/4	-4	6,3	1/4x19	53	29	19	19
	1FU48-4-6	10	3/8	-6	9,5	1/4x19	47	24	19	19
1FU46-6-6	1FU48-6-6	10	3/8	-6	9,5	3/8x19	46	23	24	22
1FU46-8-8	1FU48-8-8	12	1/2	-8	12,7	1/2x14	61	38	27	27
1FU46-12-12	1FU46-12-12	20	3/4	-12	19,1	3/4x14	68	42	36	36
1FU46-16-16	1FU48-16-16	25	1	-16	25,4	1x11	76	46	41	41

Material: steel chromium(VI) free plated

Information about standard products or non-standard products can be found in the current price list.
Dimensions shown may be changed at any time without prior notice.

GU – Female BSP Parallel Pipe – Swivel – Straight (60° Cone)

ISO 228-1 – JIS B8363 – GUO

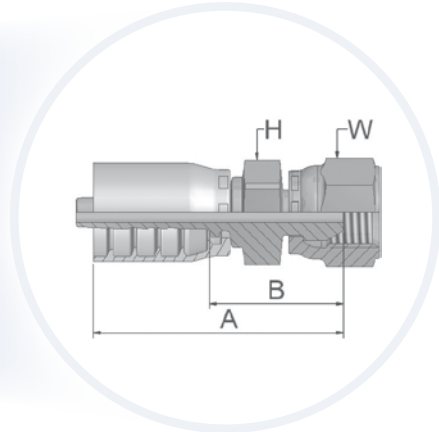
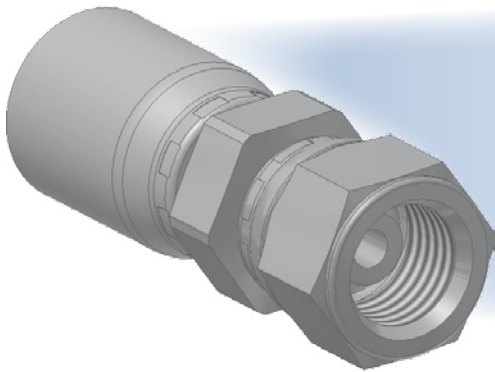

Approved fitting series for hose types:

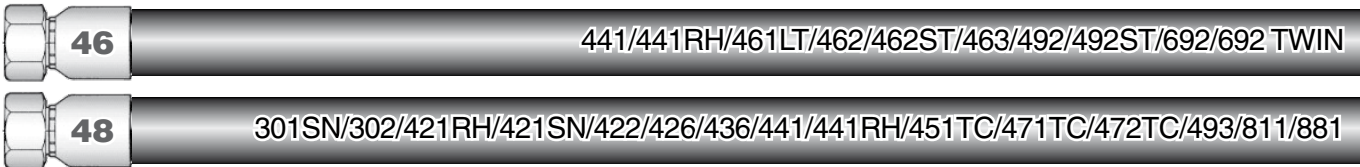

XXXX-XX-XX Part Number		Hose I.D.				Thread BSP	A mm	B mm	H mm	W mm
46	48	DN	Inch	Size	mm					
1GU46-4-4	1GU48-4-4	6	1/4	-4	6,3	1/4x19	51	27	19	19
1GU46-6-6	1GU48-6-6	10	3/8	-6	9,5	3/8x19	52	29	22	22
1GU46-8-8	1GU48-8-8	12	1/2	-8	12,7	1/2x14	55	32	27	27

Material: steel chromium(VI) free plated

Information about standard products or non-standard products can be found in the current price list.
Dimensions shown may be changed at any time without prior notice.

MU – Female Metric – Swivel – Straight (30° Flare)

JIS B8363 – MU

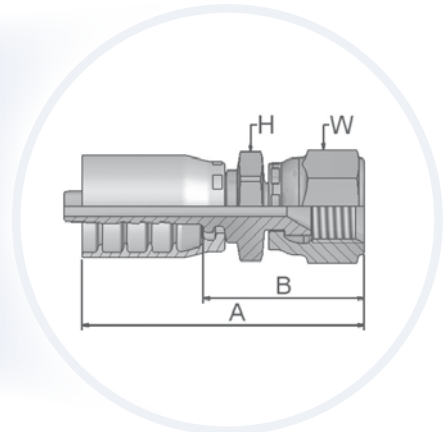
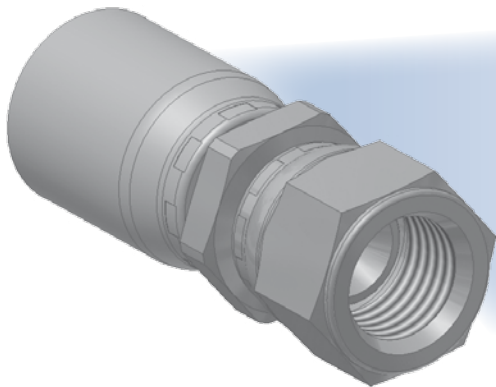

Approved fitting series for hose types:

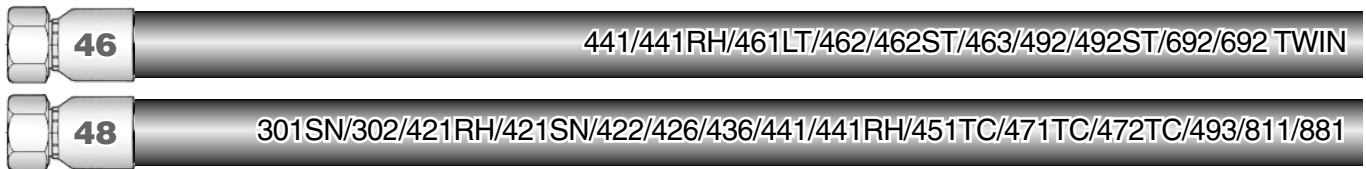

XXXX-XX-XX Part Number		Hose I.D.				Thread metric	A mm	B mm	H mm	W mm
46	48	DN	Inch	Size	mm					
1MU46-4-4	1MU48-4-4	6	1/4	-4	6,3	M14x1,5	45	21	19	19
1MU46-6-4	1MU48-6-4	6	1/4	-4	6,3	M18x1,5	57	33	24	24
1MU46-6-6	1MU48-6-6	10	3/8	-6	9,5	M18x1,5	46	23	24	24
1MU46-8-8	1MU48-8-8	12	1/2	-8	12,7	M22x1,5	51	27	27	27

Material: steel chromium(VI) free plated

Information about standard products or non-standard products can be found in the current price list. Dimensions shown may be changed at any time without prior notice.

MZ – Female Metric – Swivel – 90° Elbow (30° Flare)

JIS B8363

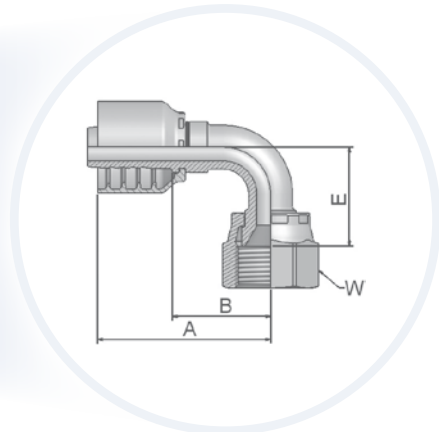
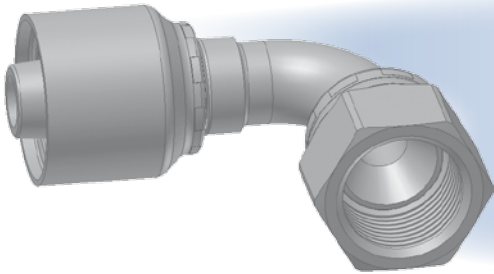

Approved fitting series for hose types:

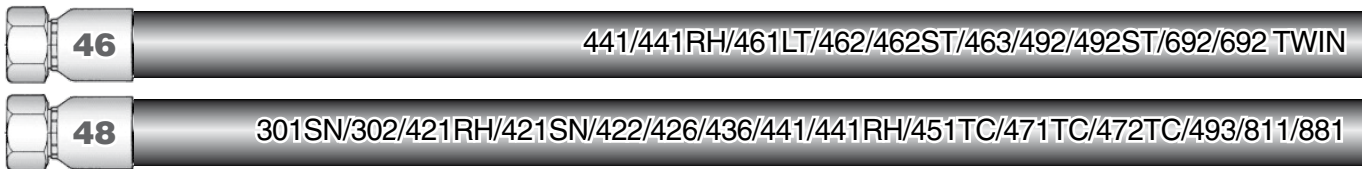

XXXX-XX-XX Part Number		Hose I.D.				Thread metric	A	B	E	W
46	48	DN	Inch	Size	mm					
1MZ46-4-4	1MZ48-4-4	6	1/4	-4	6,3	M14x1,5	48	24	23	19
1MZ46-6-6	1MZ48-6-6	10	3/8	-6	9,5	M18x1,5	51	28	29	24
1MZ46-8-8	1MZ48-8-8	12	1/2	-8	12,7	M22x1,5	55	31	31	27

Material: steel chromium(VI) free plated

Information about standard products or non-standard products can be found in the current price list. Dimensions shown may be changed at any time without prior notice.

UT – Male BSP Taper Pipe – Rigid – Straight (60° Cone)

JIS B 8363-R

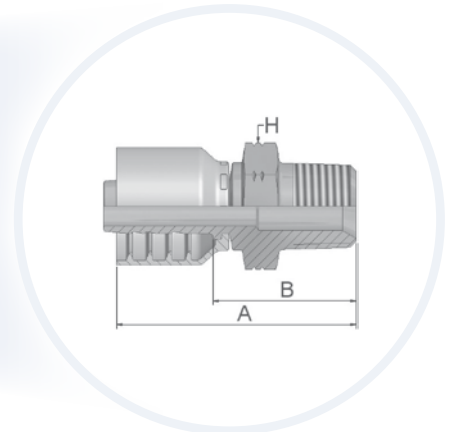
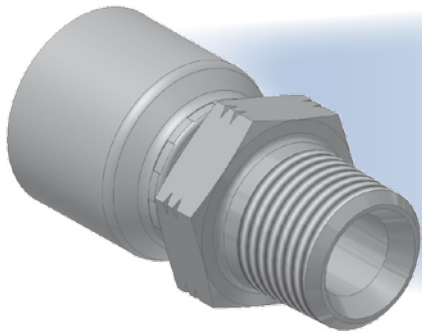

Approved fitting series for hose types:

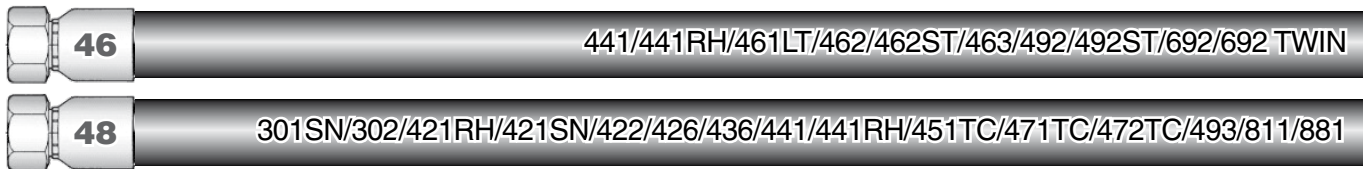

XXXX-XX-XX Part Number		Hose I.D.				Thread BSP	A mm	B mm	H mm
46	48	DN	Inch	Size	mm				
1UT46-4-4	1UT48-4-4	6	1/4	-4	6,3	1/4x19	51	27	19
1UT46-8-8	1UT48-8-8	12	1/2	-8	12,7	1/2x14	59	36	27

Material: steel chromium(VI) free plated

Information about standard products or non-standard products can be found in the current price list.
Dimensions shown may be changed at any time without prior notice.

XU – Female Metric – Swivel – Straight (30° Flare)

JIS B8363

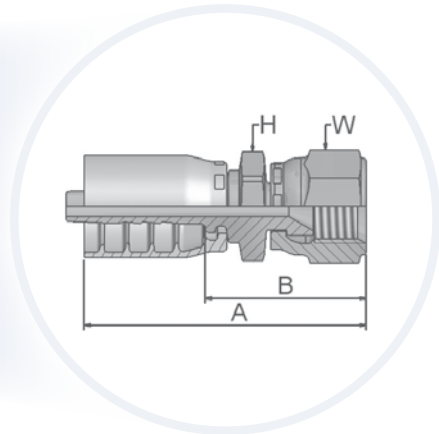
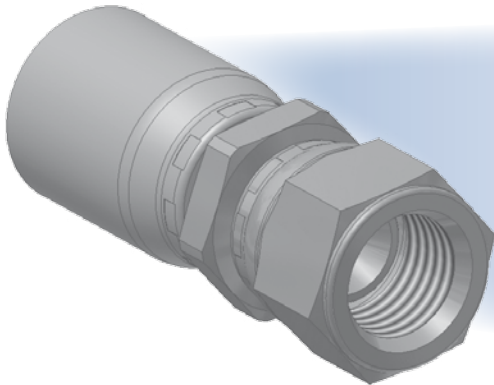

Approved fitting series for hose types:

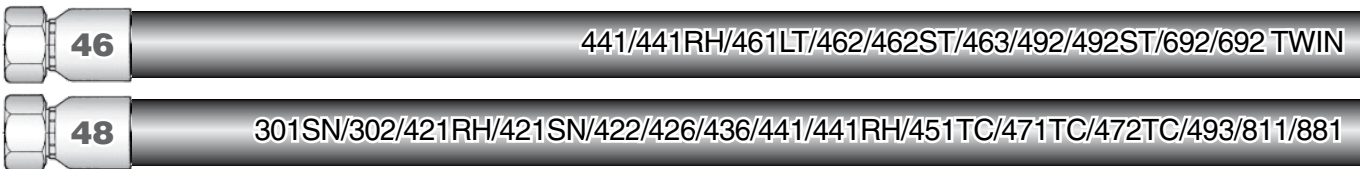

XXXX-XX-XX Part Number 46 48	Hose I.D.				Thread metric	A mm	B mm	H mm	W mm
	DN	Inch	Size	mm					
1XU48-10-10	16	5/8	-10	15,9	M24x1,5	69	44	30	32
1XU48-12-12	20	3/4	-12	19,1	M30x1,5	73	47	32	36
1XU48-16-16	25	1	-16	25,4	M33x1,5	90	61	36	41

Material: steel chromium(VI) free plated

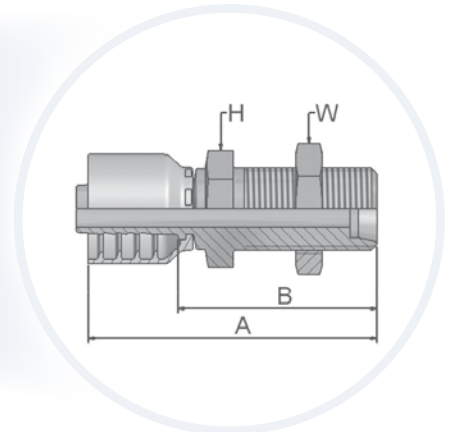
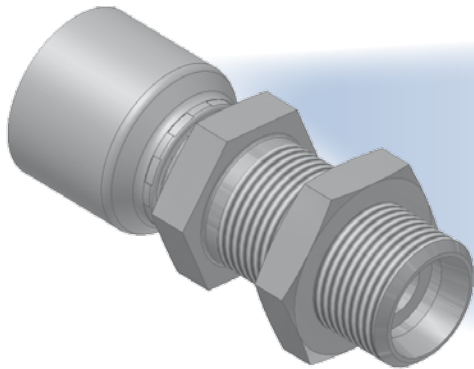

Information about standard products or non-standard products can be found in the current price list. Dimensions shown may be changed at any time without prior notice.

DK – Male Metric L – Rigid – Bulkhead with Locknut (24° Cone)

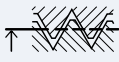

Approved fitting series for hose types:

46	441/441RH/461LT/462/462ST/463/492/492ST/692/692 TWIN
48	301SN/302/421RH/421SN/422/426/436/441/441RH/451TC/471TC/472TC/493/811/881

XXXX-XX-XX Part Number		 Hose I.D.				 Thread metric	A	B	 H	 W
46	48	DN	Inch	Size	mm		mm	mm	mm	mm
1DK46-12-6	1DK48-12-6	10	3/8	-6	9,5	M18x1,5	75	52	24	24
1DK46-18-10	1DK48-18-10	16	5/8	-10	15,9	M26x1,5	85	60	32	36

Material: steel chromium(VI) free plated

Information about standard products or non-standard products can be found in the current price list.
Dimensions shown may be changed at any time without prior notice.

DX – Female Metric Swivel (M27x2) O-ring – Light Series

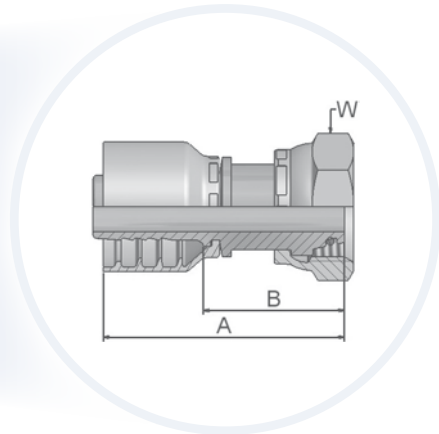
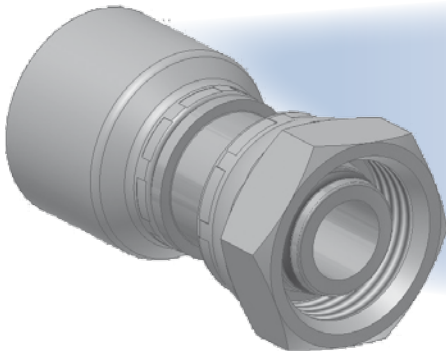

Approved fitting series for hose types:

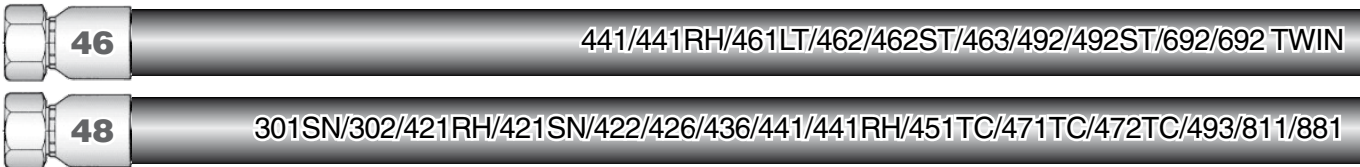

XXXX-XX-XX Part Number		Hose I.D.				Thread metric	A	B	W
46	48	DN	Inch	Size	mm		mm	mm	mm
1DX46-18-10	1DX48-18-10	16	5/8	-10	15,9	M27x2	61	36	32

Material: steel chromium(VI) free plated

Information about standard products or non-standard products can be found in the current price list. Dimensions shown may be changed at any time without prior notice.

CW – Power Cleaner Connection

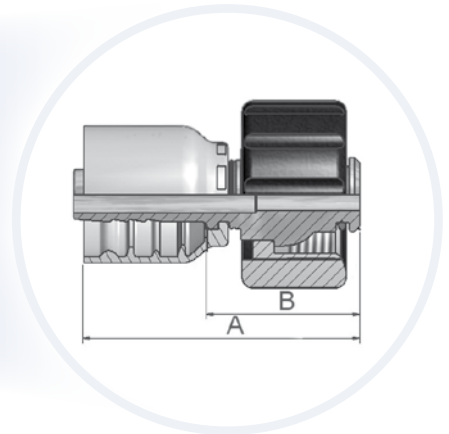

Approved fitting series for hose types:

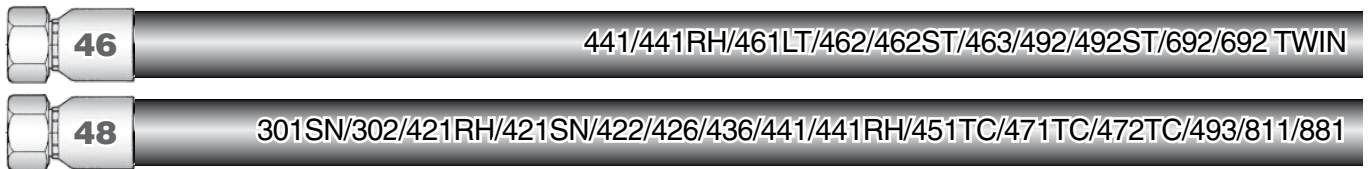

XXXX-XX-XX Part Number		Hose I.D.				Thread metric	Tube O.D. mm	A mm	B mm
46	48	DN	Inch	Size	mm				
1CW46-15-4	1CW48-15-4	6	1/4	-4	6,3	M22x1,5	15	53	29
1CW46-15-5	1CW48-15-5	8	5/16	-5	7,9	M22x1,5	15	53	29
1CW46-15-6	1CW48-15-6	10	3/8	-6	9,5	M22x1,5	15	52	29
1CW46-15-8	1CW48-15-8	12	1/2	-8	12,7	M22x1,5	15	53	29

Rubber hand grip Part-No. WKS-X-XXX in black or blue please find on page Eb-12.
Material: steel chromium(VI) free plated

Information about standard products or non-standard products can be found in the current price list.
Dimensions shown may be changed at any time without prior notice.

NW – Female Kärcher Metric Cleaning Hose Fitting – Swivel – Straight
(New Design)

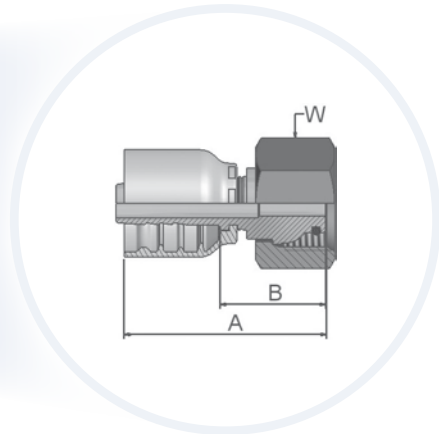
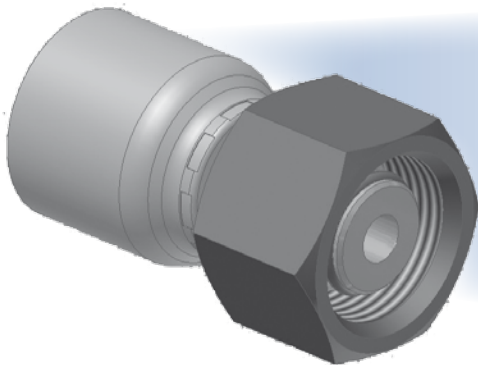

Approved fitting series for hose types:

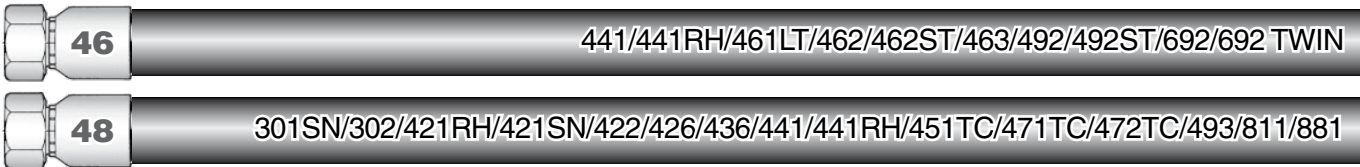

XXXX-XX-XX Part Number		Hose I.D.				Thread metric	Tube O.D. mm	A mm	B mm
46	48	DN	Inch	Size	mm				
1NW46-15-4	1NW48-15-4	6	1/4	-4	6,3	M22x1,5	15	52	29
1NW46-15-5	1NW48-15-5	8	5/16	-5	7,9	M22x1,5	15	52	29
1NW46-15-6	1NW48-15-6	10	3/8	-6	9,5	M22x1,5	15	48	25

Rubber hand grip Part-No. WKS-X-XXX in black or blue please find on page Eb-12.
Material: steel chromium(VI) free plated

Information about standard products or non-standard products can be found in the current price list.
Dimensions shown may be changed at any time without prior notice.

PW – Male Kärcher Metric Cleaning Hose Fitting – Rigid – Straight

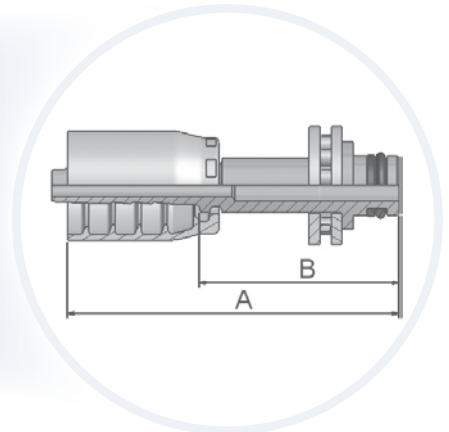
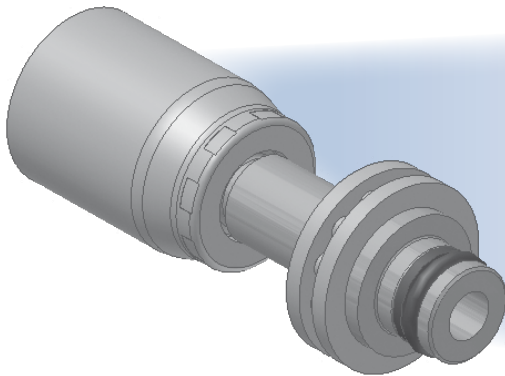

Approved fitting series for hose types:

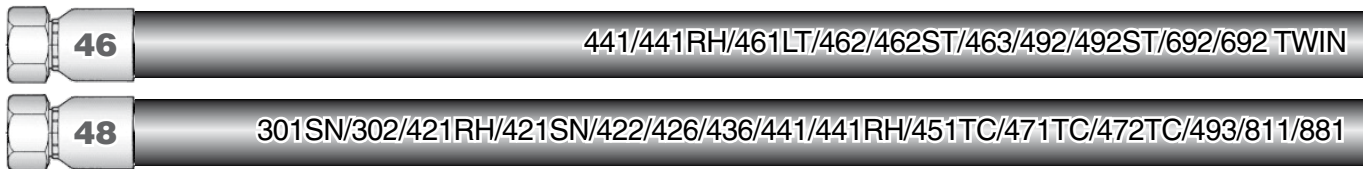

XXXX-XX-XX Part Number		 Hose I.D.				Tube O.D.	A	B
46	48	DN	Inch	Size	mm	mm	mm	mm
1PW46-10-4	1PW48-10-4	6	1/4	-4	6,3	10	60	36
1PW46-11-4*	1PW48-11-4*	6	1/4	-4	6,3	11	61	37
1PW46-10-5	1PW48-10-5	8	5/16	-5	7,9	10	60	36
1PW46-11-5*	1PW48-11-5*	8	5/16	-5	7,9	11	61	37
1PW46-10-6	1PW48-10-6	10	3/8	-6	9,5	10	60	37

* equipped with a bearing
 Rubber hand grip Part-No. WKS-X-XXX in black or blue please find on page Eb-12.
 Material: steel chromium(VI) free plated

Information about standard products or non-standard products can be found in the current price list.
 Dimensions shown may be changed at any time without prior notice.



aerospace
climate control
electromechanical
filtration
fluid & gas handling
hydraulics
pneumatics
process control
sealing & shielding



Hydraulic Hose, Fittings and Equipment

High Pressure



ENGINEERING YOUR SUCCESS.

High Pressure Hydraulic Hose and Fittings

- the heavy duty performers

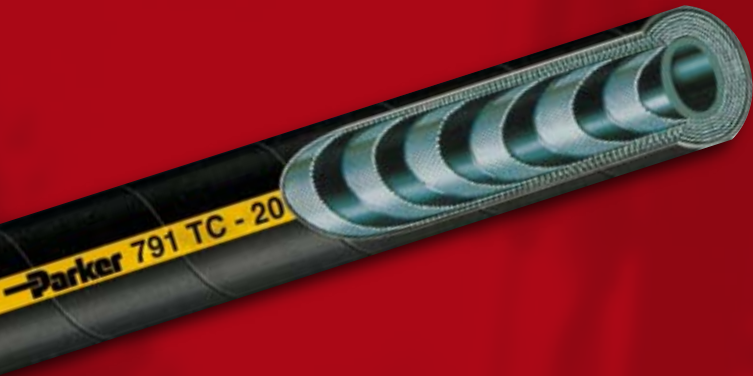

Apart from excellent high-pressure performance, the multispiral hose and fittings range offers the following advantages:

- ▶ Specially engineered shells guarantee optimum compression and grip of the fitting on the hose
- ▶ *No-Skive* design eliminates the need to remove the hose cover before crimping
- ▶ Manufactured from a single piece of steel, Parker monobloc fittings eliminate potential leak paths
- ▶ The hose range is available with high abrasion resistant TC or ST covers, prolonging hose life.
- ▶ Low volumetric expansion at maximum working pressure.
- ▶ Wide fluid compatibility.

As the hydraulic market moves towards higher working pressures and flow volumes, multispiral hoses are playing an ever-increasingly important role in machine design.

Parker, as the worldwide market leader in *No-Skive* hose technology, meets these requirements by offering a full range of *No-Skive* multispiral hose and fittings up to 42,0 MPa.

The range covers hoses according to ISO, EN and SAE standards in sizes from -6 up to -32 and is accompanied by a full range of matching one-piece monobloc fittings manufactured from high-grade steel.

All hose and fitting combinations are thoroughly tested and approved according to Parker standards that exceed those of internationally accepted bodies such as ISO.



Parkrimp® No-Skive

The system for fast and leak-free assemblies

- No skiving tool needed
- No need to remove the cover
- Crimps one piece fittings
- Parkalign positions the fittings in the die perfectly every time
- Quick and easy: no gauges to set on the machine
- Portable machines for field repair
- Meets EN safety regulations

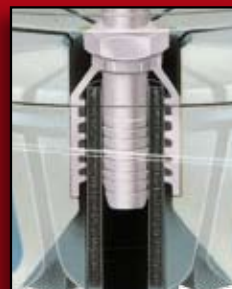

Parkalign®
Parker's exclusive Parkalign® positions the fitting in the dies perfectly every time.

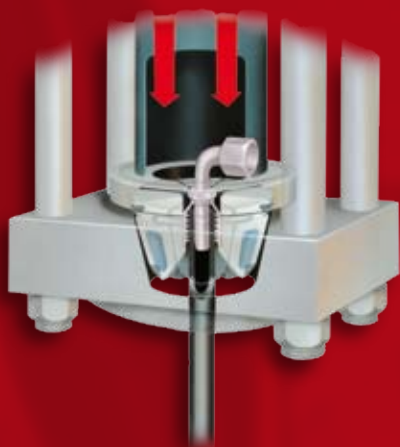

Parker's colour-coded die sets

No loose parts to mismatch or misplace – die set segments linked together. Die sets provide 360° evenly applied crimping forces for an ideal crimp result.



The perfect match

The complete system from one source. *No-Skive* hose, *No-Skive* fitting and crimping machine with world-wide guarantee and availability.



The definitive hose range for all high pressure applications



Index

371LT	– <i>No-Skive</i> Low Temperature 3 Wire Hose EN 856-4SP Pressures	Da-1
372	– <i>No-Skive</i> 3 Wire Hose EN 856-4SP Pressures	Da-2
372RH	– <i>No-Skive</i> Compact - Fire-retardant Cover	Da-3
372TC	– <i>No-Skive</i> 3 Wire TOUGH COVER Hose EN 856-4SP Pressures . . .	Da-4
701	– <i>No-Skive</i> Multispiral EN 856-4SP Hose	Da-5
721TC	– <i>No-Skive</i> Multispiral EN 856-R12 TOUGH COVER Hose . .	Da-6
731	– <i>No-Skive</i> Multispiral EN 856-4SH Hose	Da-7
774	– <i>No-Skive</i> Multispiral Phosphate Ester Hose	Da-8
781	– <i>No-Skive</i> Multispiral EN 856-R13 Hose	Da-9
P35	– <i>No-Skive</i> Multispiral EN 856-R13 Hose	Da-10
791TC	– <i>No-Skive</i> Multispiral SAE 100 R15 TOUGH COVER Hose	Da-11
792TC	– <i>No-Skive</i> Multispiral SAE 100 R15 TOUGH COVER Hose	Da-12
Crimp Fittings: 70 Series		Db-1–Db-36
Crimp Fittings: 71 Series		Dc-1–Dc-29
Crimp Fittings: 73 Series		Dd-1–Dd-24
Crimp Fittings: 78 Series		De-1–De-28
Crimp Fittings: 79 Series		Df-1–Df-9
Crimp Fittings: S6 Series		Dg-1–Dg-8

371LT – No-Skive Compact Hose

3 wire braid Low Temperature Compact hose with 4SP working pressures

Main Features

- *No-Skive* hose construction – Compact design
- Excellent ozone resistance
- Temperature range from -50 °C up to +100 °C

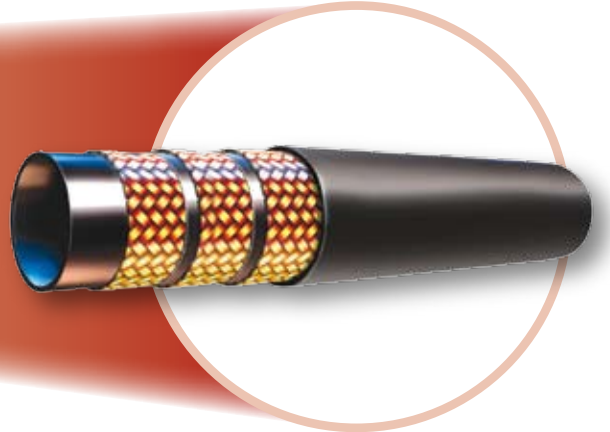

Primary Applications/Restrictions

Mobile applications in low temperature environments:
Forestry machines, refrigerated warehouses

Applicable Specifications

Parker Specifications

Hose Construction

Tube: Synthetic rubber
Reinforcement: Three high tensile steel wire braids
Cover: Synthetic rubber

Recommended Fluids

Petroleum and water-glycol based fluids, lubricating oils, air and water. For air above 1,7 MPa, the hose cover must be pin-pricked.

Consult the chemical compatibility section on page Ab-16 for more detailed information.

Temperature Range

-50 °C up to +100 °C
Exception: Air max. +70 °C
Water max. +85 °C

Fittings Series



XXXX-XX-XX Part Number	Hose I.D.				Hose O.D.	Pressure rating				min. bend radius mm	Weight kg/m
	DN	Inch	Size	mm	mm	max. dynamic working pressure		min. burst pressure			
						MPa	psi	MPa	psi		
371LT-6	10	3/8	-6	9,5	21,4	44,5	6500	178,0	26000	120	0,73
371LT-8	12	1/2	-8	12,7	24,6	41,5	6000	166,0	24000	160	0,90
371LT-10	16	5/8	-10	15,9	28,2	35,0	5000	140,0	20000	210	1,09
371LT-12	20	3/4	-12	19,1	32,2	35,0	5000	140,0	20000	260	1,36
371LT-16	25	1	-16	25,4	39,7	28,0	4000	112,0	16000	310	1,78

The combination of high temperature and high pressure could reduce the hose life.

Information about standard products or non-standard products can be found in the current price list. Dimensions shown may be changed at any time without prior notice.

372 – *No-Skive* Compact Hose

3 wire braid Compact hose with 4SP working pressures

Main Features

- *No-Skive* hose construction – Compact design
- Nitrile (NBR) inner tube for extended fluid compatibility
- Type approved with DNV, GL, LR

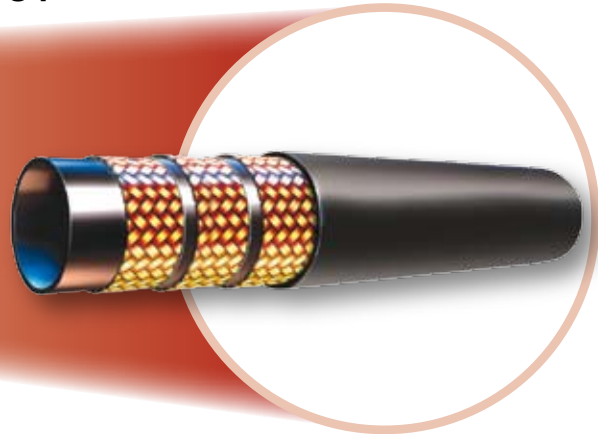

Primary Applications/Restrictions

General high pressure small bending radii hydraulic applications

Applicable Specifications

Parker Specifications

Hose Construction

- Tube:** Nitrile (NBR)
Reinforcement: Three high tensile steel wire braids
Cover: Synthetic rubber

Recommended Fluids

Petroleum and water-glycol based fluids, lubricating oils, air and water. For air above 1,7 MPa, the hose cover must be pin-pricked.

Consult the chemical compatibility section on page Ab-16 for more detailed information.

Temperature Range

- 40 °C up to +100 °C
 Exception: Air max. +70 °C
 Water max. +85 °C

Fittings Series



Part Number XXXX-XX-XX	Hose I.D.				Hose O.D.	Pressure rating				min. bend radius mm	Weight kg/m
	Size				mm	max. dynamic working pressure		min. burst pressure			
	DN	Inch		mm	mm	MPa	psi	MPa	psi		
372-6	10	3/8	-6	9,5	21,4	44,5	6500	180,0	25800	120	0,73
372-8	12	1/2	-8	12,7	24,6	41,5	6000	166,0	24000	160	0,90
372-10	16	5/8	-10	15,9	28,2	35,0	5000	140,0	20000	210	1,09
372-12	20	3/4	-12	19,1	32,2	35,0	5000	140,0	20000	260	1,36
372-16	25	1	-16	25,4	39,7	28,0	4000	112,0	16000	310	1,78

The combination of high temperature and high pressure could reduce the hose life.

Information about standard products or non-standard products can be found in the current price list. Dimensions shown may be changed at any time without prior notice.

372RH – *No-Skive* Compact Hose

with fire-retardant cover

Main Features

- *No-Skive* hose construction – Compact design
- Nitrile (NBR) inner tube
– high chemical resistance
- Small bend radii
- Suitable with 70 series fittings
- Fire-retardant cover

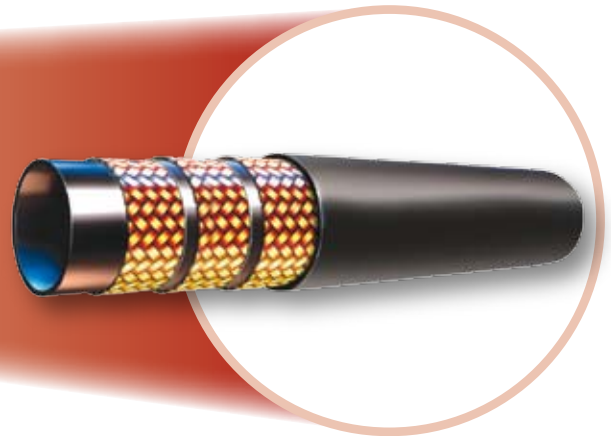

Certifications

- German Standard: DIN 5510-2
- French Standard: NF F16-101/102 I2/F3
- British Standard: BS 6853 - Table 4

Primary Applications

Dynamic and static high-pressure hydraulic systems

Applicable Specifications

Parker specifications

Working pressure and O.D. to EN 856 – 4 SP

Hose Construction

- Tube:** Nitrile (NBR)
Reinforcement: Three high tensile steel wire braids
Cover: Fire retardant synthetic rubber

Recommended Fluids

Petroleum and water-glycol based fluids, lubricating oils, air and water. For air and gas above 1,7 MPa, the hose cover must be pin-pricked.

Consult the chemical compatibility section on page Ab-16 for more detailed information.

Temperature Range

-40 °C up to +100 °C
 Exception: Air max. +70 °C
 Water max. +85 °C

Fitting Series



Part Number XXXX-XX-XX	Hose I.D.				Hose O.D.	Pressure rating				min. bend radius mm	Weight kg/m
						max. dynamic working pressure		min. burst pressure			
	DN	Inch	Size	mm	mm	MPa	psi	MPa	psi		
372RH-6	10	3/8	-6	9,5	21,4	44,5	6500	180,0	25800	120	0,73
372RH-8	12	1/2	-8	12,7	24,6	41,5	6000	166,0	24000	160	0,90
372RH-10	16	5/8	-10	15,9	28,2	35,0	5000	140,0	20000	210	1,09
372RH-12	20	3/4	-12	19,1	32,2	35,0	5000	140,0	20000	260	1,36
372RH-16	25	1	-16	25,4	39,7	28,0	4000	112,0	16000	310	1,78

The combination of high temperature and high pressure could reduce the hose life.

Information about standard products or non-standard products can be found in the current price list. Dimensions shown may be changed at any time without prior notice.

372TC – *No-Skive* Compact Hose

3 wire braid Compact hose with 4SP working pressures

Main Features

- *No-Skive* hose construction – Compact design
- Nitrile (NBR) inner tube for greater fluid compatibility
- **TOUGH COVER** offers 80 times more abrasion resistance than standard cover and offers exceptional protection from hose-to-hose or hose-to-object abrasion

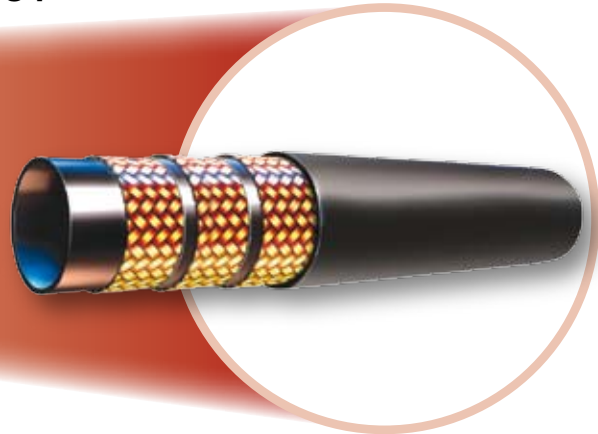

Primary Applications/Restrictions

General high pressure hydraulic applications (typically in the mobile industry)

Applicable Specifications

Parker specifications – working pressures and outside diameters according to EN 856 - 4SP

Hose Construction

- Tube:** Nitrile (NBR)
Reinforcement: Three high tensile steel wire braids
Cover: Highly abrasion resistant, MSHA approved synthetic rubber

Recommended Fluids

Petroleum and water-glycol based fluids, lubricating oils, air and water. For air above 1,7 MPa, the hose cover must be pin-pricked. Consult the chemical compatibility section in catalogue 4400 on page Ab-16 for more detailed information.

The **TOUGH COVER** hose is suitable for immersion in mineral oils up to 70 °C.

Temperature Range

- 40 °C up to +100 °C
 Exception: Air max. +70 °C
 Water max. +85 °C

Fittings Series

70

Part Number XXXX-XX-XX	Hose I.D.				Hose O.D.	Pressure rating				min. bend radius mm	Weight kg/m
	DN	Inch	Size	mm	mm	max. dynamic working pressure		min. burst pressure			
						MPa	psi	MPa	psi		
372TC-6	10	3/8	-6	9,5	21,4	44,5	6500	180,0	25800	120	0,73
372TC-8	12	1/2	-8	12,7	24,6	41,5	6000	166,0	24000	160	0,90
372TC-10	16	5/8	-10	15,9	28,2	35,0	5000	140,0	20000	210	1,09
372TC-12	20	3/4	-12	19,1	32,2	35,0	5000	140,0	20000	260	1,36
372TC-16	25	1	-16	25,4	39,7	28,0	4000	112,0	16000	310	1,78

The combination of high temperature and high pressure could reduce the hose life.

Information about standard products or non-standard products can be found in the current price list. Dimensions shown may be changed at any time without prior notice.

701 – No-Skive Spiral Hose

ISO 3862-1 Type 4SP, EN 856 Type 4SP

Main Features

- *No-Skive* hose construction
- Reinforcement of four high tensile steel wires

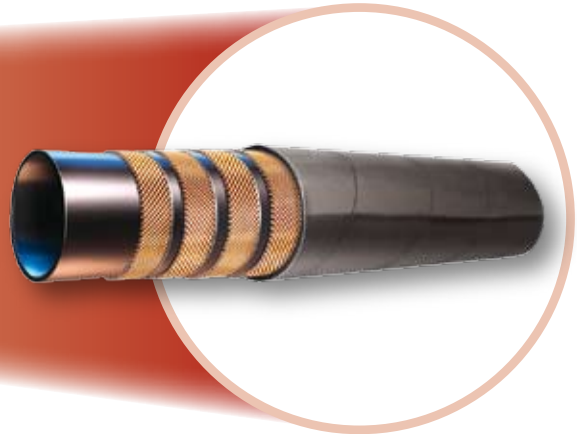

Primary Applications/Restrictions

General high pressure hydraulic applications

Applicable Specifications

ISO 3862-1 type 4SP, EN 856 type 4SP

Hose Construction

Tube: Synthetic rubber
Reinforcement: Four spirals of high-tensile steel wire
Cover: Synthetic rubber

Recommended Fluids

Petroleum and water-glycol based fluids, lubricating oils, air and water. For air above 1,7 MPa, the hose cover must be pin-pricked.

Consult the chemical compatibility section on page Ab-16 for more detailed information.

Temperature Range

-40 °C up to +100 °C

Exception: Air max. +70 °C
 Water max. +85 °C

Fittings Series

70

XXXX-XX-XX Part Number	Hose I.D.				Hose O.D.	Pressure rating				min. bend radius mm	Weight kg/m
						max. dynamic working pressure		min. burst pressure			
	DN	Inch	Size	mm	mm	MPa	psi	MPa	psi		
701-6	10	3/8	-6	9,5	21,4	45,0	6500	180,0	26000	180	0,78
701-8	12	1/2	-8	12,7	24,6	41,5	6000	166,0	24000	230	0,93
701-10	16	5/8	-10	15,9	28,2	35,0	5000	140,0	20000	250	1,15
701-12	20	3/4	-12	19,1	32,2	35,0	5000	140,0	20000	300	1,58
701-16	25	1	-16	25,4	39,7	28,0	4000	112,0	16000	340	2,04
701-20	32	1-1/4	-20	31,8	50,3	21,0	3000	84,0	12000	460	3,32
701-24	40	1-1/2	-24	38,1	56,7	18,5	2700	74,0	10800	560	3,70

The combination of high temperature and high pressure could reduce the hose life.

Information about standard products or non-standard products can be found in the current price list. Dimensions shown may be changed at any time without prior notice.

721TC = *No-Skive* Spiral Hose

SAE 100R12 – EN 856 Type R12 – ISO 3862-1 Type R12

Main Features

- *No-Skive* hose construction
- Abrasion resistant **TOUGH COVER**
- Half SAE 100R12 specified minimum bend radius
- MSHA accepted cover

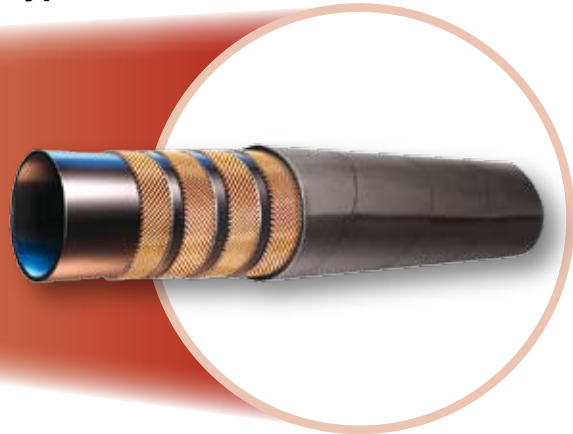

Primary Applications/Restrictions

High-pressure extremely small bending radii applications

Applicable Specifications

SAE 100R12, EN 856 Type R12, ISO 3862-1 Type R12

Hose Construction

- Tube:** Synthetic rubber
- Reinforcement:** Four spirals of high-tensile steel wire
- Cover:** High abrasion-resistant synthetic rubber

Recommended Fluids

Petroleum and water-glycol based fluids, lubricating oils, air and water. For air above 1,7 MPa, the hose cover must be pin-pricked.

Consult the chemical compatibility section on page Ab-16 for more detailed information.

Temperature Range

- 40 °C up to +125°C
- Exception: Air max. +70 °C
- Water max. +85°C

Fittings Series



XXXX-XX-XX Part Number	Hose I.D.				Hose O.D. mm	Pressure rating				min. bend radius mm	Weight kg/m
	DN	Inch	Size	mm		max. dynamic working pressure		min. burst pressure			
						MPa	psi	MPa	psi		
721TC-6	10	3/8	-6	9,5	20,0	28,0	4000	112,0	16000	65	0,59
721TC-8	12	1/2	-8	12,7	24,0	28,0	4000	112,0	16000	90	0,80
721TC-10	16	5/8	-10	15,9	27,0	28,0	4000	112,0	16000	100	1,10
721TC-12	20	3/4	-12	19,1	31,0	28,0	4000	112,0	16000	120	1,40
721TC-16	25	1	-16	25,4	38,0	28,0	4000	112,0	16000	150	1,99
721TC-20	32	1-1/4	-20	31,8	47,0	21,0	3000	84,0	12000	210	2,59
721TC-24	40	1-1/2	-24	38,1	53,0	17,5	2500	70,0	10000	250	2,99
721TC-32	50	2	-32	50,8	67,0	17,5	2500	70,0	10000	320	4,09

The combination of high temperature and high pressure could reduce the hose life.

Information about standard products or non-standard products can be found in the current price list. Dimensions shown may be changed at any time without prior notice.

731 – No-Skive Spiral Hose

ISO 3862-1 Type 4SH, EN 856 Type 4SH

Main Features

- *No-Skive* hose construction
- Reinforcement of four high tensile steel wires

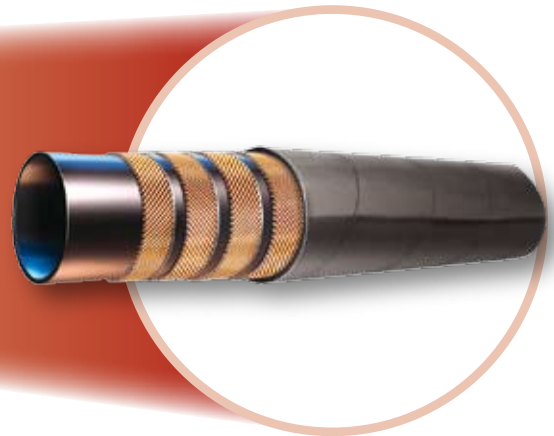

Primary Applications/Restrictions

General high pressure hydraulic applications

Applicable Specifications

ISO 3862-1 type 4SH, EN 856 type 4SH

Hose Construction

- Tube:** Synthetic rubber
Reinforcement: Four spirals of high-tensile steel wire
Cover: Synthetic rubber

Recommended Fluids

Petroleum and water-glycol based fluids, lubricating oils, air and water. For air above 1,7 MPa, the hose cover must be pin-pricked.

Consult the chemical compatibility section on page Ab-16 for more detailed information.

Temperature Range

-40 °C up to +100 °C

Exception: Air max. +70 °C
 Water max. +85 °C

Fittings Series

73

XXXX-XX-XX Part Number	Hose I.D.				Hose O.D.	Pressure rating				min. bend radius mm	Weight kg/m
	DN	Inch	Size	mm	mm	max. dynamic working pressure		min. burst pressure			
						MPa	psi	MPa	psi		
731-12	20	3/4	-12	19,1	32,0	42,0	6000	168,0	24000	280	1,72
731-16	25	1	-16	25,4	39,0	38,0	5500	152,0	22000	340	2,14
731-20	32	1-1/4	-20	31,8	45,0	32,0	4700	130,0	18800	460	2,96
731-24	40	1-1/2	-24	38,1	53,0	29,0	4200	116,0	16800	560	3,20
731-32	50	2	-32	50,8	68,0	25,0	3600	100,0	14400	700	5,30

The combination of high temperature and high pressure could reduce the hose life.

Information about standard products or non-standard products can be found in the current price list. Dimensions shown may be changed at any time without prior notice.

774 - No-Skive Spiral Hose

For phosphate ester base fluids

Main Features

- *No-Skive* hose construction
- Phosphate ester and weather resistant, green, EPDM synthetic rubber cover

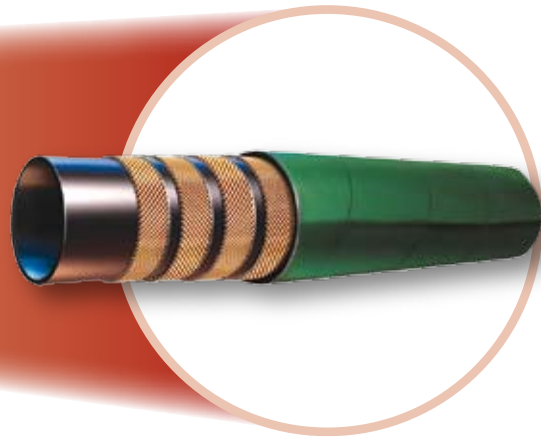

Primary Applications/Restrictions

Testbenches for aerospace, foundries, steel mills
 High pressure hydraulic applications with phosphate ester fluids
Do not allow tube to contact any petroleum base fluids.
Use liquid soap as hose lubricant.

Applicable Specifications

Parker specifications

Hose Construction

- Tube:** Phosphate ester resistant EPDM synthetic rubber
- Reinforcement:** Four spirals of high-tensile steel wire
- Cover:** Phosphate ester and weather resistant, green, EPDM synthetic rubber cover.

Recommended Fluids

Phosphate ester base hydraulic fluids
 Consult the chemical compatibility section on page Ab-16 for more detailed information.

Temperature Range -40 °C up to +80 °C

Fittings Series



Part Number XXXX-XX-XX	Hose I.D.				Hose O.D. mm	Pressure rating				min. bend radius mm	Weight kg/m
	Hose I.D.					max. dynamic working pressure		min. burst pressure			
	DN	Inch	Size	mm		MPa	psi	MPa	psi		
774-12	20	3/4	-12	19,1	31,0	28,0	4000	112,0	16000	240	1,40
774-16	25	1	-16	25,4	38,0	28,0	4000	112,0	16000	300	1,99
774-20	32	1-1/4	-20	31,8	47,0	21,0	3000	84,0	12000	420	2,59
774-24	40	1-1/2	-24	38,1	53,0	17,5	2500	70,0	10000	500	2,99
774-32	50	2	-32	50,8	67,0	17,5	2500	70,0	10000	630	4,09

The combination of high temperature and high pressure could reduce the hose life.

Information about standard products or non-standard products can be found in the current price list.
 Dimensions shown may be changed at any time without prior notice.

781 - No-Skive Spiral Hose

SAE 100R13, ISO 3862-1 Type R13 and EN 856 Type R13

Main Features

- *No-Skive* hose construction
- Reinforcement of four or six high tensile steel wires
- Constant 35,0 MPa working pressure in all sizes

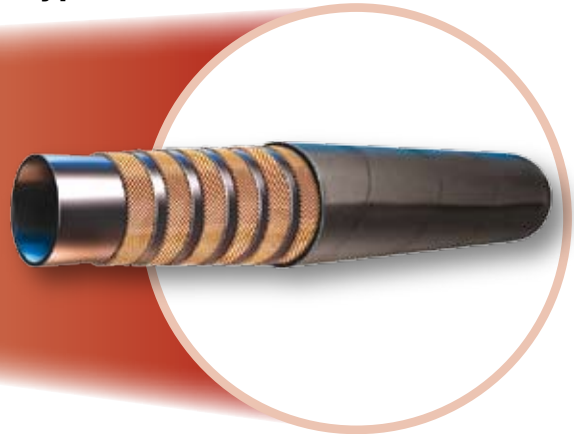

Primary Applications/Restrictions

General extremely high pressure hydraulic applications

Applicable Specifications

SAE 100R13, ISO 3862-1 Type R13, EN 856 Type R13

Hose Construction

Tube: Synthetic rubber
Reinforcement: Four- or six- spiral high-tensile steel wire
Cover: Synthetic rubber

Recommended Fluids

Petroleum and water-glycol based fluids, lubricating oils, air and water. For air above 1,7 MPa, the hose cover must be pin-pricked.

Consult the chemical compatibility section on page Ab-16 for more detailed information.

Temperature Range

-40 °C up to +125°C
 Exception: Airmax. +70 °C
 Watermax. +85°C

Fittings Series



XXXX-XX-XX Part Number	Hose I.D.				Hose O.D.	Pressure rating				min. bend radius mm	Weight kg/m
	DN	Inch	Size	mm	mm	max. dynamic working pressure		min. burst pressure			
						MPa	psi	MPa	psi		
781-12	20	3/4	-12	19,1	32,0	35,0	5000	140,0	20000	240	1,59
781-16	25	1	-16	25,4	39,0	35,0	5000	140,0	20000	300	2,20
781-20	32	1-1/4	-20	31,8	50,0	35,0	5000	140,0	20000	420	3,69
781-24	40	1-1/2	-24	38,1	57,0	35,0	5000	140,0	20000	500	4,79

The combination of high temperature and high pressure could reduce the hose life.

Information about standard products or non-standard products can be found in the current price list. Dimensions shown may be changed at any time without prior notice.

P35 – No-Skive Spiral Hose

SAE 100R13, ISO 3862-1 Type R13 and EN 856 Type R13

Main Features

- *No-Skive* hose construction
- Reinforcement of six high tensile steel wires
- Constant 35,0 MPa working pressure

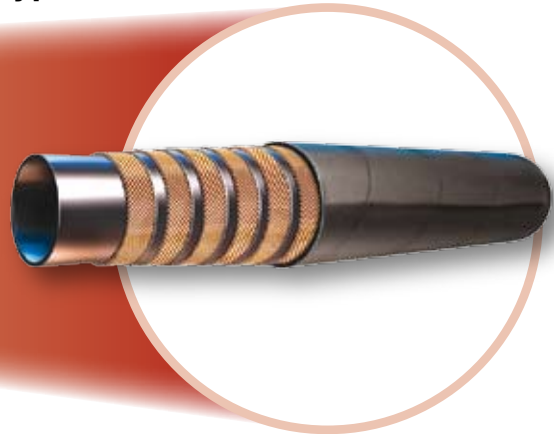

Primary Applications/Restrictions

Mobile/ industrial hydraulics:

General extremely high pressure large flow hydraulic applications

Applicable Specifications

SAE 100R13, ISO 3862-1 Type R13, EN 856 Type R13

Hose Construction

Tube: Synthetic rubber
Reinforcement: Six spiral high-tensile steel wire
Cover: Synthetic rubber

Recommended Fluids

Petroleum and water-glycol based fluids, lubricating oils, air and water. For air above 1,7 MPa, the hose cover must be pin-pricked.

Consult the chemical compatibility section on page Ab-16 for more detailed information.

Temperature Range

-40 °C up to +125°C

Exception: Air max. +70 °C
 Water max. +85°C

Fittings Series



Part Number	Hose I.D.				Hose O.D. mm	Pressure rating				min. bend radius mm	Weight kg/m
	DN	Inch	Size	mm		max. dynamic working pressure		min. burst pressure			
						MPa	psi	MPa	psi		
P35-32	50	2	-32	50,8	71,0	35,0	5000	140,0	20000	630	7,48

The combination of high temperature and high pressure could reduce the hose life.

Information about standard products or non-standard products can be found in the current price list. Dimensions shown may be changed at any time without prior notice.

791TC – *No-Skive* Spiral Hose

SAE 100R15 – ISO3862-1Type R15

Main Features

- *No-Skive* hose construction
- Abrasion resistant **TOUGH COVER**
- Constant 42,0 MPa working pressure

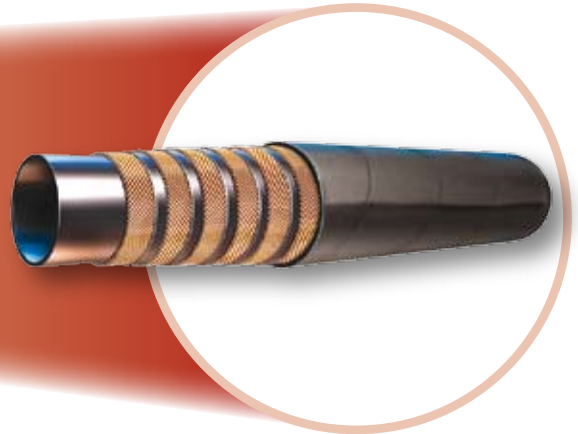

Primary Applications/Restrictions

Mobile hydraulics: Hydrostatic drives
General industrial hydraulics:
 Injection molding machines
 Test stands

Applicable Specifications

SAE 100R15 – ISO3862-1Type R15

Hose Construction

Tube: Synthetic rubber
Reinforcement: Four- or six- spiral high-tensile steel wire
Cover: High abrasion-resistant synthetic rubber

Recommended Fluids

Petroleum and water-glycol based fluids, lubricating oils, air and water. For air above 1,7 MPa, the hose cover must be pin-pricked.
 Consult the chemical compatibility section on page Ab-16 for more detailed information.

Temperature Range

-40 °C up to +125°C
 Exception: Air max. +70 °C
 Water max. +85°C

Fittings Series



XXXX-XX-XX Part Number	Hose I.D.				Hose O.D.	Pressure rating				min. bend radius mm	Weight kg/m
						max. dynamic working pressure		min. burst pressure			
	DN	Inch	Size	mm	mm	MPa	psi	MPa	psi		
791TC-12	20	3/4	-12	19,1	32,0	42,0	6000	168,0	24000	200	1,59
791TC-16	25	1	-16	25,4	39,0	42,0	6000	168,0	24000	250	2,20
791TC-20	32	1-1/4	-20	31,8	50,0	42,0	6000	168,0	24000	250	3,69
791TC-24	40	1-1/2	-24	38,1	57,0	42,0	6000	168,0	24000	305	4,79

The combination of high temperature and high pressure could reduce the hose life.

Information about standard products or non-standard products can be found in the current price list.
 Dimensions shown may be changed at any time without prior notice.

792TC = *No-Skive* Spiral Hose

SAE 100R15 – ISO3862-1 Type R15

Main Features

- *No-Skive* hose construction
- Abrasion resistant **TOUGH COVER**
- Constant 42,0 MPa working pressure
- Nitrile (NBR) inner tube for extended fluid compatibility

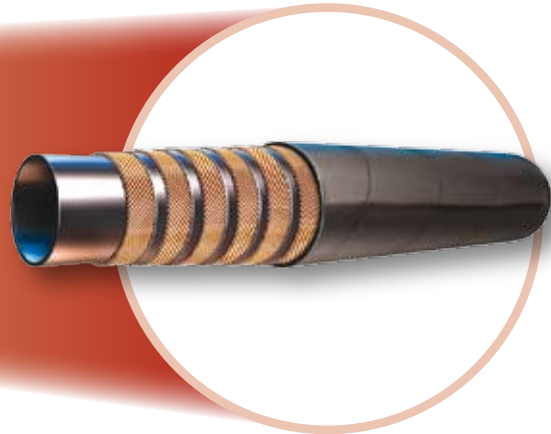

Primary Applications/Restrictions

Mobile hydraulics: Hydrostatic drives

General industrial hydraulics:

- Injection molding machines
- Test stands

Applicable Specifications

SAE 100R15 – ISO3862-1 Type R15

Hose Construction

- Tube:** Nitrile (NBR)
- Reinforcement:** Four- or six- spiral high-tensile steel wire
- Cover:** High abrasion-resistant synthetic rubber

Recommended Fluids

Petroleum and water-glycol based fluids, lubricating oils, air and water. For air above 1,7 MPa, the hose cover must be pin-pricked.

Consult the chemical compatibility section on page Ab-16 for more detailed information.

Temperature Range -40 °C up to +125°C

- Exception: Air max. +70 °C
Water max. +85°C

Fittings Series













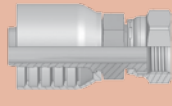
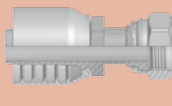
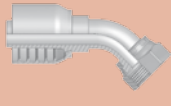
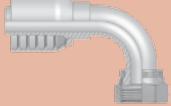

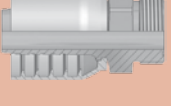

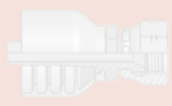

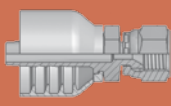
XXXX-XX-XX Part Number	Hose I.D.				Hose O.D.	Pressure rating				min. bend radius mm	Weight kg/m
						max. dynamic working pressure		min. burst pressure			
	DN	Inch	Size	mm	mm	MPa	psi	MPa	psi		
792TC-12	20	3/4	-12	19,1	32,0	42,0	6000	168,0	24000	265	1,59
792TC-16	25	1	-16	25,4	39,0	42,0	6000	168,0	24000	330	2,20

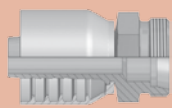

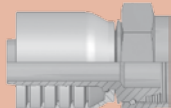







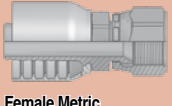

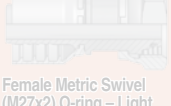







The combination of high temperature and high pressure could reduce the hose life.

Information about standard products or non-standard products can be found in the current price list. Dimensions shown may be changed at any time without prior notice.

Fittings Overview 70 Series

DIN	CA Db-1  DKOL	CE Db-2  DKOL 45°	CF Db-3  DKOL 90°	D0 Db-4  CEL	C0  DKM or DKLL	C3  DKL	C4  DKL 45°	
	C5  DKL 90°	1D  BEL	DD  BEL 45°	5D  BEL 90°	C9 Db-5  DKOS	0C Db-6  DKOS 45°	1C Db-7  DKOS 90°	
	D2 Db-8  CES	C6  DKS	3D  BES	49  Metric Banjo	9B  Swivel Female 45° Elbow	9C  Swivel Female 90° Elbow		
	92 Db-9  DKR	B1 Db-10  DKR 45°	B2 Db-11  DKR 90°	B4  DKR 90° (Compact)	EA Db-12  DKOR	EB  DKOR 45°	EC Db-13  DKOR 90°	
	D9 Db-14  AGR	91  AGR-K	B5  Female BSP Parallel Pipe - Swivel (Flat Seat)	34  Standpipe				
	01 Db-15  AGN	02  Female NPTF Pipe Rigid - Straight	03 Db-16  AGJ	04  Male SAE 45° - Rigid	05  Male SAE Straight Thread with O-ring - Rigid	06 Db-17 68  DKJ	08  AGS	
	13  Male NPTF Pipe Swivel	33  Male JIC 37° - Rigid	37 Db-18 3V  DKJ 45°	39 Db-19 3W  DKJ 90°	41 3Y  DKJ 90° L	L9  DKJ 90° M	93  Female JIC 37° - Swivel (Block Type)	
15 Db-20 4A  SFL	16  SFL 22.5°	17 Db-21 4F  SFL 45°	19 Db-22 4N  SFL 90°	6A Db-23  SFS	6F Db-24  SFS 45°	6N Db-25  SFS 90°		
89  SFL 90° - long	XA  Caterpillar Flange Head	XF  Caterpillar Flange Head 45°	XG  Caterpillar Flange Head 60°	XN  Caterpillar Flange Head 90°				

ORFS	JC Db-26  ORFS - short	JS Db-27  ORFS - long	J7 Db-28  ORFS 45°	J9 Db-29  ORFS Female 90°	J1 Db-30  ORFS 90° - extra long	J5  ORFS 90° - long	JM Db-31  ORFS Male
	JD  Male ORFS - Bulkhead with Locknut (with O-ring)						
JIS	FU  GUI	GU  GUO	MU Db-34  Female Metric Swivel - (30° Flare)	MZ  Female Metric Swivel - (30° Flare)	UT  Male BSP Taper Pipe Rigid - (60° Cone)		
	French Standard	FG Db-32  Male Rigid Gas Series - (24° Cone)	F2  Female Swivel Gas Series	F4 Db-33  Female Swivel Gas Series - (Ball Nose)	F6  Male Metric (24° Cone)	F9  Swivel Female Metric (Ball Nose)	FA  Metric Male for Agriculture Valves
High Pressure Cleaning		CW  Power Cleaner Connection	PW  Male Kärcher Metric Cleaning Hose Fitting - Rigid	NW  Female Kärcher Metric Cleaning Hose Fitting - (New Design)			

others	XU Db-35  Female Metric Swivel - (30° Flare)	XY Db-36  Female Metric Swivel - (30° Flare)	DK  Male Metric L - Rigid Bulkhead with Locknut (24° Cone)	DX  Female Metric Swivel (M27x2) O-ring - Light Series	FF  Metru-Lok Swivel Female	AF  Male BSP Parallel Pipe Rigid - Straight (with O-ring Seal)	NM  Male BSP Parallel Pipe - L Series - Rigid Straight - ED-Seal
	YW  Male Standpipe - Rigid - Straight - A-Lok	VW121  BSP Swivel Female	82  Push-Lok Union	DP  Metric Swivel Female Tee / Male Stud	DR  Metric Swivel Female Tee	5C  60° Cone Swivel Female	6C  60° Cone Swivel Female - 45° Elbow
	7C  60° Cone Swivel Female - 90° Elbow	5S  Female Tube O-ring Swivel - Short Pilot	5H  Female Tube O-ring Swivel - 45° Elbow Short Pilot	5T  Female Tube O-ring Swivel 90° Elbow Short Pilot	59PT  Male Tube O-ring Swivel - Long Pilot Charge Port at 180° for R134a	5LPT  Female Tube O-ring Swivel - 90° Elbow Long Pilot Charge Port at 180° for R134a	T1  Male Refrigerant Tube Mender - Straight (with Nut and Ferrule)



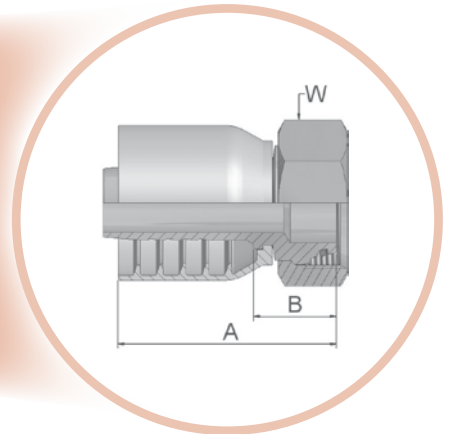
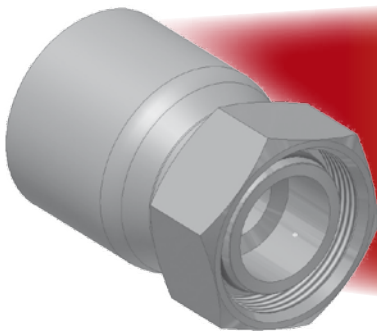

CA - Female Metric 24° - Light Series with O-ring - Swivel - Straight

ISO 12151-2-SWS-L - DKOL



Approved fitting series for hose types:



XXXX-XX-XX Part Number 	 Hose I.D.				 Thread metric	Tube O.D.	A	B	 W
	DN	Inch	Size	mm					
1CA70-10-6	10	3/8	-6	9,5	M16x1,5	10	53	24	19
1CA70-12-6	10	3/8	-6	9,5	M18x1,5	12	53	24	22
1CA70-15-8	12	1/2	-8	12,7	M22x1,5	15	62	27	27
1CA70-18-8	12	1/2	-8	12,7	M26x1,5	18	57	22	32
1CA70-15-10	16	5/8	-10	15,9	M22x1,5	15	64	27	27
1CA70-18-10	16	5/8	-10	15,9	M26x1,5	18	62	26	32
1CA70-22-10	16	5/8	-10	15,9	M30x2	22	64	24	36
1CA70-18-12	20	3/4	-12	19,1	M26x1,5	18	65	26	32
1CA70-22-12	20	3/4	-12	19,1	M30x2	22	63	24	36
1CA70-28-16	25	1	-16	25,4	M36x2	28	78	33	41
1CA70-35-16	25	1	-16	25,4	M45x2	35	74	29	50
1CA70-35-20	32	1-1/4	-20	31,8	M45x2	35	82	35	50
1CA70-42-24	40	1-1/2	-24	38,1	M52x2	42	99	39	60

Fittings with standard O-ring seals can be used for temperatures from -30 °C up to +105 °C.
Find O-rings in section E. Special O-rings are available on request.
Attention: Hose assembly pressure is reduced; see page Ab-3
Material: steel chromium(VI) free plated

Information about standard products or non-standard products can be found in the current price list.
Dimensions shown may be changed at any time without prior notice.



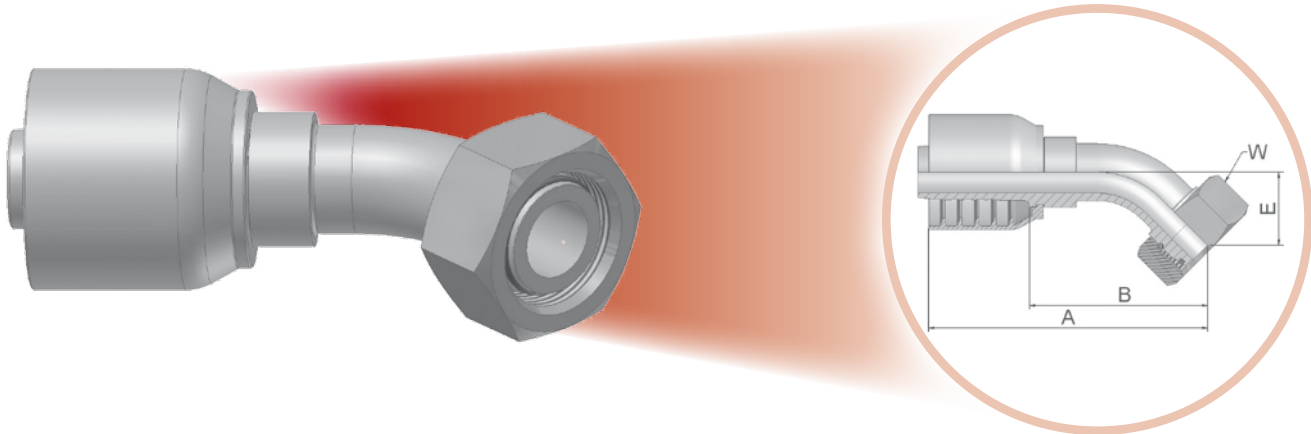

CE – Female Metric 24° – Light Series with O-ring – Swivel – 45° Elbow

ISO 12151-2-SWE45-L – DKOL 45°



Approved fitting series for hose types:



XXXX-XX-XX Part Number 	Hose I.D. 				Thread metric 	Tube O.D. mm	A mm	B mm	E mm	W mm 
	DN	Inch	Size	mm						
1CE70-12-6	10	3/8	-6	9,5	M18x1,5	12	69	40	20	22
1CE70-15-8	12	1/2	-8	12,7	M22x1,5	15	85	50	23	27
1CE70-18-10	16	5/8	-10	15,9	M26x1,5	18	91	52	25	32
1CE70-22-12	20	3/4	-12	19,1	M30x2	22	98	58	26	36
1CE70-28-16	25	1	-16	25,4	M36x2	28	125	80	34	41
1CE70-35-20	32	1-1/4	-20	31,8	M45x2	35	141	94	38	50
1CE70-42-24	40	1-1/2	-24	38,1	M52x2	42	178	118	49	60

Fittings with standard O-ring seals can be used for temperatures from -30 °C up to +105 °C.
Find O-rings in section E. Special O-rings are available on request.
Attention: Hose assembly pressure is reduced; see page Ab-3
Material: steel chromium(VI) free plated

Information about standard products or non-standard products can be found in the current price list.
Dimensions shown may be changed at any time without prior notice.



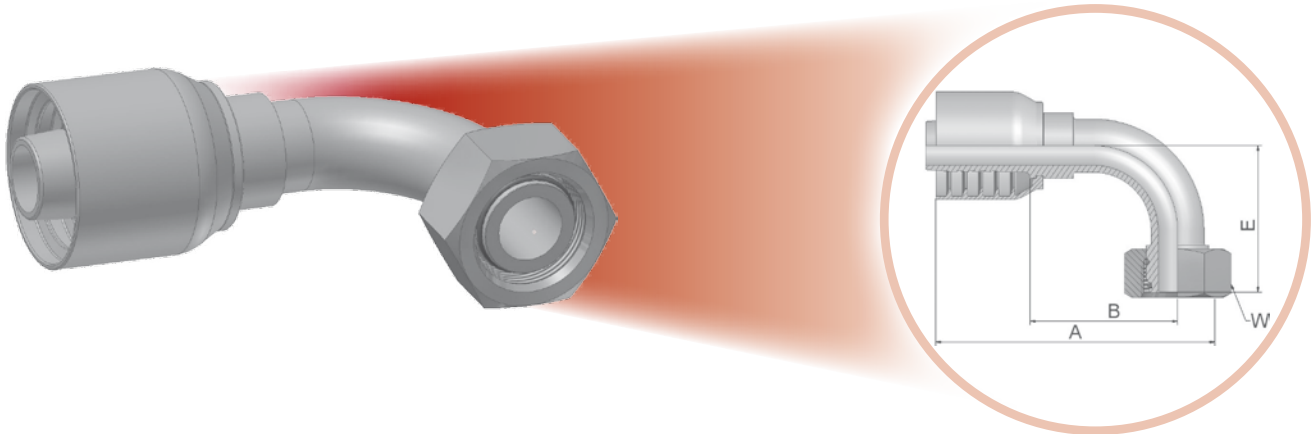

CF – Female Metric 24° – Light Series with O-ring – Swivel – 90° Elbow

ISO 12151-2-SWE-L – DKOL 90°



Approved fitting series for hose types:



XXXX-XX-XX Part Number 	 Hose I.D.				 Thread metric	Tube O.D.	A	B	E	 W
	DN	Inch	Size	mm						
1CF70-12-6	10	3/8	-6	9,5	M18x1,5	12	67	38	37	22
1CF70-15-8	12	1/2	-8	12,7	M22x1,5	15	74	39	45	27
1CF70-15-10	16	5/8	-10	15,9	M22x1,5	15	79	42	50	27
1CF70-18-10	16	5/8	-10	15,9	M26x1,5	18	79	42	49	32
1CF70-18-12	20	3/4	-12	19,1	M26x1,5	18	89	50	56	32
1CF70-22-12	20	3/4	-12	19,1	M30x2	22	89	49	55	36
1CF70-28-16	25	1	-16	25,4	M36x2	28	113	68	73	41
1CF70-35-20	32	1-1/4	-20	31,8	M45x2	35	130	83	79	50
1CF70-42-24	40	1-1/2	-24	38,1	M52x2	42	161	101	101	60

Fittings with standard O-ring seals can be used for temperatures from -30 °C up to +105 °C.

Find O-rings in section E. Special O-rings are available on request.

Attention: Hose assembly pressure is reduced; see page Ab-3

Material: steel chromium(VI) free plated

Information about standard products or non-standard products can be found in the current price list.
Dimensions shown may be changed at any time without prior notice.



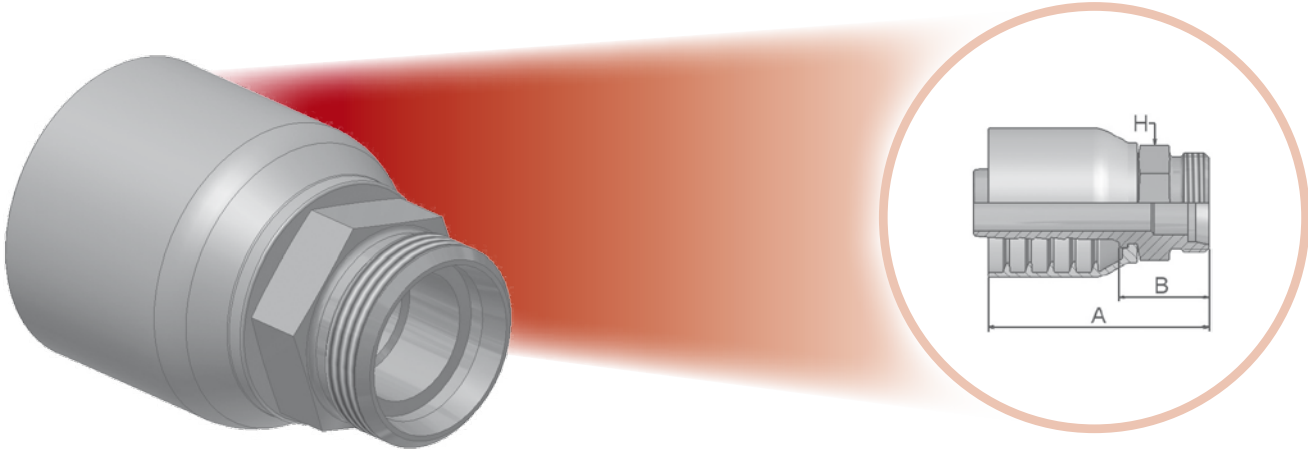

DO – Male Metric 24° – Light Series – Rigid – Straight

ISO 12151-2-S-L – CEL



Approved fitting series for hose types:



XXXX.XX.XX Part Number 	 Hose I.D.				 Thread metric	Tube O.D. mm	A mm	B mm	 H mm
	DN	Inch	Size	mm					
1D070-15-8	12	1/2	-8	12,7	M22x1,5	15	61	26	22
1D070-18-10	16	5/8	-10	15,9	M26x1,5	18	68	28	27
1D070-22-12	20	3/4	-12	19,1	M30x2	22	70	30	30
1D070-28-16	25	1	-16	25,4	M36x2	28	78	33	36

Attention: Hose assembly pressure is reduced; see page Ab-3
Material: steel chromium(VI) free plated

Information about standard products or non-standard products can be found in the current price list.
Dimensions shown may be changed at any time without prior notice.





C9 = Female Metric 24° – Heavy Series with O-ring – Swivel – Straight

ISO 12151-2-SWS-S – DKOS



Approved fitting series for hose types:



XXXX-XX-XX Part Number 	 Hose I.D.				 Thread metric	Tube O.D.	A	B	 W
	DN	Inch	Size	mm					
1C970-8-6	10	3/8	-6	9,5	M16x1,5	8	53	24	19
1C970-12-6	10	3/8	-6	9,5	M20x1,5	12	52	22	24
1C970-14-6	10	3/8	-6	9,5	M22x1,5	14	53	24	27
1C970-12-8	12	1/2	-8	12,7	M20x1,5	12	60	25	24
1C970-16-8	12	1/2	-8	12,7	M24x1,5	16	59	24	30
1C970-16-10	16	5/8	-10	15,9	M24x1,5	16	67	27	30
1C970-20-10	16	5/8	-10	15,9	M30x2	20	64	27	36
1C970-25-10	16	5/8	-10	15,9	M36x2	25	65	29	46
1C970-20-12	20	3/4	-12	19,1	M30x2	20	67	27	36
1C970-25-12	20	3/4	-12	19,1	M36x2	25	68	29	46
1C970-25-16	25	1	-16	25,4	M36x2	25	78	33	46
1C970-30-16	25	1	-16	25,4	M42x2	30	80	33	50
1C970-38-20°	32	1-1/4	-20	31,8	M52x2	38	80	33	60

Fittings with standard O-ring seals can be used for temperatures from -30 °C up to +105 °C.

Find O-rings in section E. Special O-rings are available on request.

° Assembly on Parkrimp® 2 machine only.

Material: steel chromium(VI) free plated

Information about standard products or non-standard products can be found in the current price list.
Dimensions shown may be changed at any time without prior notice.



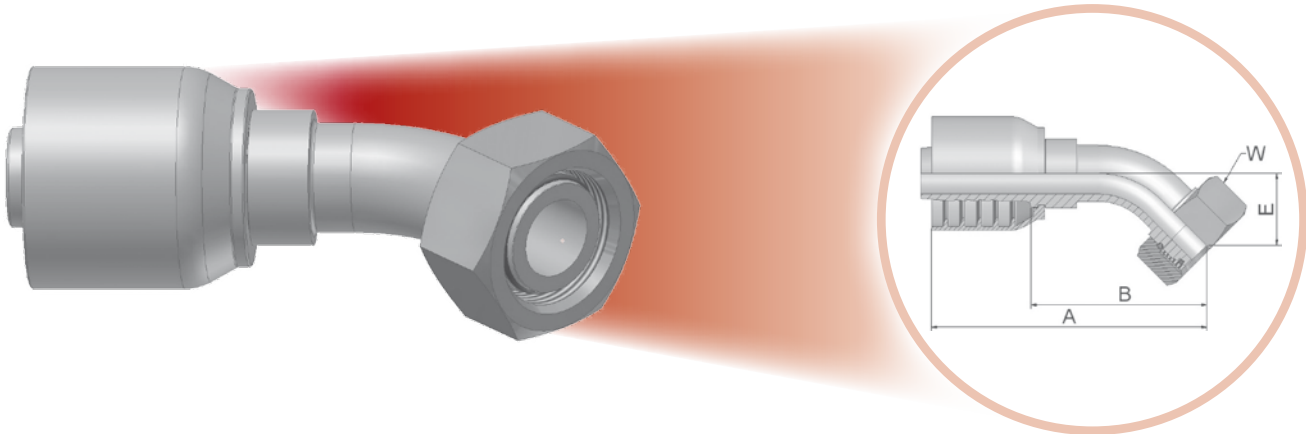

OC – Female Metric 24° – Heavy Series with O-ring – Swivel – 45° Elbow

ISO 12151-2-SWE45-S – DKOS 45°



Approved fitting series for hose types:



XXXX-XX-XX Part Number 	Hose I.D. 				Thread metric 	Tube O.D.	A	B	E	W 
	DN	Inch	Size	mm						
10C70-12-6	10	3/8	-6	9,5	M20x1,5	12	69	40	20	24
10C70-14-6	10	3/8	-6	9,5	M22x1,5	14	76	46	20	27
10C70-16-8	12	1/2	-8	12,7	M24x1,5	16	83	48	24	30
10C70-16-10	16	5/8	-10	15,9	M24x1,5	16	89	49	23	30
10C70-20-10	16	5/8	-10	15,9	M30x2	20	91	52	25	36
10C70-25-10	16	5/8	-10	15,9	M36x2	25	92	56	27	46
10C70-20-12	20	3/4	-12	19,1	M30x2	20	100	60	29	36
10C70-25-12	20	3/4	-12	19,1	M36x2	25	101	61	30	46
10C70-25-16	25	1	-16	25,4	M36x2	25	117	71	32	46
10C70-30-16	25	1	-16	25,4	M42x2	30	124	79	36	50
10C70-38-20°	32	1-1/4	-20	31,8	M52x2	38	142	95	38	60

Fittings with standard O-ring seals can be used for temperatures from -30 °C up to +105 °C.

Find O-rings in section E. Special O-rings are available on request.

° Assembly on Parkrimp® 2 machine only.

Material: steel chromium(VI) free plated

Information about standard products or non-standard products can be found in the current price list.
Dimensions shown may be changed at any time without prior notice.

1C – Female Metric 24° – Heavy Series with O-ring – Swivel – 90° Elbow

ISO 12151-2-SWE-S – DKOS 90°

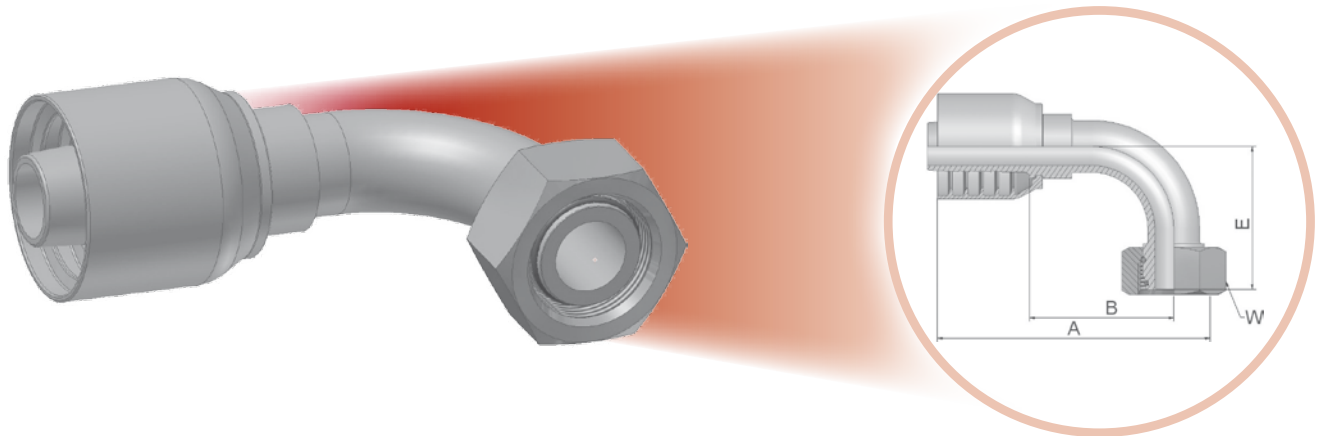

Approved fitting series for hose types:



XXXX-XX-XX Part Number 	Hose I.D.				Thread metric	Tube O.D.	A	B	E	W
	DN	Inch	Size	mm						
11C70-12-6	10	3/8	-6	9,5	M20x1,5	12	67	38	37	24
11C70-14-6	10	3/8	-6	9,5	M22x1,5	14	65	35	37	27
11C70-16-8	12	1/2	-8	12,7	M24x1,5	16	72	37	45	30
11C70-16-10	16	5/8	-10	15,9	M24x1,5	16	79	40	45	30
11C70-20-10	16	5/8	-10	15,9	M30x2	20	79	40	48	36
11C70-25-10	16	5/8	-10	15,9	M36x2	25	85	46	52	46
11C70-25-12	20	3/4	-12	19,1	M36x2	25	89	49	59	46
11C70-25-16	25	1	-16	25,4	M36x2	25	115	68	70	46
11C70-30-16	25	1	-16	25,4	M42x2	30	115	68	76	50
11C70-38-20°	32	1-1/4	-20	31,8	M52x2	38	130	83	80	60

Fittings with standard O-ring seals can be used for temperatures from -30 °C up to +105 °C.

Find O-rings in section E. Special O-rings are available on request.

° Assembly on Parkrimp® 2 machine only.

Material: steel chromium(VI) free plated

Information about standard products or non-standard products can be found in the current price list.
Dimensions shown may be changed at any time without prior notice.



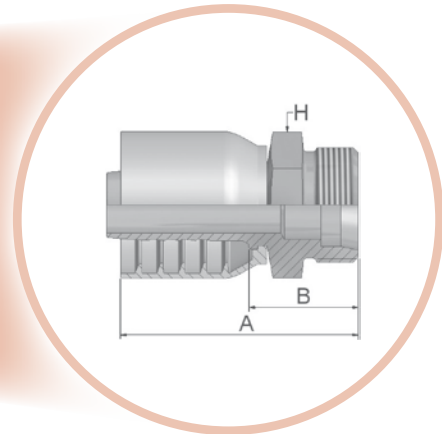
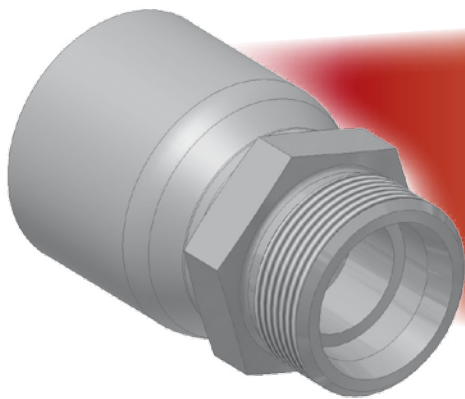

D2 – Male Metric 24° – Heavy Series – Rigid – Straight

ISO 12151-2-S-S – CES



Approved fitting series for hose types:



XXXX-XX-XX Part Number 	 Hose I.D.				 Thread metric	Tube O.D. mm	A mm	B mm	 H mm
	DN	Inch	Size	mm					
1D270-12-6	10	3/8	-6	9,5	M20x1,5	12	53	24	22
1D270-14-6	10	3/8	-6	9,5	M22x1,5	14	55	25	22
1D270-16-8	12	1/2	-8	12,7	M24x1,5	16	62	28	24
1D270-20-8	12	1/2	-8	12,7	M30x2	20	67	32	30
1D270-20-10	16	5/8	-10	15,9	M30x2	20	75	32	30
1D270-20-12	20	3/4	-12	19,1	M30x2	20	72	33	30
1D270-25-12	20	3/4	-12	19,1	M36x2	25	73	33	36
1D270-25-16	25	1	-16	25,4	M36x2	25	82	37	36
1D270-30-16	25	1	-16	25,4	M42x2	30	85	40	46
1D270-38-20	32	1-1/4	-20	31,8	M52x2	38	91	44	55

Material: steel chromium(VI) free plated

Information about standard products or non-standard products can be found in the current price list. Dimensions shown may be changed at any time without prior notice.



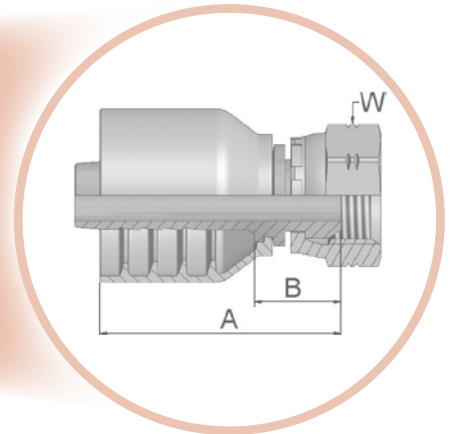
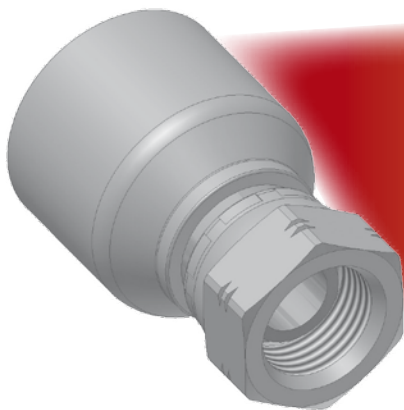

92 = Female BSP Parallel Pipe – Swivel – Straight (60° Cone)

BS5200-A – DKR



Approved fitting series for hose types:



XXXX-XX-XX Part Number 	Hose I.D. 				Thread BSP 	A mm	B mm	W mm 
	DN	Inch	Size	mm				
19270-6-6	10	3/8	-6	9,5	3/8x19	49	20	22
19270-8-6	10	3/8	-6	9,5	1/2x14	51	22	27
19270-8-8	12	1/2	-8	12,7	1/2x14	57	22	27
19270-10-8	12	1/2	-8	12,7	5/8x14	55	20	30
19270-10-10	16	5/8	-10	15,9	5/8x14	57	21	30
19270-12-10	16	5/8	-10	15,9	3/4x14	61	22	32
19270-12-12	20	3/4	-12	19,1	3/4x14	64	24	32
19270-16-12	20	3/4	-12	19,1	1x11	63	24	41
19270-16-16	25	1	-16	25,4	1x11	76	27	41
19270-20-20	32	1-1/4	-20	31,8	1-1/4x11	79	32	50
19270-24-24	40	1-1/2	-24	38,1	1-1/2x11	94	33	60

Material: steel chromium(VI) free plated

Information about standard products or non-standard products can be found in the current price list.
Dimensions shown may be changed at any time without prior notice.



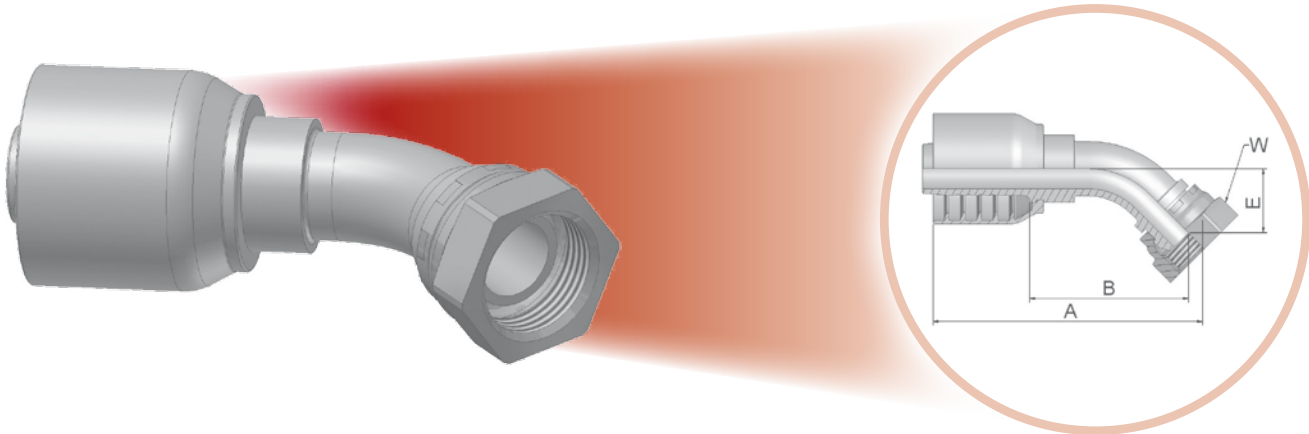

B1 - Female BSP Parallel Pipe - Swivel - 45° Elbow (60° Cone)

BS 5200-D - DKR 45°



Approved fitting series for hose types:



XXXX-XX-XX Part Number 	 Hose I.D.				 Thread BSP	A	B	E	 W
	DN	Inch	Size	mm					
1B170-6-6	10	3/8	-6	9,5	3/8x19	67	37	17	22
1B170-8-8	12	1/2	-8	12,7	1/2x14	79	45	20	27
1B170-10-8	12	1/2	-8	12,7	5/8x14	78	43	19	30
1B170-10-10	16	5/8	-10	15,9	5/8x14	90	50	24	30
1B170-12-10	16	5/8	-10	15,9	3/4x14	88	49	22	32
1B170-12-12	20	3/4	-12	19,1	3/4x14	96	57	25	32
1B170-16-16	25	1	-16	25,4	1x11	120	75	31	41
1B170-20-20	32	1-1/4	-20	31,8	1-1/4x11	139	91	35	50
1B170-24-24	40	1-1/2	-24	38,1	1-1/2x11	169	108	38	55

Material: steel chromium(VI) free plated

Information about standard products or non-standard products can be found in the current price list. Dimensions shown may be changed at any time without prior notice.



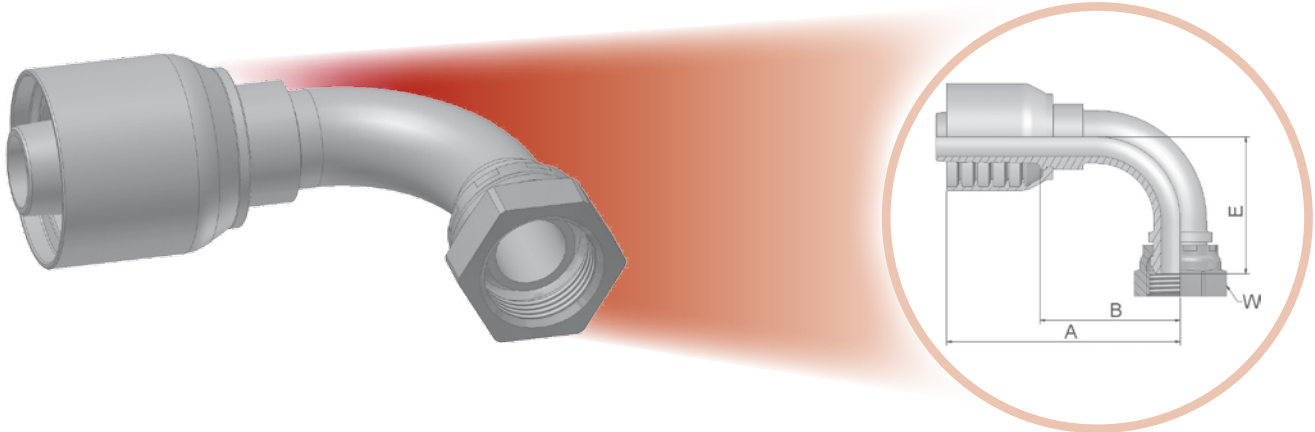

B2 – Female BSP Parallel Pipe – Swivel – 90° Elbow (60° Cone)

BS 5200-B – DKR 90°



Approved fitting series for hose types:



XXXX-XX-XX Part Number 	 Hose I.D.				 Thread BSP	A	B	E	 W
	DN	Inch	Size	mm					
1B270-6-6	10	3/8	-6	9,5	3/8x19	66	37	33	22
1B270-8-6	10	3/8	-6	9,5	1/2x14	66	37	35	27
1B270-8-8	12	1/2	-8	12,7	1/2x14	70	35	39	27
1B270-10-8	12	1/2	-8	12,7	5/8x14	74	39	38	30
1B270-10-10	16	5/8	-10	15,9	5/8x14	78	41	46	30
1B270-12-10	16	5/8	-10	15,9	3/4x14	81	41	42	32
1B270-12-12	20	3/4	-12	19,1	3/4x14	89	50	53	32
1B270-16-12	20	3/4	-12	19,1	1x11	89	49	51	41
1B270-16-16	25	1	-16	25,4	1x11	116	69	69	41
1B270-20-20	32	1-1/4	-20	31,8	1-1/4x11	130	82	76	50
1B270-24-24	40	1-1/2	-24	38,1	1-1/2x11	158	102	86	55

Material: steel chromium(VI) free plated

Information about standard products or non-standard products can be found in the current price list.
Dimensions shown may be changed at any time without prior notice.





EA – BSP Swivel Female with O-ring (60° Cone)

BS 5200 – ISO 12151-6 – DKOR



Approved fitting series for hose types:



XXXX-XX-XX Part Number 	 Hose I.D.				 Thread BSP	A mm	B mm	 W mm
	DN	Inch	Size	mm				
1EA70-8-8	12	1/2	-8	12,7	1/2x14	56	21	27
1EA70-12-12	20	3/4	-12	19,1	3/4x14	63	23	32
1EA70-16-16	25	1	-16	25,4	1x11	76	31	41
1EA70-20-20	32	1-1/4	-20	31,8	1-1/4x11	78	31	50

Fittings with standard O-ring seals can be used for temperatures from -30 °C up to +105 °C.
 Find O-rings in section E. Special O-rings are available on request.
 Material: steel chromium(VI) free plated

Information about standard products or non-standard products can be found in the current price list.
 Dimensions shown may be changed at any time without prior notice.



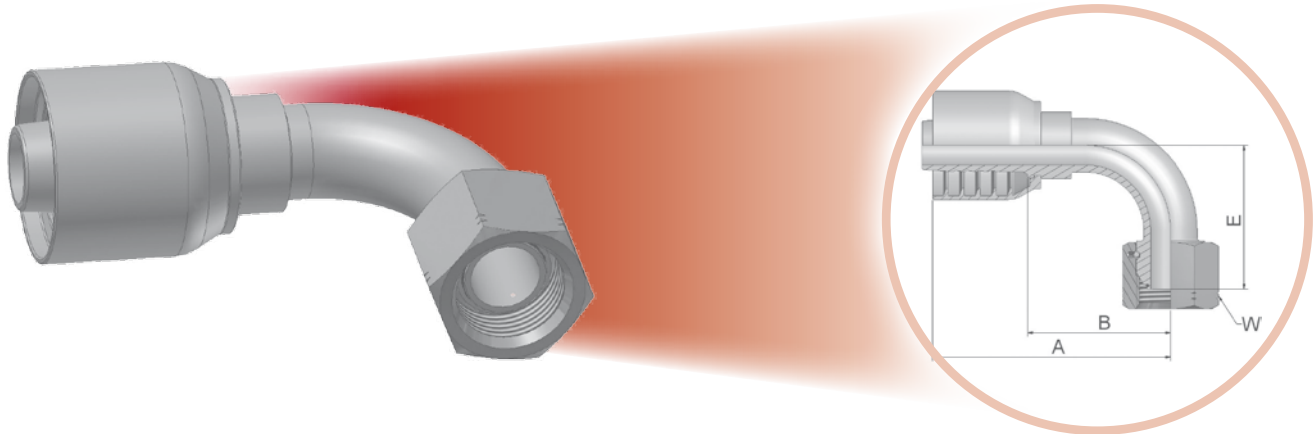

EC – BSP Swivel Female with O-ring – 90° Elbow (60° Cone)

BS 5200 – ISO 12151-6 – DKOR 90°



Approved fitting series for hose types:



XXXX-XX-XX Part Number 	Hose I.D. 				Thread BSP 	A	B	E	W 
	DN	Inch	Size	mm					
1EC70-8-8	12	1/2	-8	12,7	1/2x14	71	36	40	27
1EC70-12-12	20	3/4	-12	19,1	3/4x14	89	50	55	32
1EC70-16-16	25	1	-16	25,4	1x11	115	68	71	41
1EC70-20-20	32	1.1/4	-20	31,8	1-1/4x11	130	82	76	50

Fittings with standard O-ring seals can be used for temperatures from -30 °C up to +105 °C.
Find O-rings in section E. Special O-rings are available on request.
Material: steel chromium(VI) free plated

Information about standard products or non-standard products can be found in the current price list.
Dimensions shown may be changed at any time without prior notice.





D9 – Male BSP Parallel Pipe – Rigid – Straight (60° Cone)

BS5200 – AGR



Approved fitting series for hose types:



XXXX-XX-XX Part Number 	Hose I.D. 				Thread BSP 	A mm	B mm	H mm 
	DN	Inch	Size	mm				
1D970-6-6	10	3/8	-6	9,5	3/8x19	57	28	22
1D970-8-6	10	3/8	-6	9,5	1/2x14	60	31	27
1D970-8-8	12	1/2	-8	12,7	1/2x14	62	28	27
1D970-12-8	12	1/2	-8	12,7	3/4x14	69	35	32
1D970-10-10	16	5/8	-10	15,9	5/8x14	75	35	30
1D970-12-10	16	5/8	-10	15,9	3/4x14	72	35	32
1D970-12-12	20	3/4	-12	19,1	3/4x14	70	30	32
1D970-16-12	20	3/4	-12	19,1	1x11	77	38	41
1D970-16-16	25	1	-16	25,4	1x11	82	35	41
1D970-20-20	32	1-1/4	-20	31,8	1-1/4x11	92	45	50
1D970-24-24	40	1-1/2	-24	38,1	1-1/2x11	109	49	55

Material: steel chromium(VI) free plated

Information about standard products or non-standard products can be found in the current price list.
Dimensions shown may be changed at any time without prior notice.



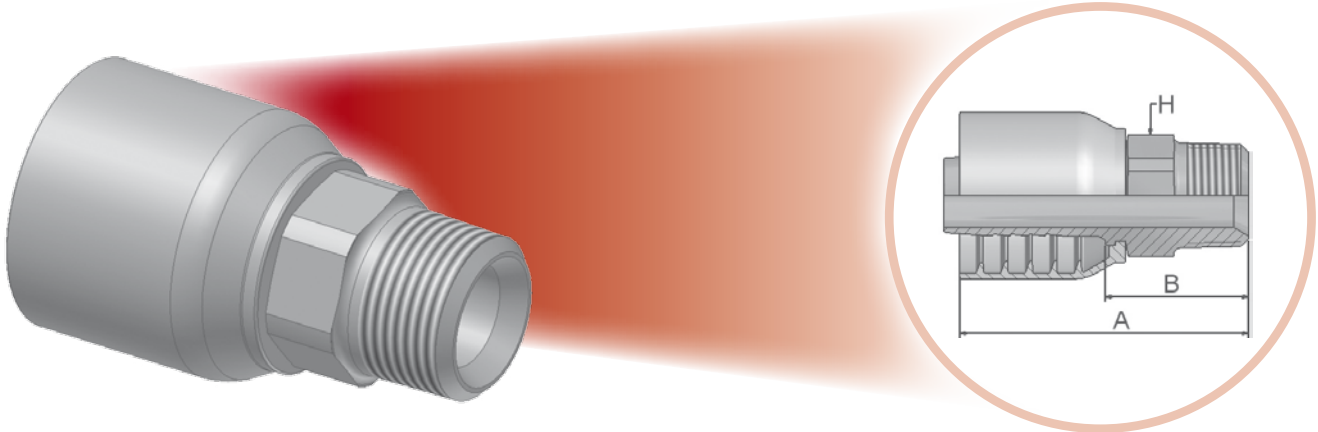

01 - Male NPTF Pipe - Rigid - Straight

SAE J476A - J516 - AGN



Approved fitting series for hose types:



XXXX-XX-XX Part Number 	 Hose I.D.				 Thread NPTF	A mm	B mm	 H mm
	DN	Inch	Size	mm				
10170-6-6-SM	10	3/8	-6	9,5	3/8x18	60	31	19
10170-8-6-SM	10	3/8	-6	9,5	1/2x14	61	32	22
10170-8-8-SM	12	1/2	-8	12,7	1/2x14	72	37	22
10170-12-8-SM	12	1/2	-8	12,7	3/4x14	68	33	27
10170-8-10-SM	16	5/8	-10	15,9	1/2x14	75	38	24
10170-12-10-SM	16	5/8	-10	15,9	3/4x14	71	34	27
10170-12-12-SM	20	3/4	-12	19,1	3/4x14	79	39	32
10170-16-12-SM	20	3/4	-12	19,1	1x11-1/2	79	39	36
10170-16-16-SM	25	1	-16	25,4	1x11-1/2	91	46	36
10170-20-20-SM	32	1-1/4	-20	31,8	1-1/4x11-1/2	104	57	46
10170-24-24-SM	40	1.1/2	-24	38,1	1-1/2x11-1/2	112	51	50

Material: steel chromium(VI) free plated
SM: Metric Hexagon

Information about standard products or non-standard products can be found in the current price list.
Dimensions shown may be changed at any time without prior notice.



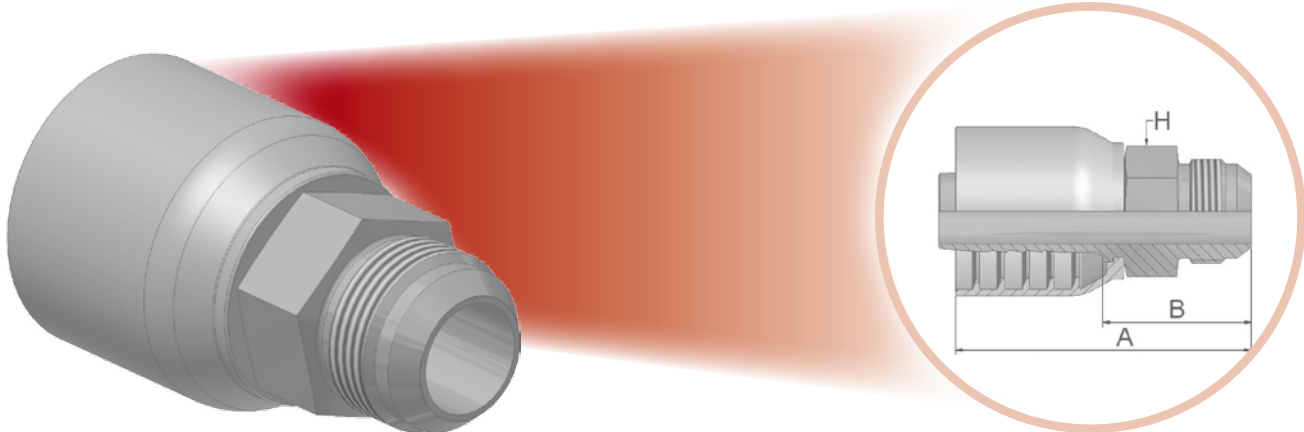

03 - Male JIC 37° - Rigid - Straight

ISO12151-5-S – AGJ



Approved fitting series for hose types:



XXXX-XX-XX Part Number 	 Hose I.D.				 Thread UNF	A mm	B mm	 H mm
	DN	Inch	Size	mm				
10370-6-6-SM	10	3/8	-6	9,5	9/16x18	60	31	19
10370-8-6-SM	10	3/8	-6	9,5	3/4x16	59	29	19
10370-8-8-SM	12	1/2	-8	12,7	3/4x16	68	33	22
10370-10-8-SM	12	1/2	-8	12,7	7/8x14	67	32	24
10370-12-8-SM	12	1/2	-8	12,7	1-1/16x12	71	36	27
10370-10-10-SM	16	5/8	-10	15,9	7/8x14	75	38	24
10370-12-10-SM	16	5/8	-10	15,9	1-1/16x12	75	36	27
10370-12-12-SM	20	3/4	-12	19,1	1-1/16x12	81	42	27
10370-16-12-SM	20	3/4	-12	19,1	1-5/16x12	78	38	36
10370-16-16-SM	25	1	-16	25,4	1-5/16x12	92	47	36
10370-20-16-SM	25	1	-16	25,4	1-5/8x12	88	43	46
10370-20-20-SM	32	1-1/4	-20	31,8	1-5/8x12	101	53	46
10370-24-24-SM	40	1-1/2	-24	38,1	1-7/8x12	110	49	50

Material: steel chromium(VI)
free plated
SM: Metric Hexagon

Information about standard products or non-standard products can be found in the current price list.
Dimensions shown may be changed at any time without prior notice.



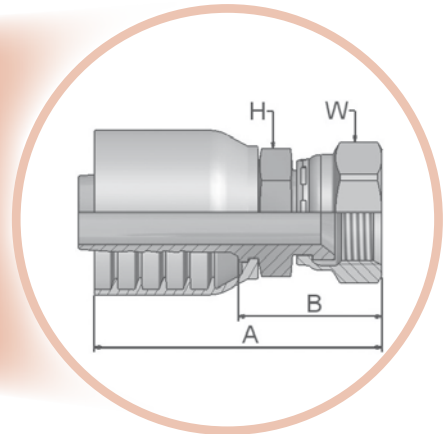
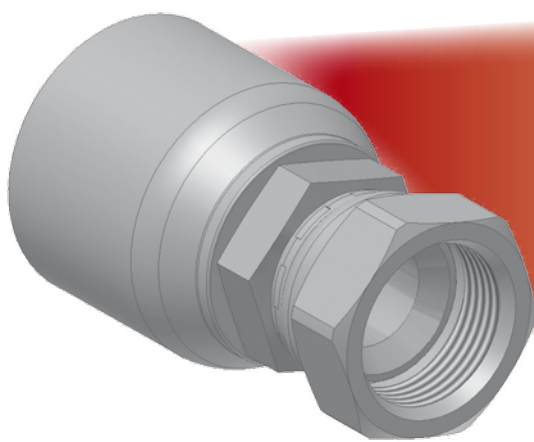

06/68 – Female – JIC 37° / SAE 45° Dual Flare – Swivel – Straight

ISO12151-5-SWS – DKJ



Approved fitting series for hose types:



XXXX-XX-XX Part Number 	 Hose I.D.				 Thread UNF	A	B	E	 W
	DN	Inch	Size	mm					
10670-6-6-SM	10	3/8	-6	9,5	9/16x18	58	29	17	19
10670-8-6-SM*	10	3/8	-6	9,5	3/4x16	61	32	19	22
10670-10-6-SM*	10	3/8	-6	9,5	7/8x14	51	22	22	27
10670-8-8-SM*	12	1/2	-8	12,7	3/4x16	56	21	22	22
10670-10-8-SM*	12	1/2	-8	12,7	7/8x14	70	35	22	27
10670-12-8-SM	12	1/2	-8	12,7	1-1/16x12	56	21	27	32
10670-8-10-SM*	16	5/8	-10	15,9	3/4x16	73	36	24	22
16870-10-10-SM*	16	5/8	-10	15,9	7/8x14	75	35	24	27
10670-12-10-SM	16	5/8	-10	15,9	1-1/16x12	78	41	27	32
10670-12-12-SM	20	3/4	-12	19,1	1-1/16x12	80	41	27	32
10670-14-12-SM	20	3/4	-12	19,1	1-3/16x12	81	42	32	36
10670-16-12-SM	20	3/4	-12	19,1	1-5/16x12	84	45	32	41
10670-12-16-SM	25	1	-16	25,4	1-1/16x12	89	44	36	32
10670-16-16-SM	25	1	-16	25,4	1-5/16x12	92	47	36	41
10670-20-16-SM	25	1	-16	25,4	1-5/8x12	81	36	41	50
10670-16-20-SM	32	1-1/4	-20	31,8	1-5/16x12	97	50	46	41
10670-20-20-SM	32	1-1/4	-20	31,8	1-5/8x12	83	37	46	50
10670-24-24-SM	40	1-1/2	-24	38,1	1-7/8x12	101	41	50	60

* These fittings contain a dual seat that accepts both JIC (37°) and SAE (45°) male configurations. The other sizes accept the JIC (37°) male configurations only.

Material: steel chromium(VI) free plated
SM: Metric Hexagon

Information about standard products or non-standard products can be found in the current price list.
Dimensions shown may be changed at any time without prior notice.



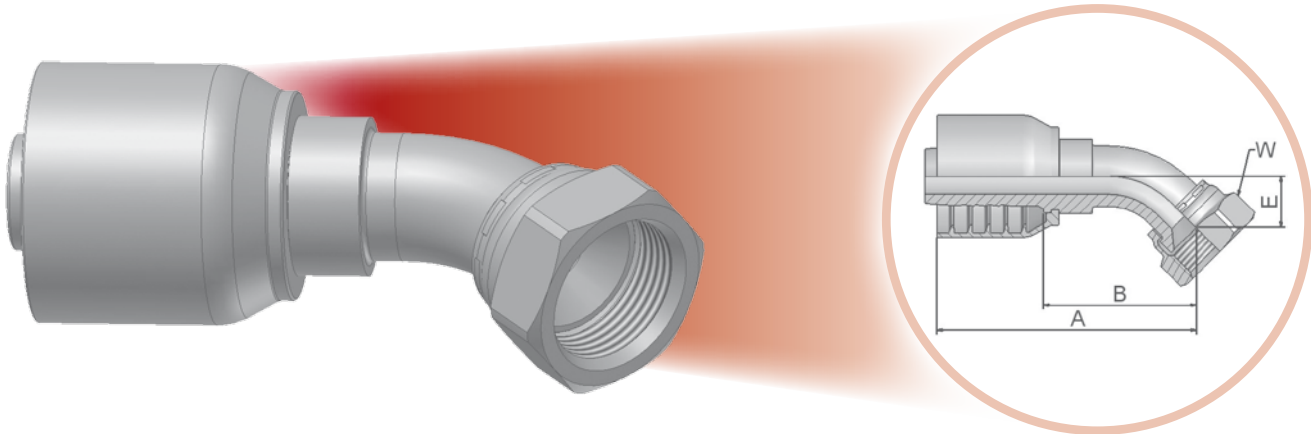

37/3V – Female JIC 37° /SAE 45° – Dual Flare – Swivel Female 45° Elbow

ISO 12151-5-SWE45 – DKJ 45°



Approved fitting series for hose types:



XXXX-XX-XX Part Number 	 Hose I.D.				 Thread UNF	A	B	E	 W
	DN	Inch	Size	mm					
13770-8-6-SM*	10	3/8	-6	9,5	3/4x16	70	41	14	22
13770-8-8-SM*	12	1/2	-8	12,7	3/4x16	73	38	14	22
13770-10-8-SM*	12	1/2	-8	12,7	7/8x14	78	43	17	27
13770-8-10-SM*	16	5/8	-10	15,9	3/4x16	78	39	15	22
13770-10-10-SM*	16	5/8	-10	15,9	7/8x14	83	44	17	27
13770-12-10-SM	16	5/8	-10	15,9	1-1/16x12	85	48	21	32
13770-12-12-SM	20	3/4	-12	19,1	1-1/16x12	91	52	20	32
13770-16-12-SM	20	3/4	-12	19,1	1-5/16x12	95	56	24	41
13770-16-16-SM	25	1	-16	25,4	1-5/16x12	111	66	24	41
13770-20-16-SM	25	1	-16	25,4	1-5/8x12	113	67	26	50
13770-20-20-SM	32	1-1/4	-20	31,8	1-5/8x12	134	87	31	50
13770-24-24-SM	40	1.1/2	-24	38,1	1-7/8x12	174	114	46	60

* These fittings contain a dual seat that accepts both JIC (37°) and SAE (45°) male configurations. The other sizes accept the JIC (37°) male configurations only.
Material: steel chromium(VI) free plated
SM: Metric Hexagon

Information about standard products or non-standard products can be found in the current price list. Dimensions shown may be changed at any time without prior notice.



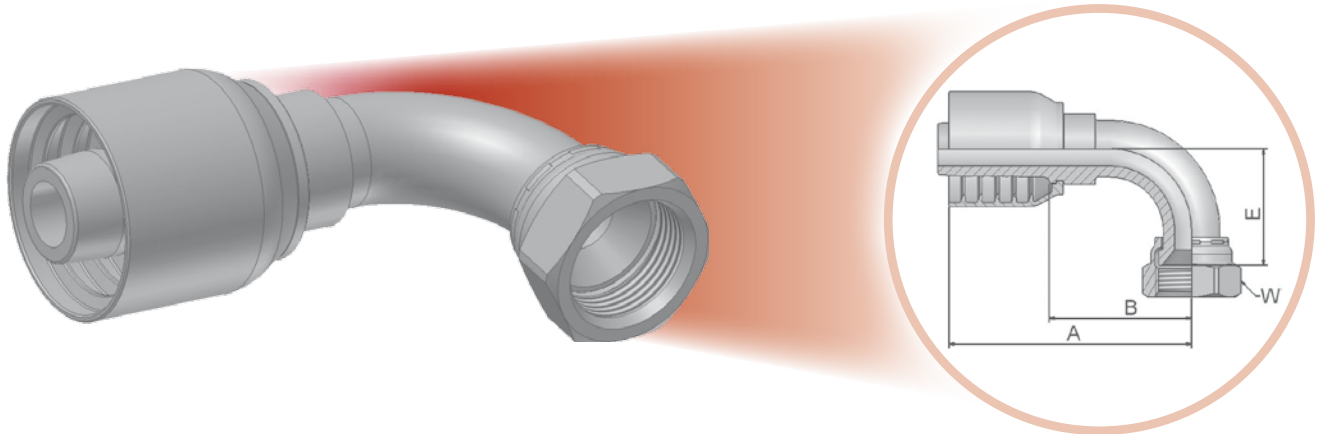

39/3W – Female JIC 37° / SAE 45° – Dual Flare – Swivel Female 90° Elbow

ISO 12151-5-SWES – DKJ 90°



Approved fitting series for hose types:



XXXX-XX-XX Part Number 	 Hose I.D.				 Thread UNF	A	B	E	 W
	DN	Inch	Size	mm					
13970-6-6-SM	10	3/8	-6	9,5	9/16x18	58	29	22	19
13W70-8-6-SM*	10	3/8	-6	9,5	3/4x16	64	35	28	22
13970-6-8-SM	12	1/2	-8	12,7	9/16x18	64	29	22	19
13970-8-8-SM*	12	1/2	-8	12,7	3/4x16	68	33	28	22
13970-10-8-SM*	12	1/2	-8	12,7	7/8x14	74	39	32	27
13970-12-8-SM	12	1/2	-8	12,7	1-1/16x12	83	48	47	32
13970-8-10-SM*	16	5/8	-10	15,9	3/4x16	74	34	28	22
13970-10-10-SM*	16	5/8	-10	15,9	7/8x14	80	41	33	27
13970-12-10-SM	16	5/8	-10	15,9	1-1/16x12	86	48	47	32
13970-12-12-SM	20	3/4	-12	19,1	1-1/16x12	89	50	48	32
13970-16-12-SM	20	3/4	-12	19,1	1-5/16x12	89	50	51	41
13970-12-16-SM	25	1	-16	25,4	1-1/16x12	101	54	46	32
13970-16-16-SM	25	1	-16	25,4	1-5/16x12	111	64	55	41
13970-20-16-SM	25	1	-16	25,4	1-5/8x12	109	64	62	50
13970-20-20-SM	32	1-1/4	-20	31,8	1-5/8x12	130	83	70	50
13970-24-20-SM	32	1-1/4	-20	31,8	1-7/8x12	130	82	80	60
13970-24-24-SM	40	1-1/2	-24	38,1	1-7/8x12	156	101	101	60

* These fittings contain a dual seat that accepts both JIC (37°) and SAE (45°) male configurations. The other sizes accept the JIC (37°) male configurations only.

Material: steel chromium(VI) free plated
SM: Metric Hexagon

Information about standard products or non-standard products can be found in the current price list.
Dimensions shown may be changed at any time without prior notice.

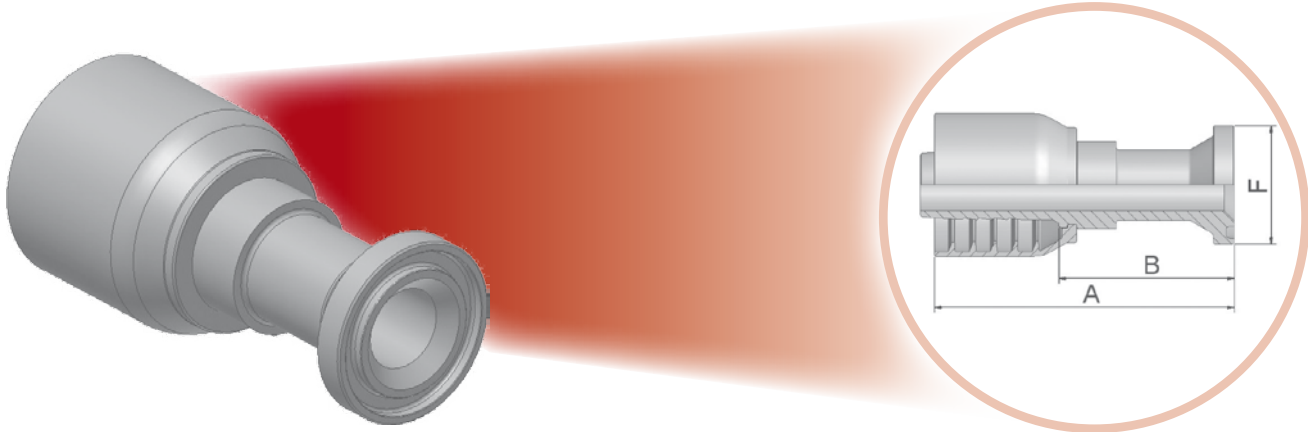

15 – SAE Code 61 – Flange Head – Straight

ISO 12151-3-S-L – SFL – 3000 psi



Approved fitting series for hose types:



XXXX-XX-XX Part Number 	 Hose I.D.				 End connection	A	B	F
	DN	Inch	Size	mm				
11570-8-8	12	1/2	-8	12,7	1/2	89	54	30
11570-10-10	16	5/8	-10	15,9	5/8	116	79	34
11570-12-10	16	5/8	-10	15,9	3/4	69	30	38
11570-12-12	20	3/4	-12	19,1	3/4	98	59	38
11570-16-12	20	3/4	-12	19,1	1	70	31	45
11570-20-12	20	3/4	-12	19,1	1-1/4	75	36	51
11570-16-16	25	1	-16	25,4	1	108	63	45
11570-20-16	25	1	-16	25,4	1-1/4	82	36	51
11570-16-20	32	1-1/4	-20	31,8	1	120	72	45
11570-20-20	32	1-1/4	-20	31,8	1-1/4	120	72	51
11570-24-20	32	1-1/4	-20	31,8	1-1/2	82	35	60
11570-24-24	40	1-1/2	-24	38,1	1-1/2	140	80	60

Find SAE flange halves in section Eb.
 Fittings with standard O-ring seals can be used for temperatures from -30 °C up to +105 °C.
 Find O-rings in section E. Special O-rings are available on request.
 Material: steel chromium(VI) free plated

Information about standard products or non-standard products can be found in the current price list.
 Dimensions shown may be changed at any time without prior notice.

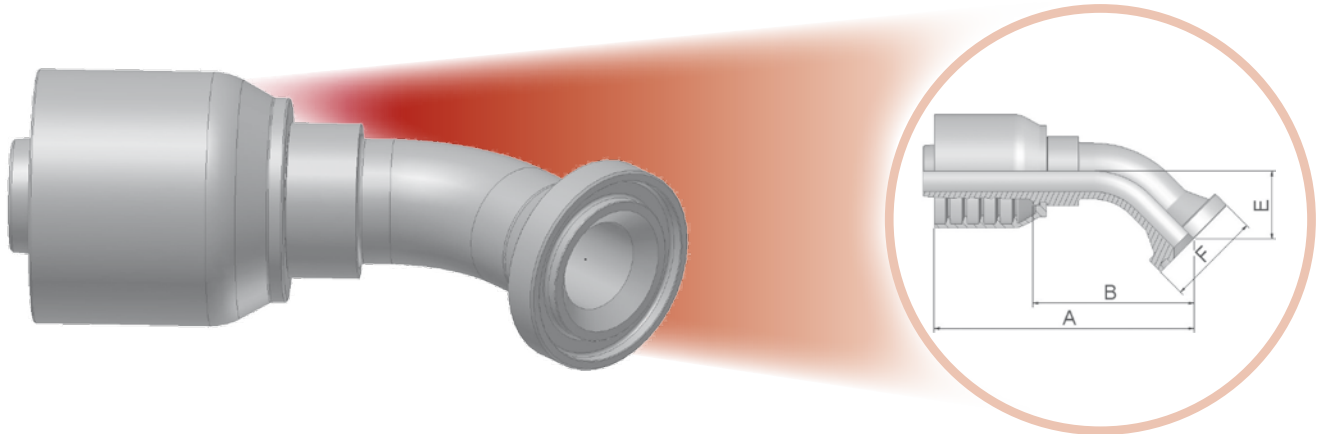

17 - SAE Code 61 - Flange Head - 45° Elbow

ISO 12151-3-E45-L - SFL 45° - 3000 psi



Approved fitting series for hose types:



XXXX-XX-XX Part Number 	 Hose I.D.				 End connection	A	B	E	F
	DN	Inch	Size	mm					
11770-8-8	12	1/2	-8	12,7	1/2	79	44	20	30
11770-10-10	16	5/8	-10	15,9	5/8	104	67	24	34
11770-12-10	16	5/8	-10	15,9	3/4	96	57	26	38
11770-12-12	20	3/4	-12	19,1	3/4	98	58	26	38
11770-16-12	20	3/4	-12	19,1	1	97	57	25	45
11770-16-16	25	1	-16	25,4	1	119	74	32	45
11770-20-16	25	1	-16	25,4	1-1/4	121	76	32	51
11770-20-20	32	1-1/4	-20	31,8	1-1/4	132	85	29	51
11770-24-20	32	1-1/4	-20	31,8	1-1/2	141	94	38	60
11770-24-24	40	1-1/2	-24	38,1	1-1/2	166	106	37	60
11770-32-24	40	1-1/2	-24	38,1	2	165	105	37	71

Find SAE flange halves in section Eb.
 Fittings with standard O-ring seals can be used for temperatures from -30 °C up to +105 °C.
 Find O-rings in section E. Special O-rings are available on request.
 Material: steel chromium(VI) free plated

Information about standard products or non-standard products can be found in the current price list.
 Dimensions shown may be changed at any time without prior notice.

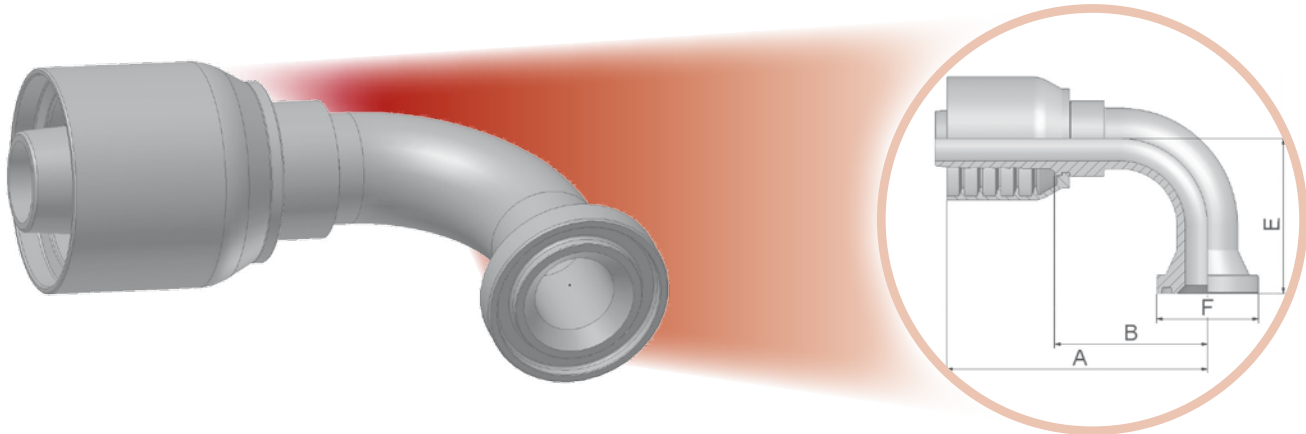

19 – SAE Code 61 – Flange Head – 90° Elbow

ISO 12151-3-E-L – SFL 90° – 3000 psi



Approved fitting series for hose types:



XXXX-XX-XX Part Number 	 Hose I.D.				 End connection	A	B	E	F
	DN	Inch	Size	mm		mm	mm	mm	mm
11970-8-8	12	1/2	-8	12,7	1/2	75	40	41	30
11970-12-8	12	1/2	-8	12,7	3/4	77	42	42	38
11970-8-10	16	5/8	-10	15,9	1/2	92	56	54	30
11970-10-10	16	5/8	-10	15,9	5/8	92	55	55	34
11970-12-10	16	5/8	-10	15,9	3/4	92	55	54	38
11970-12-12	20	3/4	-12	19,1	3/4	89	50	58	38
11970-16-12	20	3/4	-12	19,1	1	90	50	58	45
11970-20-12	20	3/4	-12	19,1	1-1/4	90	50	70	51
11970-16-16	25	1	-16	25,4	1	111	64	70	45
11970-20-16	25	1	-16	25,4	1-1/4	113	68	70	51
11970-16-20	32	1-1/4	-20	31,8	1	130	82	90	45
11970-20-20	32	1-1/4	-20	31,8	1-1/4	130	82	90	51
11970-24-20	32	1-1/4	-20	31,8	1-1/2	130	83	67	60
11970-24-24	40	1-1/2	-24	38,1	1-1/2	161	101	79	60
11970-32-24	40	1-1/2	-24	38,1	2	161	101	80	71

Find SAE flange halves in section Eb.

Fittings with standard O-ring seals can be used for temperatures from -30 °C up to +105 °C.

Find O-rings in section E. Special O-rings are available on request.

Material: steel chromium(VI) free plated

Information about standard products or non-standard products can be found in the current price list.
Dimensions shown may be changed at any time without prior notice.

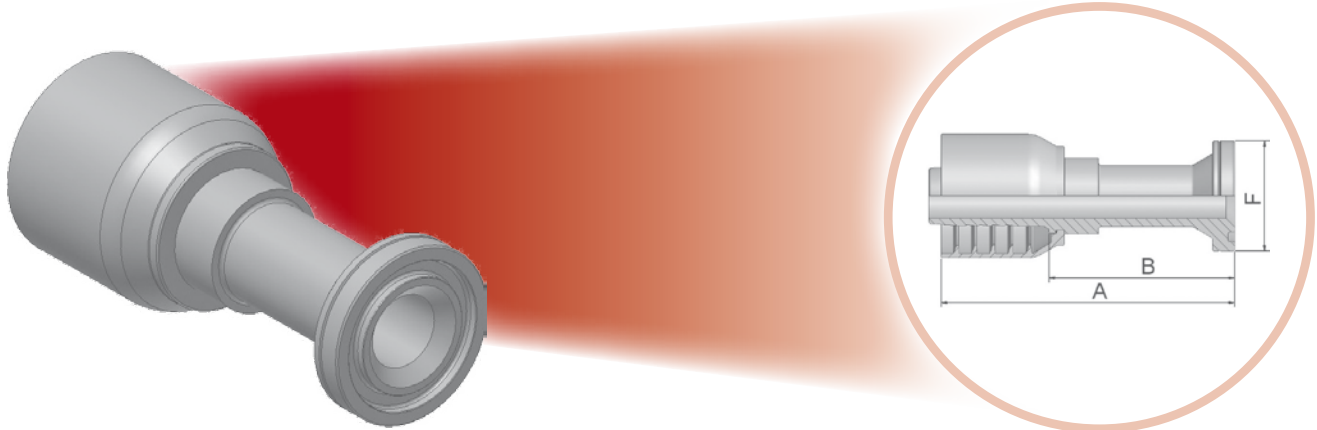

6A – SAE Code 62 – Flange – Straight

ISO 12151-3-S-S – SFS – 6000 psi



Approved fitting series for hose types:



XXXX-XX-XX Part Number 	 Hose I.D.				 End connection	A	B	F
	DN	Inch	Size	mm		mm	mm	mm
16A70-8-8	12	1/2	-8	12,7	1/2	103	68	32
16A70-8-10	16	5/8	-10	15,9	1/2	107	68	32
16A70-12-10	16	5/8	-10	15,9	3/4	117	78	41
16A70-8-12	20	3/4	-12	19,1	1/2	107	67	32
16A70-12-12	20	3/4	-12	19,1	3/4	105	66	41
16A70-16-12	20	3/4	-12	19,1	1	110	70	48
16A70-12-16	25	1	-16	25,4	3/4	127	82	41
16A70-16-16	25	1	-16	25,4	1	127	82	48
16A70-20-16	25	1	-16	25,4	1-1/4	127	82	54
16A70-20-20	32	1-1/4	-20	31,8	1-1/4	130	83	54
16A70-24-20	32	1-1/4	-20	31,8	1-1/2	131	84	64
16A70-24-24	40	1-1/2	-24	38,1	1-1/2	163	103	64

Find SAE flange halves in section Eb.
 Fittings with standard O-ring seals can be used for temperatures from -30 °C up to +105 °C.
 Find O-rings in section E. Special O-rings are available on request.
 Material: steel chromium(VI) free plated

Information about standard products or non-standard products can be found in the current price list.
 Dimensions shown may be changed at any time without prior notice.

6F – SAE Flange 45° Elbow – Heavy Series

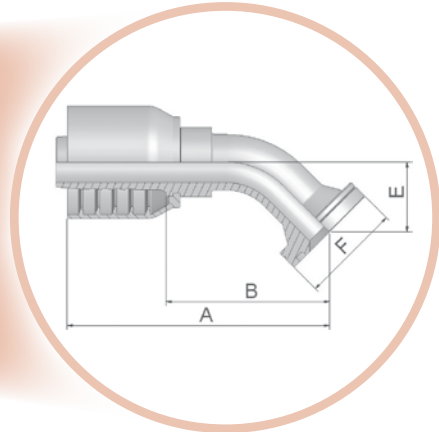
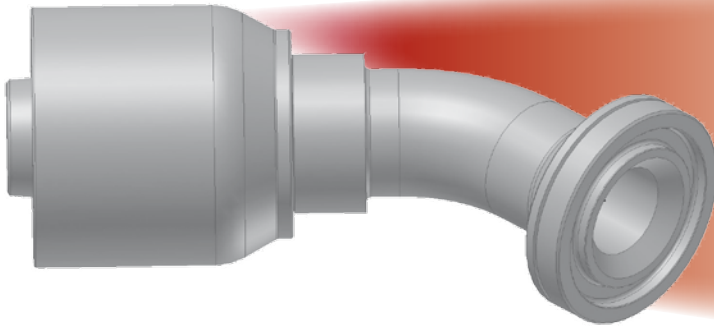

ISO 12151-3-E45-S – SFS 45° – 6000 psi



Approved fitting series for hose types:



371LT/372/372RH/372TC/701

XXXX·XX·XX Part Number 	 Hose I.D.				 End connection	A	B	E	F
	DN	Inch	Size	mm					
16F70-8-8	12	1/2	-8	12,7	1/2	81	46	19	32
16F70-8-10	16	5/8	-10	15,9	1/2	92	53	26	32
16F70-12-10	16	5/8	-10	15,9	3/4	92	55	26	41
16F70-8-12	20	3/4	-12	19,1	1/2	94	54	26	32
16F70-12-12	20	3/4	-12	19,1	3/4	105	66	26	41
16F70-16-12	20	3/4	-12	19,1	1	101	62	26	48
16F70-12-16	25	1	-16	25,4	3/4	118	73	27	41
16F70-16-16	25	1	-16	25,4	1	121	74	32	48
16F70-20-16	25	1	-16	25,4	1-1/4	117	70	31	54
16F70-20-20	32	1-1/4	-20	31,8	1-1/4	141	94	38	54
16F70-24-20	32	1-1/4	-20	31,8	1-1/2	141	94	38	64
16F70-24-24	40	1-1/2	-24	38,1	1-1/2	173	113	44	64

Find SAE flange halves in section Eb.

Fittings with standard O-ring seals can be used for temperatures from -30 °C up to +105 °C.

Find O-rings in section E. Special O-rings are available on request.

Material: steel chromium(VI) free plated

Information about standard products or non-standard products can be found in the current price list.
Dimensions shown may be changed at any time without prior notice.

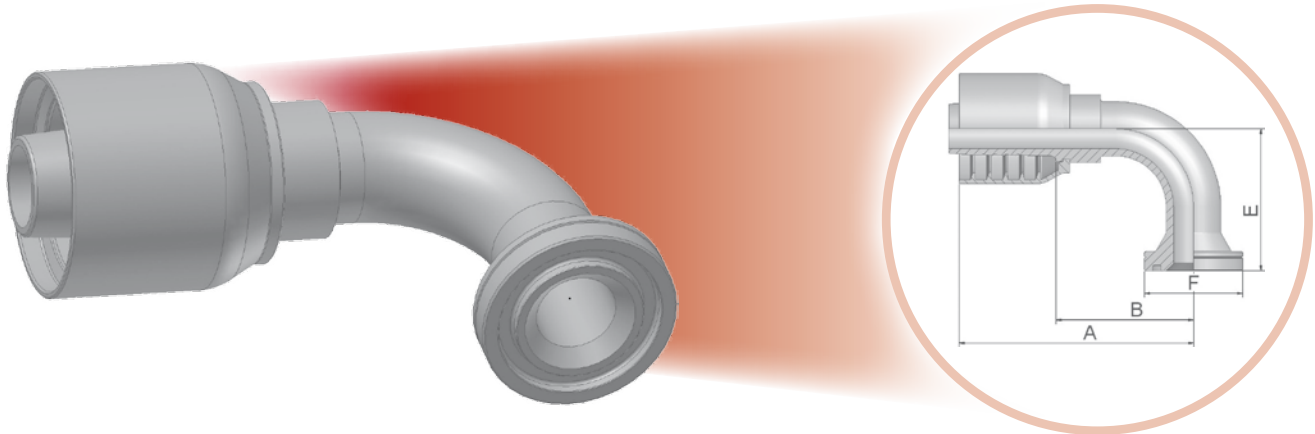

6N – SAE Code 62 Flange Head – 90° Elbow

ISO 12151-3-E-S – SFS 90° – 6000 psi



Approved fitting series for hose types:



XXXX-XX-XX Part Number 	 Hose I.D.				 End connection	A	B	E	F
	DN	Inch	Size	mm					
16N70-8-8	12	1/2	-8	12,7	1/2	74	39	41	32
16N70-8-10	16	5/8	-10	15,9	1/2	95	56	54	32
16N70-12-10	16	5/8	-10	15,9	3/4	92	55	54	41
16N70-16-10	16	5/8	-10	15,9	1	86	46	54	48
16N70-8-12	20	3/4	-12	19,1	1/2	81	42	54	32
16N70-12-12	20	3/4	-12	19,1	3/4	98	58	54	41
16N70-16-12	20	3/4	-12	19,1	1	93	53	53	48
16N70-12-16	25	1	-16	25,4	3/4	113	66	57	41
16N70-16-16	25	1	-16	25,4	1	111	64	70	48
16N70-20-16	25	1	-16	25,4	1-1/4	115	68	68	54
16N70-20-20	32	1-1/4	-20	31,8	1-1/4	130	82	70	54
16N70-24-20	32	1-1/4	-20	31,8	1-1/2	130	82	70	64
16N70-24-24	40	1-1/2	-24	38,1	1-1/2	156	101	81	64

Find SAE flange halves in section Eb.
 Fittings with standard O-ring seals can be used for temperatures from -30 °C up to +105 °C.
 Find O-rings in section E. Special O-rings are available on request.
 Material: steel chromium(VI) free plated

Information about standard products or non-standard products can be found in the current price list.
 Dimensions shown may be changed at any time without prior notice.





JC – Female ORFS – Swivel – Straight – Short

ISO 12151-1-SWSA – SAE J516 – ORFS



Approved fitting series for hose types:



XXXX·XX·XX Part Number 	 Hose I.D.				 Thread UNF	A	B	 H	 W
	DN	Inch	Size	mm					
1JC70-6-6-SM	10	3/8	-6	9,5	11/16x16	49	20	19	22
1JC70-8-6-SM	10	3/8	-6	9,5	13/16x16	51	22	19	24
1JC70-8-8-SM	12	1/2	-8	12,7	13/16x16	56	24	22	24
1JC70-10-8-SM	12	1/2	-8	12,7	1x14	59	24	24	30
1JC70-12-8-SM	12	1/2	-8	12,7	1-3/16x12	63	28	32	36
1JC70-8-10-SM	16	5/8	-10	15,9	13/16x16	59	22	22	24
1JC70-10-10-SM	16	5/8	-10	15,9	1x14	64	24	24	30
1JC70-12-10-SM	16	5/8	-10	15,9	1-3/16x12	68	29	32	36
1JC70-12-12-SM	20	3/4	-12	19,1	1-3/16x12	68	29	32	36
1JC70-16-12-SM	20	3/4	-12	19,1	1-7/16x12	72	33	36	41
1JC70-16-16-SM	25	1	-16	25,4	1-7/16x12	80	35	36	41
1JC70-20-20-SM	32	1-1/4	-20	31,8	1-11/16x12	85	36	50	50
1JC70-24-24-SM	40	1-1/2	-24	38,1	2x12	102	42	50	60

Material: steel chromium(VI) free plated
SM: Metric Hexagon

Information about standard products or non-standard products can be found in the current price list.
Dimensions shown may be changed at any time without prior notice.



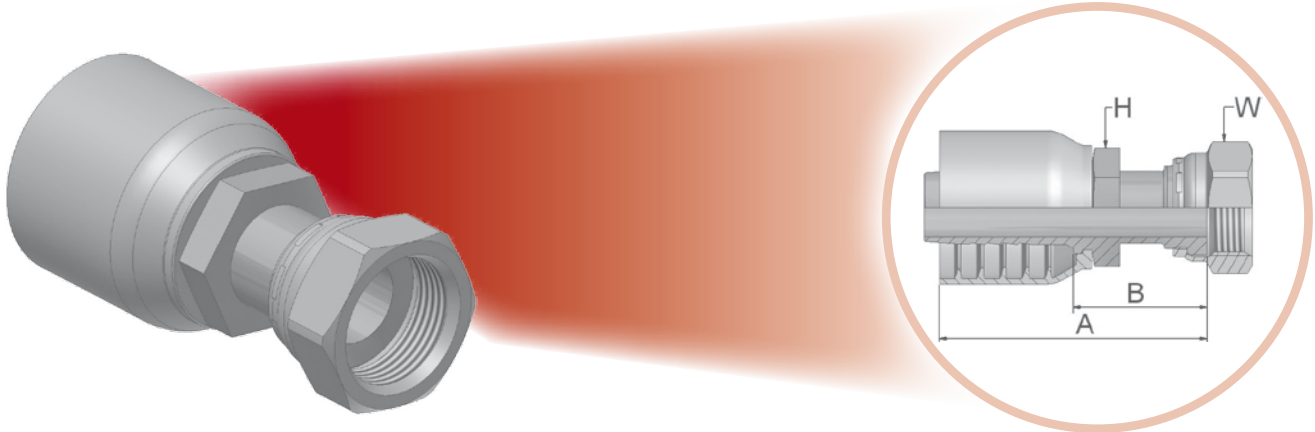

JS = ORFS Swivel Female (Long)

ISO 12151-1-SWSB – SAE J516 – ORFS



Approved fitting series for hose types:



XXXX-XX-XX Part Number 	 Hose I.D.				 Thread UNF	A	B	 H	 W
	DN	Inch	Size	mm					
1JS70-6-6-SM	10	3/8	-6	9,5	11/16x16	58	29	17	22
1JS70-8-6-SM	10	3/8	-6	9,5	13/16x16	67	38	19	24
1JS70-8-8-SM	12	1/2	-8	12,7	13/16x16	68	33	22	24
1JS70-10-8-SM	12	1/2	-8	12,7	1x14	74	39	24	30
1JS70-10-10-SM	16	5/8	-10	15,9	1x14	79	39	24	30
1JS70-12-12-SM	20	3/4	-12	19,1	1-3/16x12	84	45	30	36
1JS70-16-12-SM	20	3/4	-12	19,1	1-7/16x12	86	47	36	41
1JS70-16-16-SM	25	1	-16	25,4	1-7/16x12	92	51	36	41
1JS70-20-16-SM	25	1	-16	25,4	1-11/16x12	93	47	41	50
1JS70-20-20-SM	32	1-1/4	-20	31,8	1-11/16x12	96	49	46	50
1JS70-24-24-SM	40	1-1/2	-24	38,1	2x12	118	58	50	60

Material: steel chromium(VI) free plated
SM: Metric Hexagon

Information about standard products or non-standard products can be found in the current price list.
Dimensions shown may be changed at any time without prior notice.



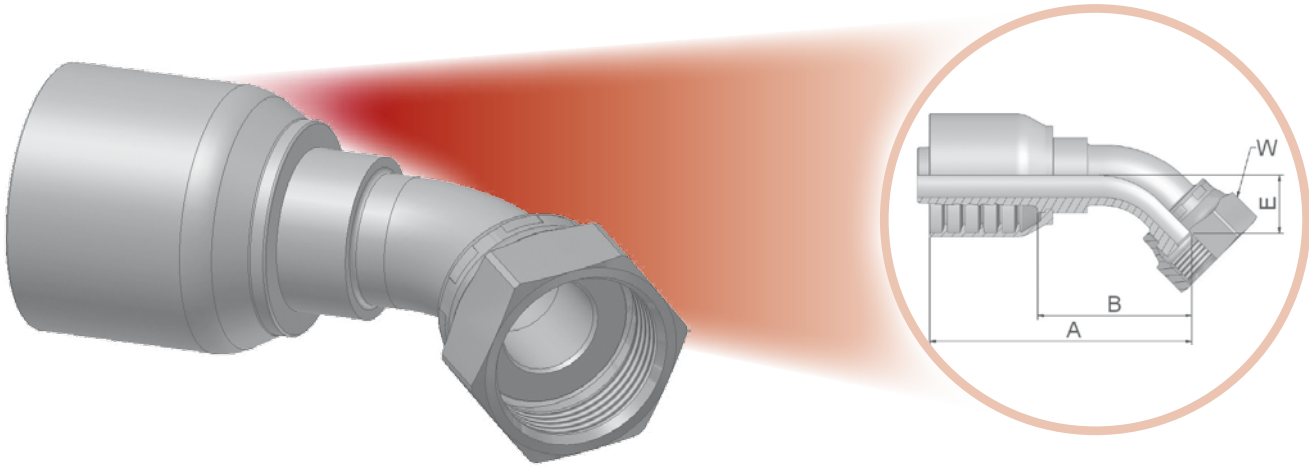

J7 - Female ORFS - Swivel - 45° Elbow - ISO 12151-1 - SWE 45°

ISO 12151-1-SWE45 - SAE J516 - ORFS 45°



Approved fitting series for hose types:



XXXX-XX-XX Part Number 	 Hose I.D.				 Thread UNF	A	B	E	 W
	DN	Inch	Size	mm					
1J770-6-6-SM	10	3/8	-6	9,5	11/16x16	62	33	11	22
1J770-6-8-SM	12	1/2	-8	12,7	11/16x16	68	33	11	22
1J770-8-8-SM	12	1/2	-8	12,7	13/16x16	72	37	15	24
1J770-10-8-SM	12	1/2	-8	12,7	1x14	81	46	17	30
1J770-10-10-SM	16	5/8	-10	15,9	1x14	83	44	16	30
1J770-12-10-SM	16	5/8	-10	15,9	1-3/16x12	90	53	21	36
1J770-12-12-SM	20	3/4	-12	19,1	1-3/16x12	92	53	21	36
1J770-16-12-SM	20	3/4	-12	19,1	1-7/16x12	95	56	24	41
1J770-16-16-SM	25	1	-16	25,4	1-7/16x12	112	66	24	41
1J770-20-20-SM	32	1-1/4	-20	31,8	1-11/16x12	130	82	27	50
1J770-24-24-SM	40	1.1/2	-24	38,1	2x12	169	109	40	60

Material: steel chromium(VI) free plated
SM: Metric Hexagon

Information about standard products or non-standard products can be found in the current price list.
Dimensions shown may be changed at any time without prior notice.



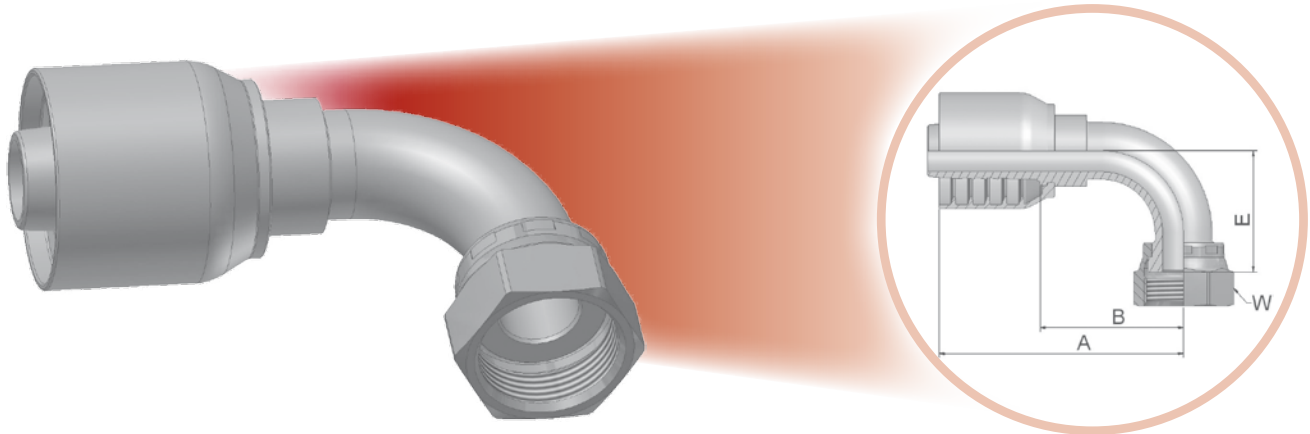

J9 – Female ORFS – Swivel – 90° Elbow – Short Drop

ISO 12151-1-SWES – SAE J516 – ORFS 90°



Approved fitting series for hose types:



XXXX-XX-XX Part Number 	 Hose I.D.				 Thread UNF	A	B	E	 W
	DN	Inch	Size	mm					
1J970-6-6-SM	10	3/8	-6	9,5	11/16x16	58	29	23	22
1J970-8-6-SM	10	3/8	-6	9,5	13/16x16	58	29	29	24
1J970-8-8-SM	12	1/2	-8	12,7	13/16x16	70	35	29	24
1J970-10-8-SM	12	1/2	-8	12,7	1x14	73	38	32	30
1J970-12-8-SM	12	1/2	-8	12,7	1-3/16x12	76	41	48	36
1J970-10-10-SM	16	5/8	-10	15,9	1x14	78	39	33	30
1J970-12-10-SM	16	5/8	-10	15,9	1-3/16x12	86	50	48	36
1J970-12-12-SM	20	3/4	-12	19,1	1-3/16x12	89	50	48	36
1J970-16-12-SM	20	3/4	-12	19,1	1-7/16x12	89	49	56	41
1J970-16-16-SM	25	1	-16	25,4	1-7/16x12	111	64	56	41
1J970-20-20-SM	32	1-1/4	-20	31,8	1-11/16x12	130	83	64	50
1J970-24-24-SM	40	1-1/2	-24	38,1	2x12	162	101	82	60

Material: steel chromium(VI) free plated
SM: Metric Hexagon

Information about standard products or non-standard products can be found in the current price list.
Dimensions shown may be changed at any time without prior notice.



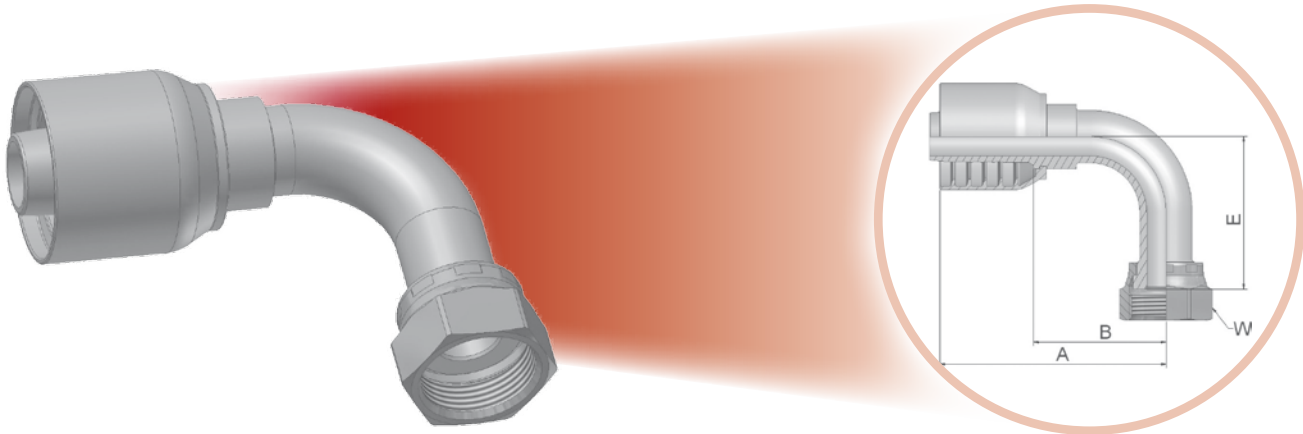

J1 - Female ORFS - Swivel - 90° Elbow - Long Drop

ISO 12151-1-SWEL - SAE J 516 - ORFS 90° L



Approved fitting series for hose types:



XXXX-XX-XX Part Number 	 Hose I.D.				 Thread UNF	A	B	E	 W
	DN	Inch	Size	mm		mm	mm	mm	mm
1J170-8-8-SM	12	1/2	-8	12,7	13/16x16	71	36	64	24
1J170-10-8-SM	12	1/2	-8	12,7	1x14	73	38	70	30
1J170-10-10-SM	16	5/8	-10	15,9	1x14	78	39	70	30
1J170-12-10-SM	16	5/8	-10	15,9	1-3/16x12	76	40	96	36
1J170-16-16-SM	25	1	-16	25,4	1-7/16x12	111	64	114	41

Material: steel chromium(VI) free plated
SM: Metric Hexagon

Information about standard products or non-standard products can be found in the current price list.
Dimensions shown may be changed at any time without prior notice.



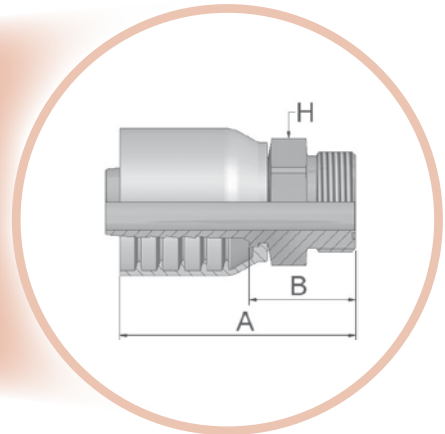
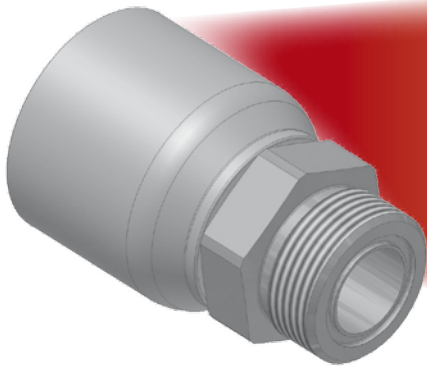

JM - ORFS Male

ISO 12151-1-S – SAE J516



Approved fitting series for hose types:



XXXX-XX-XX Part Number 	Hose I.D. 				Thread UNF 	A	B	H 
	DN	Inch	Size	mm				
1JM70-6-6-SM	10	3/8	-6	9,5	11/16x16	53	24	19
1JM70-8-6-SM	10	3/8	-6	9,5	13/16x16	56	27	22
1JM70-8-8-SM	12	1/2	-8	12,7	13/16x16	62	27	22
1JM70-10-8-SM	12	1/2	-8	12,7	1x14	67	32	27
1JM70-10-10-SM	16	5/8	-10	15,9	1x14	71	32	27
1JM70-12-10-SM	16	5/8	-10	15,9	1-3/16x12	74	35	32
1JM70-12-12-SM	20	3/4	-12	19,1	1-3/16x12	74	35	32
1JM70-16-12-SM	20	3/4	-12	19,1	1-7/16x12	74	35	41
1JM70-16-16-SM	25	1	-16	25,4	1-7/16x12	84	39	41
1JM70-20-20-SM	32	1-1/4	-20	31,8	1-11/16x12	85	37	46

JM fittings are supplied without O-ring.
Find O-rings in section E. Special O-rings are available on request.
Material: steel chromium(VI) free plated
SM: Metric Hexagon





Information about standard products or non-standard products can be found in the current price list.
Dimensions shown may be changed at any time without prior notice.

FG – Male French Gas Series – Rigid – Straight (24° Cone)



Approved fitting series for hose types:



XXXX.XX.XX Part Number 	 Hose I.D.				 Thread metric	Tube O.D.	A	B	 H
	DN	Inch	Size	mm		mm	mm	mm	mm
1FG70-17-8	12	1/2	-8	12,7	M24x1,5	16,75	62	27	24
1FG70-21-10	16	5/8	-10	15,9	M30x1,5	21,25	70	30	30
1FG70-27-12	20	3/4	-12	19,1	M36x1,5	26,75	70	30	36
1FG70-33-16	25	1	-16	25,4	M45x1,5	33,50	82	36	46

Material: steel chromium(VI) free plated





Information about standard products or non-standard products can be found in the current price list.
Dimensions shown may be changed at any time without prior notice.

F4 - Female French Gas Series – Swivel – Straight (Ball Nose)



Approved fitting series for hose types:



XXXX-XX-XX Part Number 	 Hose I.D.				 Thread metric	Tube O.D.	A	B	 W
	DN	Inch	Size	mm		mm	mm	mm	mm
1F470-13-6	10	3/8	-6	9,5	M20x1,5	13	52	22	24
1F470-17-8	12	1/2	-8	12,7	M24x1,5	17	60	25	30
1F470-21-10	16	5/8	-10	15,9	M30x1,5	21	64	25	36
1F470-27-12	20	3/4	-12	19,1	M36x1,5	27	70	31	46
1F470-33-16°	25	1	-16	25,4	M45x1,5	33	77	32	55

° Assembly on Parkrimp® 2 machine only.
Material: steel chromium(VI) free plated

Information about standard products or non-standard products can be found in the current price list.
Dimensions shown may be changed at any time without prior notice.

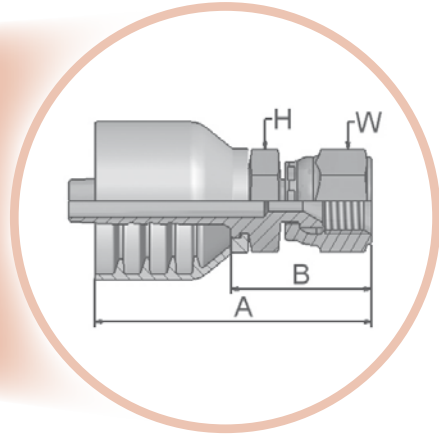
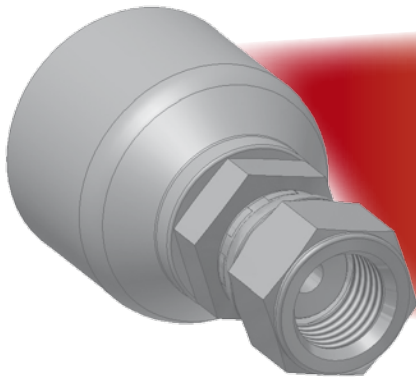

MU- Female Metric – Swivel – Straight (30° Flare)

JIS B8363 - MU



Approved fitting series for hose types:

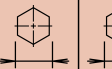
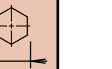

XXXX.XX.XX Part Number 	 Hose I.D.				 Thread metric	A	B	 H	 W
	DN	Inch	Size	mm					
1MU70-6-6	10	3/8	-6	9,5	M18x1,5	62	33	24	24
1MU70-8-8	12	1/2	-8	12,7	M22x1,5	59	24	27	27
1MU70-12-12	20	3/4	-12	19,1	M27x2	81	41	36	36

Material: steel chromium(VI) free plated

Information about standard products or non-standard products can be found in the current price list. Dimensions shown may be changed at any time without prior notice.





XU - Female Metric - Swivel - Straight (30° Flare)

JIS B 8363



Approved fitting series for hose types:



XXXX-XX-XX Part Number 	 Hose I.D.				 Thread metric	A mm	B mm	 H mm	 W mm
	DN	Inch	Size	mm					
1XU70-10-10	16	5/8	-10	15,9	M24x1,5	67	28	30	32
1XU70-12-12	20	3/4	-12	19,1	M30x1,5	68	28	32	36
1XU70-16-16	25	1	-16	25,4	M33x1,5	82	35	36	41

Material: steel chromium(VI) free plated

Information about standard products or non-standard products can be found in the current price list.
Dimensions shown may be changed at any time without prior notice.



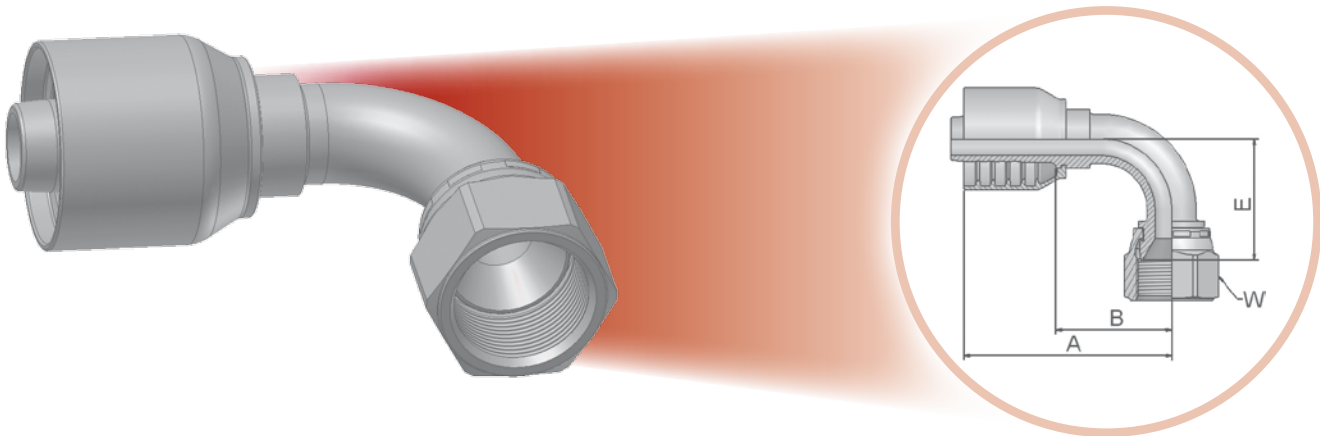

XY - Female Metric - Swivel - 90° Elbow (30° Flare)

JIS B8363



Approved fitting series for hose types:













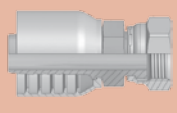
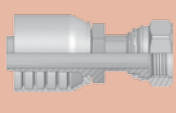
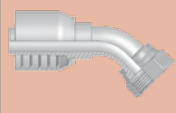
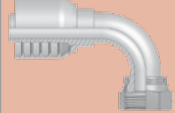



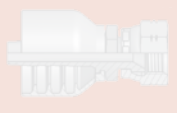



XXXX-XX-XX Part Number 	 Hose I.D.				 Thread metric	A	B	E	 W
	DN	Inch	Size	mm					
1XY70-10-10	16	5/8	-10	15,9	M24x1,5	80	41	41	32
1XY70-12-12	20	3/4	-12	19,1	M30x1,5	89	49	52	36











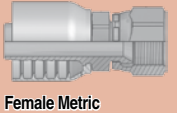
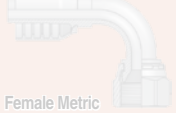

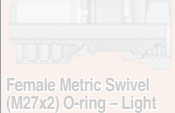







Material: steel chromium(VI) free plated

Information about standard products or non-standard products can be found in the current price list. Dimensions shown may be changed at any time without prior notice.

Fittings Overview 71 Series

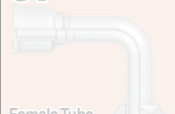
DIN	CA Dc-1 DKOL	CE Dc-2 DKOL 45°	CF Dc-3 DKOL 90°	D0 Dc-4 CEL	C0 DKM or DKLL	C3 DKL	C4 DKL 45°
	C5 DKL 90°	1D BEL	DD BEL 45°	5D BEL 90°	C9 Dc-5 DKOS	0C Dc-6 DKOS 45°	1C Dc-7 DKOS 90°
	D2 Dc-8 CES	C6 DKS	3D BES	49 Metric Banjo	9B Swivel Female 45° Elbow	9C Swivel Female 90° Elbow	
	92 Dc-9 DKR	B1 Dc-10 DKR 45°	B2 Dc-11 DKR 90°	B4 DKR 90° (Compact)	EA DKOR	EB DKOR 45°	EC DKOR 90°
	D9 Dc-12 AGR	91 AGR-K	B5 Female BSP Parallel Pipe - Swivel (Flat Seat)	34 Standpipe			
	01 Dc-13 AGN	02 Female NPTF Pipe Rigid - Straight	03 Dc-14 AGJ	04 Male SAE 45° - Rigid	05 Male SAE Straight Thread with O-ring - Rigid	06 Dc-15 68 DKJ	08 AGS
	13 Male NPTF Pipe Swivel	33 Male JIC 37° - Rigid	37 Dc-16 3V DKJ 45°	39 Dc-17 3W DKJ 90°	41 3Y DKJ 90° L	L9 DKJ 90° M	93 Female JIC 37° - Swivel (Block Type)
	15 Dc-18 4A SFL	16 Dc-19 SFL 22.5°	17 Dc-20 4F SFL 45°	19 Dc-21 4N SFL 90°	6A Dc-22 SFS	6F Dc-23 SFS 45°	6N Dc-24 SFS 90°
89 SFL 90° - long	XA Caterpillar Flange Head	XF Caterpillar Flange Head 45°	XG Caterpillar Flange Head 60°	XN Caterpillar Flange Head 90°			

ORFS	JC Dc-25  ORFS - short	JS Dc-26  ORFS - long	J7 Dc-27  ORFS 45°	J9 Dc-28  ORFS Female 90°	J1  ORFS 90° - extra long	J5  ORFS 90° - long	JM  ORFS Male
	JD  Male ORFS - Bulkhead with Locknut (with O-ring)						
JIS	FU  GUI	GU  GUO	MU  Female Metric Swivel - (30° Flare)	MZ  Female Metric Swivel - (30° Flare)	UT  Male BSP Taper Pipe Rigid - (60° Cone)		
	French Standard	FG  Male Rigid Gas Series - (24° Cone)	F2  Female Swivel Gas Series	F4  Female Swivel Gas Series - (Ball Nose)	F6  Male Metric (24° Cone)	F9  Swivel Female Metric (Ball Nose)	FA  Metric Male for Agriculture Valves
High Pressure Cleaning		CW  Power Cleaner Connection	PW  Male Kärcher Metric Cleaning Hose Fitting - Rigid	NW  Female Kärcher Metric Cleaning Hose Fitting - (New Design)			

others	XU Dc-29  Female Metric Swivel - (30° Flare)	XY  Female Metric Swivel - (30° Flare)	DK  Male Metric L - Rigid Bulkhead with Locknut (24° Cone)	DX  Female Metric Swivel (M27x2) O-ring - Light Series	FF  Metru-Lok Swivel Female	AF  Male BSP Parallel Pipe Rigid - Straight (with O-ring Seal)	NM  Male BSP Parallel Pipe - L Series - Rigid Straight - ED-Seal
	YW  Male Standpipe - Rigid - Straight - A-Lok	VW121  BSP Swivel Female	82  Push-Lok Union	DP  Metric Swivel Female Tee / Male Stud	DR  Metric Swivel Female Tee	5C  60° Cone Swivel Female	6C  60° Cone Swivel Female - 45° Elbow
	7C  60° Cone Swivel Female - 90° Elbow	5S  Female Tube O-ring Swivel - Short Pilot	5H  Female Tube O-ring Swivel - 45° Elbow Short Pilot	5T  Female Tube O-ring Swivel 90° Elbow Short Pilot	59PT  Male Tube O-ring Swivel - Long Pilot Charge Port at 180° for R134a	5LPT  Female Tube O-ring Swivel - 90° Elbow Long Pilot Charge Port at 180° for R134a	T1  Male Refrigerant Tube Mender - Straight (with Nut and Ferrule)



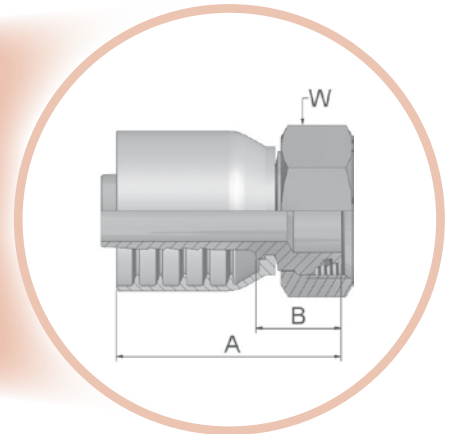
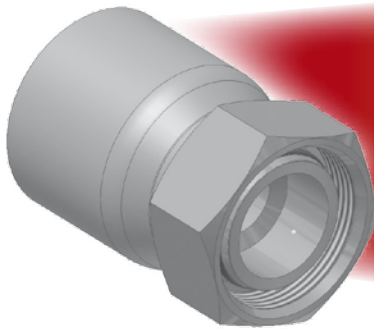

CA - Female Metric 24° - Light Series with O-ring - Swivel - Straight

ISO 12151-2-SWS-L - DKOL



Approved fitting series for hose types:



XXXX-XX-XX Part Number 	 Hose I.D.				 Thread metric	Tube O.D.	A	B	 W
	DN	Inch	Size	mm					
1CA71-12-6	10	3/8	-6	9,5	M18x1,5	12	53	24	22
1CA70-15-8	12	1/2	-8	12,7	M22x1,5	15	62	27	27
1CA71-18-10	16	5/8	-10	15,9	M26x1,5	18	62	26	32
1CA71-22-12	20	3/4	-12	19,1	M30x2	22	63	24	36
1CA71-35-16	25	1	-16	25,4	M45x2	35	74	29	50
1CA71-35-20	32	1.1/4	-20	31,8	M45x2	35	82	35	50
1CA71-42-24	40	1-1/2	-24	38,1	M52x2	42	99	39	60

Fittings with standard O-ring seals can be used for temperatures from -30 °C up to +105 °C.

Find O-rings in section E. Special O-rings are available on request.

Attention: Hose assembly pressure is reduced; see page Ab-3

Material: steel chromium(VI) free plated

Information about standard products or non-standard products can be found in the current price list.
Dimensions shown may be changed at any time without prior notice.



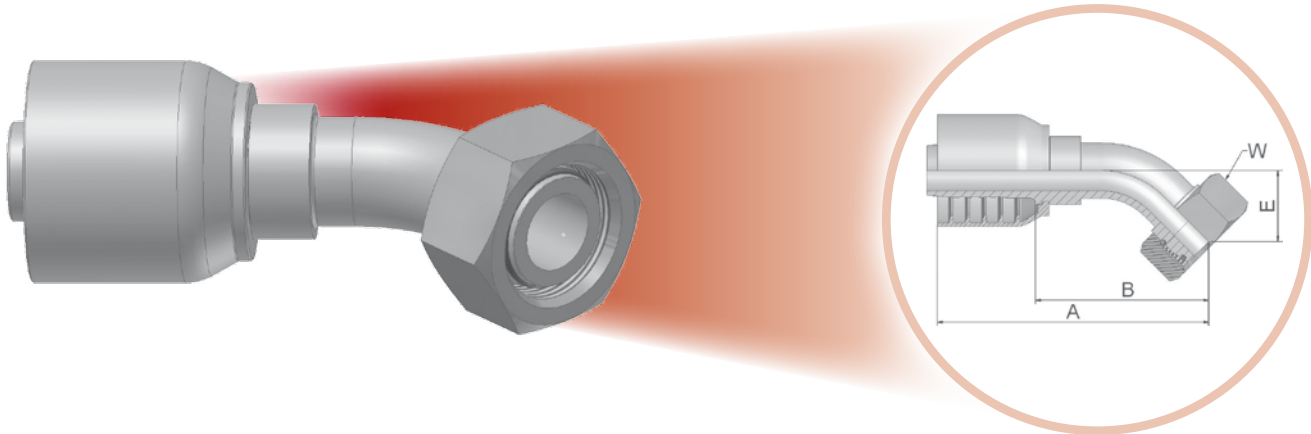

CE – Female Metric 24° – Light Series with O-ring – Swivel – 45° Elbow

ISO 12151-2-SWE45-L – DKOL 45°



Approved fitting series for hose types:



XXXX-XX-XX Part Number 	Hose I.D. 				Thread metric 	Tube O.D. mm	A mm	B mm	E mm	W mm 
	DN	Inch	Size	mm						
1CE71-12-6	10	3/8	-6	9,5	M18x1,5	12	69	40	20	22
1CE71-15-8	12	1/2	-8	12,7	M22x1,5	15	85	50	24	27
1CE71-18-10	16	5/8	-10	15,9	M26x1,5	18	89	49	23	32
1CE71-22-12	20	3/4	-12	19,1	M30x2	22	98	58	26	36
1CE71-28-16	25	1	-16	25,4	M36x2	28	125	80	34	41
1CE71-35-20	32	1-1/4	-20	31,8	M45x2	35	141	94	38	50
1CE71-42-24	40	1-1/2	-24	38,1	M52x2	42	178	118	49	60

Fittings with standard O-ring seals can be used for temperatures from -30 °C up to +105 °C.

Find O-rings in section E. Special O-rings are available on request.

Attention: Hose assembly pressure is reduced; see page Ab-3

Material: steel chromium(VI) free plated

Information about standard products or non-standard products can be found in the current price list.
Dimensions shown may be changed at any time without prior notice.

CF – Female Metric 24° – Light Series with O-ring – Swivel – 90° Elbow

ISO 12151-2-SWE-L – DKOL 90°

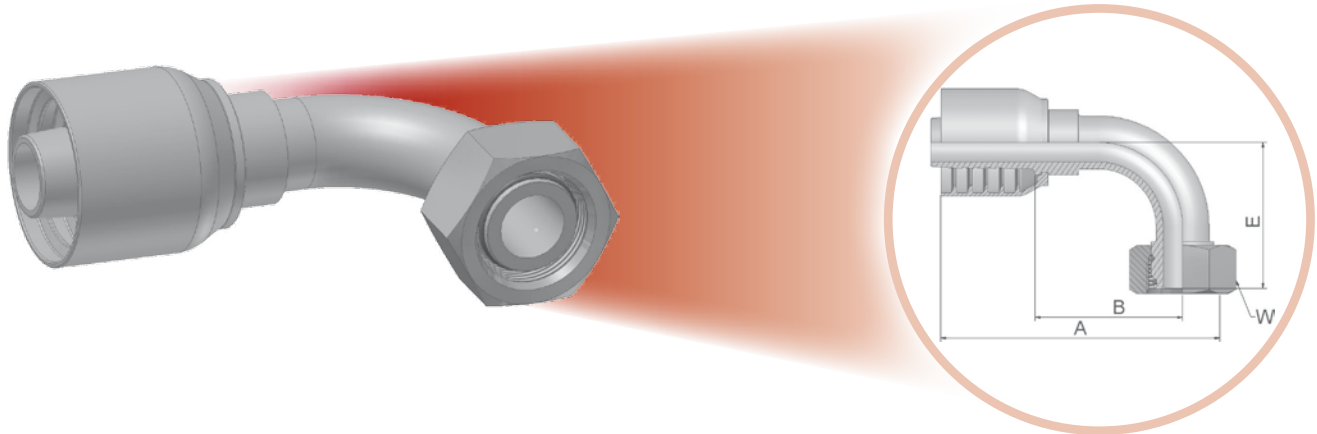

Approved fitting series for hose types:



XXXX-XX-XX Part Number 	Hose I.D.				Thread metric	Tube O.D.	A	B	E	W
	DN	Inch	Size	mm						
1CF71-12-6	10	3/8	-6	9,5	M18x1,5	12	67	38	37	22
1CF71-15-8	12	1/2	-8	12,7	M22x1,5	15	74	39	45	27
1CF71-18-10	16	5/8	-10	15,9	M26x1,5	18	79	42	49	32
1CF71-22-12	20	3/4	-12	19,1	M30x2	22	89	49	55	36
1CF71-28-16	25	1	-16	25,4	M36x2	28	113	68	73	41
1CF71-35-16	25	1	-16	25,4	M45x2	35	113	68	69	50
1CF71-35-20	32	1-1/4	-20	31,8	M45x2	35	130	83	79	50
1CF71-42-24	40	1-1/2	-24	38,1	M52x2	42	161	101	101	60

Fittings with standard O-ring seals can be used for temperatures from -30 °C up to +105 °C.
Find O-rings in section E. Special O-rings are available on request.
Attention: Hose assembly pressure is reduced; see page Ab-3
Material: steel chromium(VI) free plated

Information about standard products or non-standard products can be found in the current price list.
Dimensions shown may be changed at any time without prior notice.



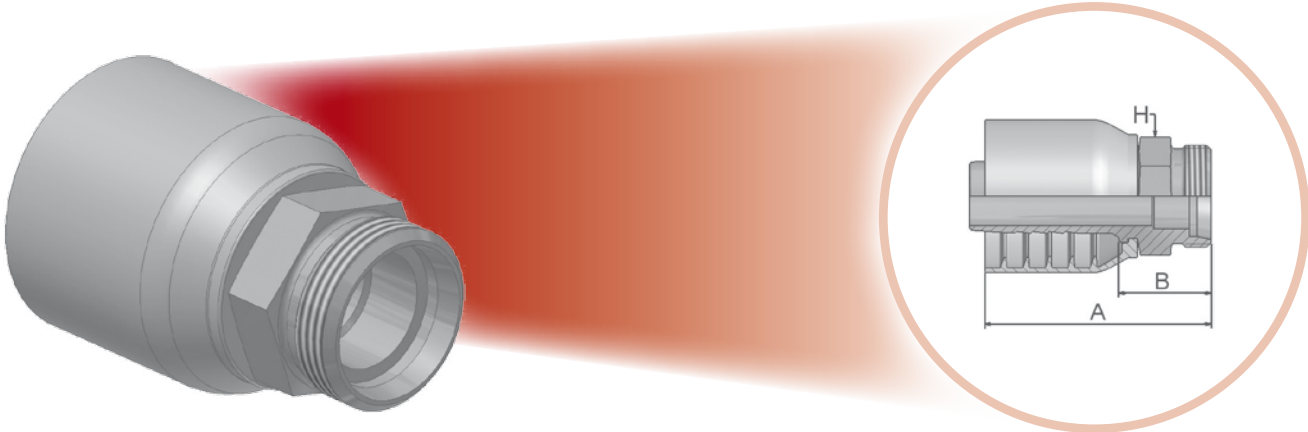

DO – Male Metric 24° – Light Series – Rigid – Straight

ISO 12151-2-S-L – CEL



Approved fitting series for hose types:



XXXX.XX.XX Part Number 	 Hose I.D.				 Thread metric	Tube O.D.	A	B	 H
	DN	Inch	Size	mm		mm	mm	mm	mm
1D071-42-24	40	1-1/2	-24	38,1	M52x2	42	99	39	55

Attention: Hose assembly pressure is reduced; see page Ab-3
Material: steel chromium(VI) free plated





C9 – Female Metric 24° – Heavy Series with O-ring – Swivel – Straight

ISO 12151-2-SWS-S – DKOS



Approved fitting series for hose types:



XXXX-XX-XX Part Number 	 Hose I.D.				 Thread metric	Tube O.D. mm	A mm	B mm	 W mm
	DN	Inch	Size	mm					
1C971-12-6	10	3/8	-6	9,5	M20x1,5	12	52	22	24
1C971-16-8	12	1/2	-8	12,7	M24x1,5	16	59	24	30
1C971-20-10	16	5/8	-10	15,9	M30x2	20	66	27	36
1C971-20-12	20	3/4	-12	19,1	M30x2	20	66	27	36
1C971-25-12	20	3/4	-12	19,1	M36x2	25	68	29	46
1C971-25-16	25	1	-16	25,4	M36x2	25	78	33	46
1C971-30-16	25	1	-16	25,4	M42x2	30	80	33	50
1C971-38-20°	32	1-1/4	-20	31,8	M52x2	38	80	33	60
1C971-38-24	40	1-1/2	-24	38,1	M52x2	38	99	39	60

° Assembly on Parkrimp® 2 machine only.
 Fittings with standard O-ring seals can be used for temperatures from -30 °C up to +105 °C.
 Find O-rings in section E. Special O-rings are available on request.
 Material: steel chromium(VI) free plated

Information about standard products or non-standard products can be found in the current price list.
 Dimensions shown may be changed at any time without prior notice.



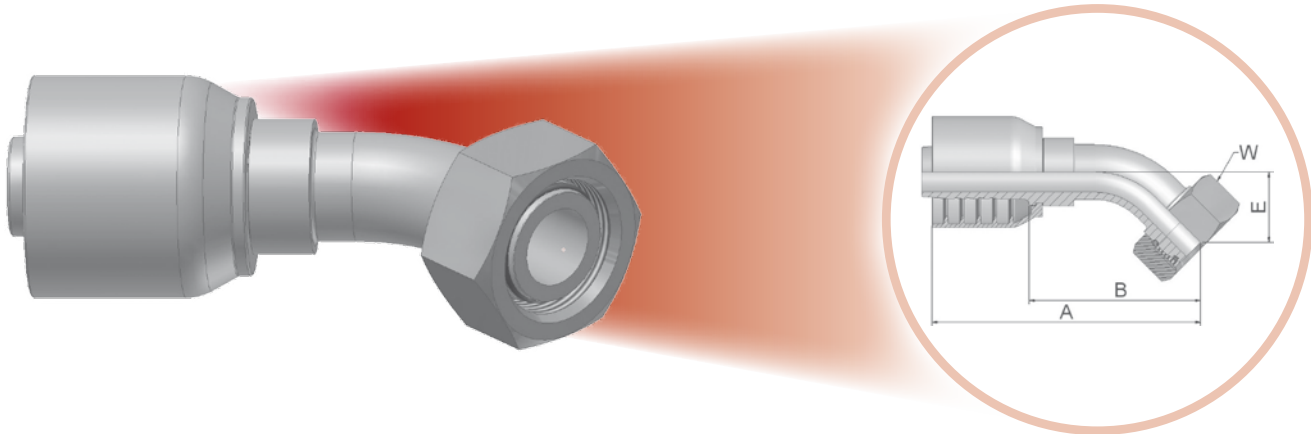

OC – Female Metric 24° – Heavy Series with O-ring – Swivel – 45° Elbow

ISO 12151-2-SWE45-S – DKOS 45°



Approved fitting series for hose types:



XXXX-XX-XX Part Number 	 Hose I.D.				 Thread metric	Tube O.D.	A	B	E	 W
	DN	Inch	Size	mm						
10C71-12-6	10	3/8	-6	9,5	M20x1,5	12	69	40	20	24
10C71-14-6	10	3/8	-6	9,5	M22x1,5	14	76	46	20	27
10C71-16-8	12	1/2	-8	12,7	M24x1,5	16	83	48	24	30
10C71-16-10	16	5/8	-10	15,9	M24x1,5	16	89	49	23	30
10C71-20-10	16	5/8	-10	15,9	M30x2	20	91	52	25	36
10C71-25-12	20	3/4	-12	19,1	M36x2	25	101	61	30	46
10C71-30-16	25	1	-16	25,4	M42x2	30	124	79	36	50
10C71-38-20°	32	1-1/4	-20	31,8	M52x2	38	142	95	38	60
10C71-38-24	40	1.1/2	-24	38,1	M52x2	38	178	118	49	60

° Assembly on Parkrimp® 2 machine only.
Fittings with standard O-ring seals can be used for temperatures from -30 °C up to +105 °C.
Find O-rings in section E. Special O-rings are available on request.
Material: steel chromium(VI) free plated

Information about standard products or non-standard products can be found in the current price list.
Dimensions shown may be changed at any time without prior notice.



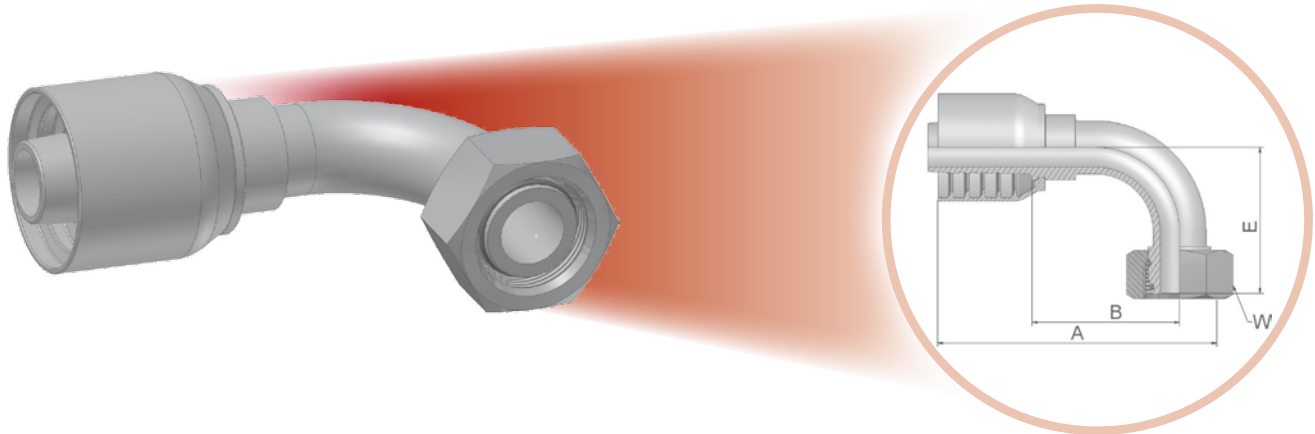

1C – Female Metric 24° – Heavy Series with O-ring – Swivel – 90° Elbow

ISO 12151-2-SWE-S – DKOS 90°



Approved fitting series for hose types:



XXXX-XX-XX Part Number 	 Hose I.D.				 Thread metric	 Tube O.D.	A	B	E	 W
	DN	Inch	Size	mm		mm	mm	mm	mm	mm
11C71-12-8	12	1/2	-8	12,7	M20x1,5	12	71	36	41	24
11C71-16-8	12	1/2	-8	12,7	M24x1,5	16	72	37	45	30
11C71-20-10	16	5/8	-10	15,9	M30x2	20	79	40	48	36
11C71-20-12	20	3/4	-12	19,1	M30x2	20	89	50	58	36
11C71-25-12	20	3/4	-12	19,1	M36x2	25	89	49	59	46
11C71-30-16	25	1	-16	25,4	M42x2	30	115	68	76	50
11C71-38-20°	32	1-1/4	-20	31,8	M52x2	38	130	83	80	60

° Assembly on Parkrimp® 2 machine only.
 Fittings with standard O-ring seals can be used for temperatures from -30 °C up to +105 °C.
 Find O-rings in section E. Special O-rings are available on request.
 Material: steel chromium(VI) free plated

Information about standard products or non-standard products can be found in the current price list.
 Dimensions shown may be changed at any time without prior notice.





D2 – Male Metric 24° – Heavy Series – Rigid – Straight

ISO 12151-2-S-S – CES



Approved fitting series for hose types:



XXXX·XX·XX Part Number 	Hose I.D. 				Thread metric 	Tube O.D. mm	A mm	B mm	H mm 
	DN	Inch	Size	mm					
1D271-12-6	10	3/8	-6	9,5	M20x1,5	12	53	24	22
1D271-16-8	12	1/2	-8	12,7	M24x1,5	16	62	28	24
1D271-25-12	20	3/4	-12	19,1	M36x2	25	73	33	36
1D271-25-16	25	1	-16	25,4	M36x2	25	82	37	36
1D271-30-16	25	1	-16	25,4	M42x2	30	85	40	46
1D271-38-20	32	1-1/4	-20	31,8	M52x2	38	91	44	55

Material: steel chromium(VI) free plated

Information about standard products or non-standard products can be found in the current price list. Dimensions shown may be changed at any time without prior notice.





92 - Female BSP Parallel Pipe – Swivel – Straight (60° Cone)

BS5200-A – DKR



Approved fitting series for hose types:



XXXX-XX-XX Part Number 	Hose I.D. 				Thread BSP 	A mm	B mm	W mm 
	DN	Inch	Size	mm				
19271-6-6	10	3/8	-6	9,5	3/8x19	49	20	22
19271-8-8	12	1/2	-8	12,7	1/2x14	57	22	27
19271-10-10	16	5/8	-10	15,9	5/8x14	57	21	30
19271-12-12	20	3/4	-12	19,1	3/4x14	61	22	32
19271-16-16	25	1	-16	25,4	1x11	73	26	41
19271-20-20	32	1-1/4	-20	31,8	1-1/4x11	79	32	50
19271-24-24	40	1-1/2	-24	38,1	1-1/2x11	93	33	60
19271-32-32	50	2	-32	50,8	2x11	101	35	70

Material: steel chromium(VI) free plated

Information about standard products or non-standard products can be found in the current price list.
Dimensions shown may be changed at any time without prior notice.



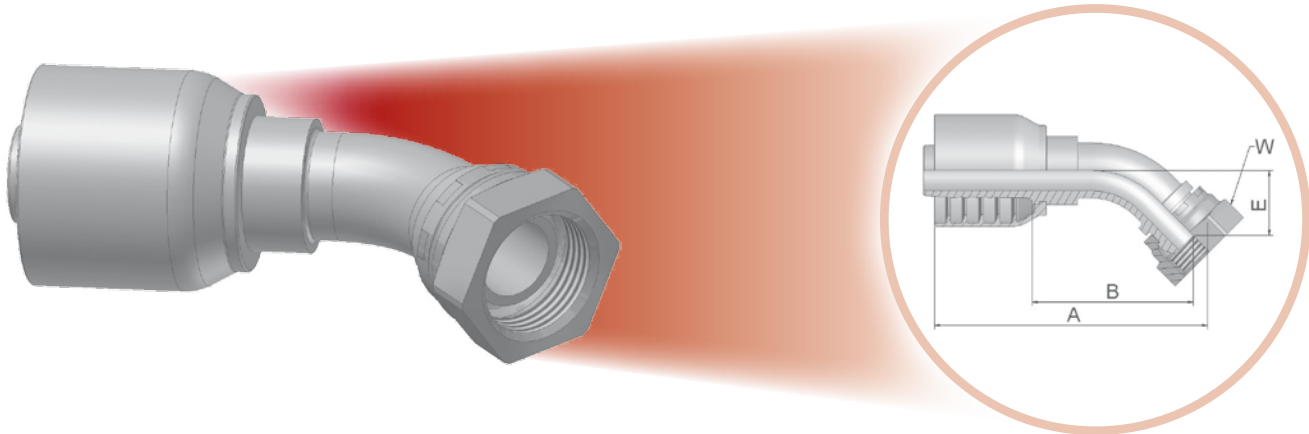

B1 - Female BSP Parallel Pipe - Swivel - 45° Elbow (60° Cone)

BS 5200-D - DKR 45°



Approved fitting series for hose types:



XXXX.XX.XX Part Number 	 Hose I.D.				 Thread BSP	A	B	E	 W
	DN	Inch	Size	mm					
1B171-6-6	10	3/8	-6	9,5	3/8x19	67	37	17	22
1B171-8-8	12	1/2	-8	12,7	1/2x14	79	45	20	27
1B171-10-10	16	5/8	-10	15,9	5/8x14	90	50	24	30
1B171-12-12	20	3/4	-12	19,1	3/4x14	96	57	25	32
1B171-16-16	25	1	-16	25,4	1x11	120	75	31	41
1B171-20-20	32	1-1/4	-20	31,8	1-1/4x11	139	91	35	50
1B171-24-24	40	1-1/2	-24	38,1	1-1/2x11	169	108	38	55
1B171-32-32	50	2	-32	50,8	2x11	190	125	55	70

Material: steel chromium(VI) free plated

Information about standard products or non-standard products can be found in the current price list. Dimensions shown may be changed at any time without prior notice.



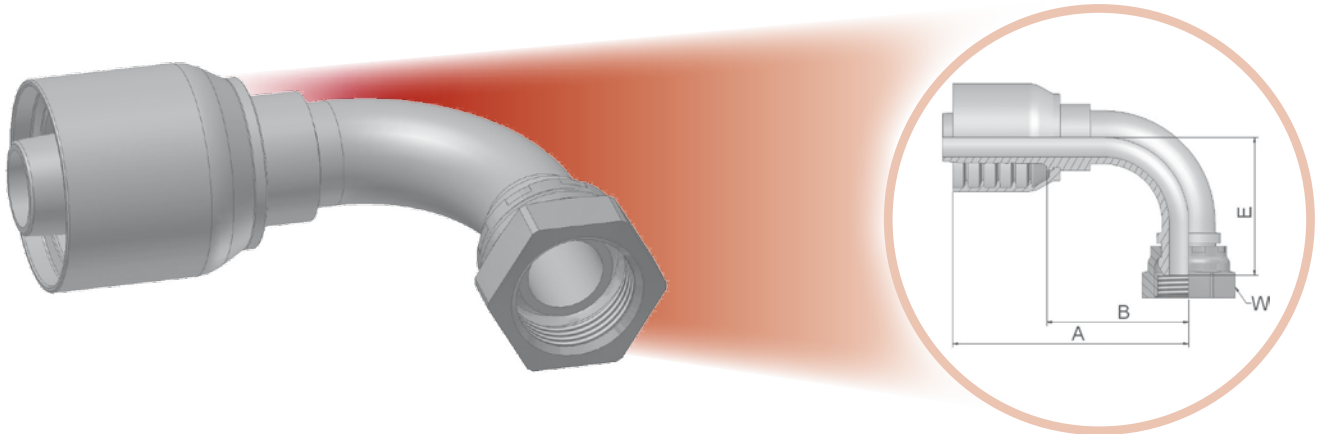

B2 – Female BSP Parallel Pipe – Swivel – 90° Elbow (60° Cone)

BS 5200-B – DKR 90°



Approved fitting series for hose types:



XXXX-XX-XX Part Number 	 Hose I.D.				 Thread BSP	A	B	E	 W
	DN	Inch	Size	mm					
1B271-8-8	12	1/2	-8	12,7	1/2x14	79	45	20	27
1B271-12-12	20	3/4	-12	19,1	3/4x14	89	50	53	32
1B271-16-16	25	1	-16	25,4	1x11	114	69	69	41
1B271-20-20	32	1-1/4	-20	31,8	1-1/4x11	130	82	76	50
1B271-24-24	40	1-1/2	-24	38,1	1-1/2x11	163	102	86	55
1B271-32-32	50	2	-32	50,8	2x11	197	132	106	70

Material: steel chromium(VI) free plated

Information about standard products or non-standard products can be found in the current price list.
Dimensions shown may be changed at any time without prior notice.





D9 – Male BSP Parallel Pipe – Rigid – Straight (60° Cone)

BS5200 – AGR



Approved fitting series for hose types:



XXXX-XX-XX Part Number 	 Hose I.D.				 Thread BSP	A mm	B mm	 H mm
	DN	Inch	Size	mm				
1D971-12-12	20	3/4	-12	19,1	3/4x14	70	30	32
1D971-16-16	25	1	-16	25,4	1x11	82	35	41
1D971-20-20	32	1-1/4	-20	31,8	1-1/4x11	92	45	50
1D971-24-24	40	1-1/2	-24	38,1	1-1/2x11	109	49	55
1D971-32-32	50	2	-32	50,8	2x11	117	53	75

Material: steel chromium(VI) free plated

Information about standard products or non-standard products can be found in the current price list.
Dimensions shown may be changed at any time without prior notice.

01 - Male NPTF Pipe - Rigid - Straight

SAE J476A - J516

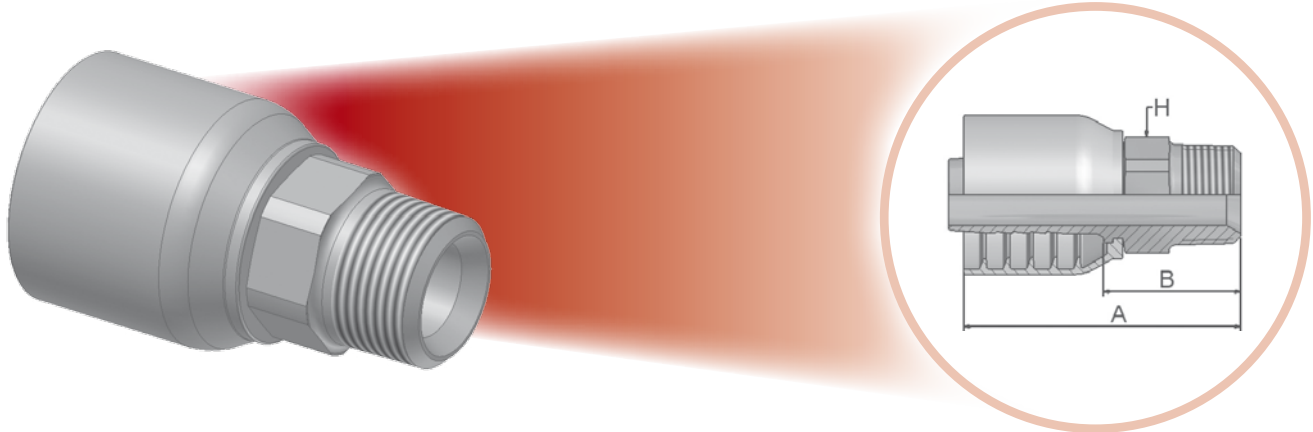

Approved fitting series for hose types:



XXXX-XX-XX Part Number 	Hose I.D.				Thread NPTF	A mm	B mm	H mm / Inch
	DN	Inch	Size	mm				
10171-6-6-SM	10	3/8	-6	9,5	3/8x18	60	31	19
10171-8-6-SM	10	3/8	-6	9,5	1/2x14	61	32	22
10171-8-8	12	1/2	-8	12,7	1/2x14	72	41	7/8
10171-12-8-SM	12	1/2	-8	12,7	3/4x14	68	33	27
10171-12-10-SM	16	5/8	-10	15,9	3/4x14	71	34	27
10171-12-12-SM	20	3/4	-12	19,1	3/4x14	79	39	32
10171-16-12-SM	20	3/4	-12	19,1	1x11-1/2	79	39	36
10171-12-16	25	1	-16	25,4	3/4x14	88	46	1-3/8
10171-16-16-SM	25	1	-16	25,4	1x11-1/2	86	42	36
10171-20-16	25	1	-16	25,4	1-1/4x11-1/2	89	48	1-11/16
10171-20-20-SM	32	1-1/4	-20	31,8	1-1/4x11-1/2	104	57	46
10171-24-20	32	1-1/4	-20	31,8	1-1/2x11-1/2	96	53	2
10171-24-24-SM	40	1.1/2	-24	38,1	1-1/2x11-1/2	112	51	50
10171-32-32	50	2	-32	50,8	2x11-1/2	18	64	2-1/2

Material: steel chromium(VI) free plated
SM: Metric Hexagon

Information about standard products or non-standard products can be found in the current price list.
Dimensions shown may be changed at any time without prior notice.



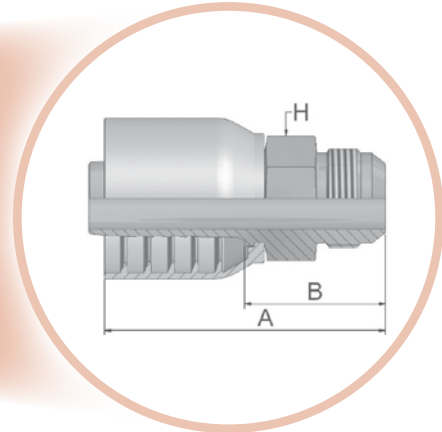
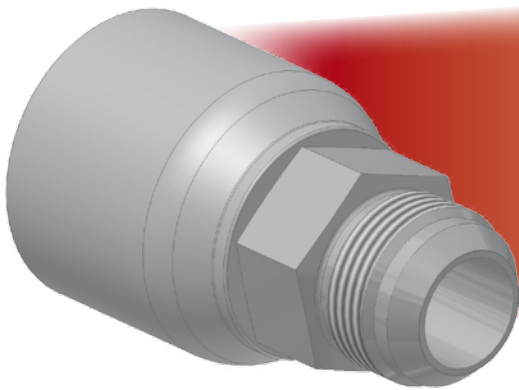

03 - Male JIC 37° - Rigid - Straight

ISO12151-5-S – AGJ



Approved fitting series for hose types:



XXXX-XX-XX Part Number 	 Hose I.D.				 Thread UNF	A	B	 H
	DN	Inch	Size	mm				
10371-6-6-SM	10	3/8	-6	9,5	9/16x18	60	31	19
10371-8-6-SM	10	3/8	-6	9,5	3/4x16	59	29	19
10371-8-8-SM	12	1/2	-8	12,7	3/4x16	68	37	19
10371-10-8-SM	12	1/2	-8	12,7	7/8x14	67	32	24
10371-12-8-SM	12	1/2	-8	12,7	1-1/16x12	71	36	27
10371-8-10-SM	16	5/8	-10	15,9	3/4x16	73	33	24
10371-12-10-SM	16	5/8	-10	15,9	1-1/16x12	75	36	27
10371-10-12-SM	20	3/4	-12	19,1	7/8x14	77	38	27
10371-12-12-SM	20	3/4	-12	19,1	1-1/16x12	81	42	27
10371-16-12-SM	20	3/4	-12	19,1	1-5/16x12	78	38	36
10371-16-16-SM	25	1	-16	25,4	1-5/16x12	92	47	36
10371-20-16-SM	25	1	-16	25,4	1-5/8x12	88	43	46
10371-20-20-SM	32	1-1/4	-20	31,8	1-5/8x12	101	53	46
10371-24-24-SM	40	1-1/2	-24	38,1	1-7/8x12	110	49	50

Material: steel chromium(VI) free plated
SM: Metric Hexagon

Information about standard products or non-standard products can be found in the current price list.
Dimensions shown may be changed at any time without prior notice.

06/68 – Female – JIC 37° / SAE 45° Dual Flare – Swivel – Straight

ISO12151-5-SWS – DKJ

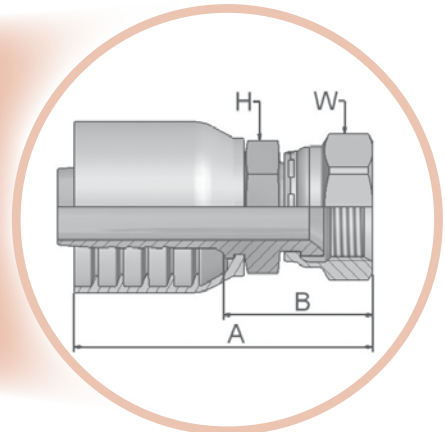
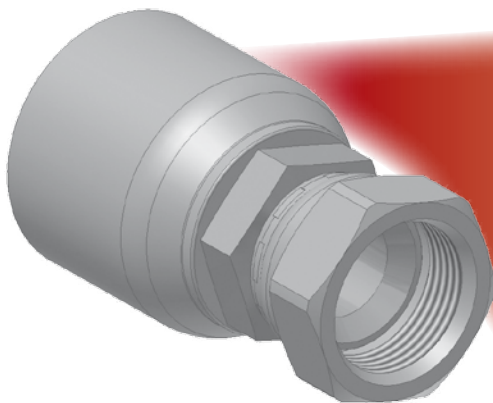





Approved fitting series for hose types:



71

774/721TC

XXXX-XX-XX Part Number 	 Hose I.D.				 Thread UNF	A	B	 H	 W
	DN	Inch	Size	mm					
10671-6-6-SM	10	3/8	-6	9,5	9/16x18	58	29	17	19
10671-8-6-SM	10	3/8	-6	9,5	3/4x16	61	32	19	22
10671-8-8-SM	12	1/2	-8	12,7	3/4x16	67	32	22	22
10671-10-8-SM*	12	1/2	-8	12,7	7/8x14	70	35	22	27
10671-8-10-SM	16	5/8	-10	15,9	3/4x16	73	36	24	22
16871-10-10-SM	16	5/8	-10	15,9	7/8x14	75	35	24	27
10671-12-10-SM	16	5/8	-10	15,9	1-1/16x12	78	41	27	32
10671-10-12-SM	20	3/4	-12	19,1	7/8x14	74	35	27	27
10671-12-12-SM	20	3/4	-12	19,1	1-1/16x12	80	41	27	32
10671-14-12-SM	20	3/4	-12	19,1	1-3/16x12	81	42	32	36
10671-16-12-SM	20	3/4	-12	19,1	1-5/16x12	84	45	32	41
10671-12-16-SM	25	1	-16	25,4	1-1/16x12	89	44	36	32
10671-16-16-SM	25	1	-16	25,4	1-5/16x12	92	47	36	41
10671-20-16	25	1	-16	25,4	1-5/8x12	98	53	1-7/8	2"
10671-16-20-SM	32	1-1/4	-20	31,8	1-5/16x12	97	50	46	41
10671-20-20-SM	32	1-1/4	-20	31,8	1-5/8x12	100	53	46	50
10671-24-20-SM	32	1-1/4	-20	31,8	1-7/8x12	105	58	55	60
10671-24-24-SM	40	1-1/2	-24	38,1	1-7/8x12	119	64	55	60
10671-32-32	50	2	-32	50,8	2-1/2x12	136	81	2-1/2	2-7/8

* These fittings contain a dual seat that accepts both JIC (37°) and SAE (45°) male configurations.
The other sizes accept the JIC (37°) male configurations only.
Material: steel chromium(VI) free plated
SM: Metric Hexagon

Information about standard products or non-standard products can be found in the current price list.
Dimensions shown may be changed at any time without prior notice.



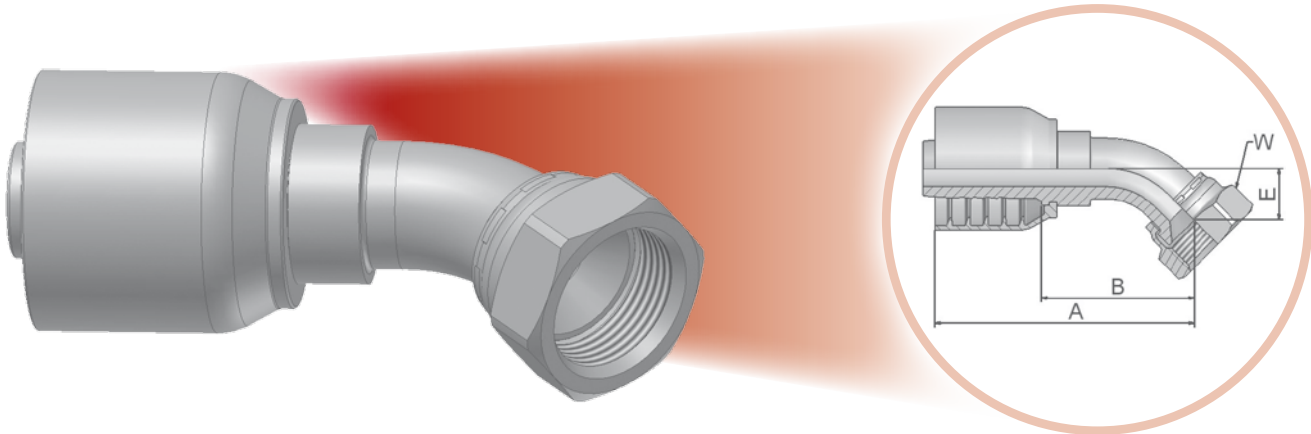

37/3V – Female JIC 37° /SAE 45° – Dual Flare – Swivel Female 45° Elbow

ISO 12151-5-SWE45 – DKJ 45°



Approved fitting series for hose types:



XXXX-XX-XX Part Number 	 Hose I.D.				 Thread UNF	A	B	E	 W
	DN	Inch	Size	mm					
13771-6-6-SM	10	3/8	-6	9,5	9/16x18	61	31	10	19
13771-8-8-SM*	12	1/2	-8	12,7	3/4x16	73	38	14	22
13771-10-10-SM*	16	5/8	-10	15,9	7/8x14	83	44	17	27
13771-12-12-SM	20	3/4	-12	19,1	1-1/16x12	91	52	20	32
13770-16-12-SM	20	3/4	-12	19,1	1-5/16x12	95	56	24	41
13771-16-16-SM	25	1	-16	25,4	1-5/16x12	111	66	24	41
13771-20-16-SM	25	1	-16	25,4	1-5/8x12	113	67	26	50
13771-20-20-SM	32	1-1/4	-20	31,8	1-5/8x12	134	87	31	50
13771-24-24-SM	40	1.1/2	-24	38,1	1-7/8x12	174	114	46	60

* These fittings contain a dual seat that accepts both JIC (37°) and SAE (45°) male configurations.

The other sizes accept the JIC (37°) male configurations only.

Material: steel chromium(VI) free plated

SM: Metric Hexagon

Information about standard products or non-standard products can be found in the current price list.
Dimensions shown may be changed at any time without prior notice.



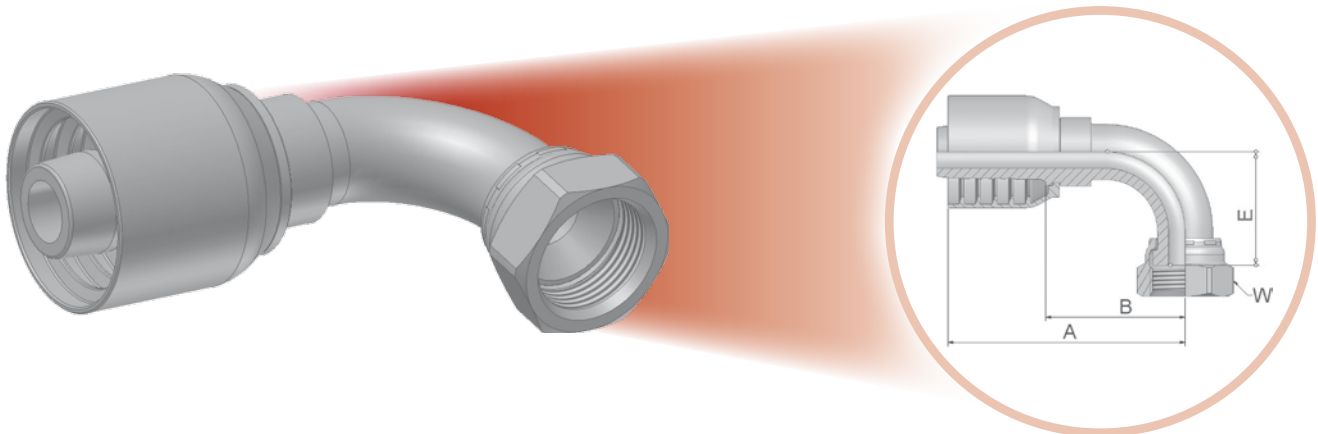

39/3W – Female JIC 37° / SAE 45° – Dual Flare – Swivel Female 90° Elbow

ISO 12151-5-SWES – DKJ 90°



Approved fitting series for hose types:



XXXX-XX-XX Part Number 	Hose I.D. 				Thread UNF 	A	B	E	W 
	DN	Inch	Size	mm					
13971-6-6-SM	10	3/8	-6	9,5	9/16x18	58	29	22	19
13971-6-8-SM	12	1/2	-8	12,7	9/16x18	64	29	22	19
13971-8-8-SM*	12	1/2	-8	12,7	3/4x16	68	33	28	22
13971-10-8-SM*	12	1/2	-8	12,7	7/8x14	74	39	32	27
13971-10-10-SM*	16	5/8	-10	15,9	7/8x14	80	41	33	27
13971-12-12-SM	20	3/4	-12	19,1	1-1/16x12	89	50	48	32
13971-16-12-SM	20	3/4	-12	19,1	1-5/16x12	89	50	51	41
13971-12-16-SM	25	1	-16	25,4	1-1/16x12	99	54	46	32
13971-16-16-SM	25	1	-16	25,4	1-5/16x12	109	64	55	41
13971-20-16-SM	25	1	-16	25,4	1-5/8x12	109	64	62	50
13971-20-20-SM	32	1-1/4	-20	31,8	1-5/8x12	130	83	70	50
13971-24-20-SM°	32	1-1/4	-20	31,8	1-7/8x12	130	82	80	60
13971-24-24-SM	40	1-1/2	-24	38,1	1-7/8x12	161	101	101	60

° Assembly on Parkrimp® 2 machine only.

* These fittings contain a dual seat that accepts both JIC (37°) and SAE (45°) male configurations.

The other sizes accept the JIC (37°) male configurations only.

Material: steel chromium(VI) free plated

SM: Metric Hexagon

Information about standard products or non-standard products can be found in the current price list.
Dimensions shown may be changed at any time without prior notice.



15 - SAE Code 61 - Flange Head - Straight

ISO 12151-3-S-L – SFL – 3000 psi



Approved fitting series for hose types:



XXXX-XX-XX Part Number 	 Hose I.D.				 End Connection	A mm	B mm	F mm
	DN	Inch	Size	mm				
11571-8-8	12	1/2	-8	12,7	1/2	89	54	30
11571-12-8	12	1/2	-8	12,7	3/4	85	55	38
11571-12-12	20	3/4	-12	19,1	3/4	98	59	38
11571-16-12	20	3/4	-12	19,1	1	70	31	45
11571-16-16	25	1	-16	25,4	1	108	63	45
11571-20-16	25	1	-16	25,4	1-1/4	82	36	51
11571-24-16	25	1	-16	25,4	1-1/2	111	66	60
11571-16-20	32	1-1/4	-20	31,8	1	120	72	45
11571-20-20	32	1-1/4	-20	31,8	1-1/4	120	78	51
11571-24-20	32	1-1/4	-20	31,8	1-1/2	82	35	60
11571-20-24	40	1-1/2	-24	38,1	1-1/4	138	77	51
11571-24-24	40	1-1/2	-24	38,1	1-1/2	140	80	60
11571-32-32	50	2	-32	50,8	2	144	79	71
11571-40-32	50	2	-32	50,8	2-1/2	148	94	84

Find SAE flange halves in section Eb.

Fittings with standard O-ring seals can be used for temperatures from -30 °C up to +105 °C.

Find O-rings in section E. Special O-rings are available on request.

Material: steel chromium(VI) free plated

Information about standard products or non-standard products can be found in the current price list.
Dimensions shown may be changed at any time without prior notice.

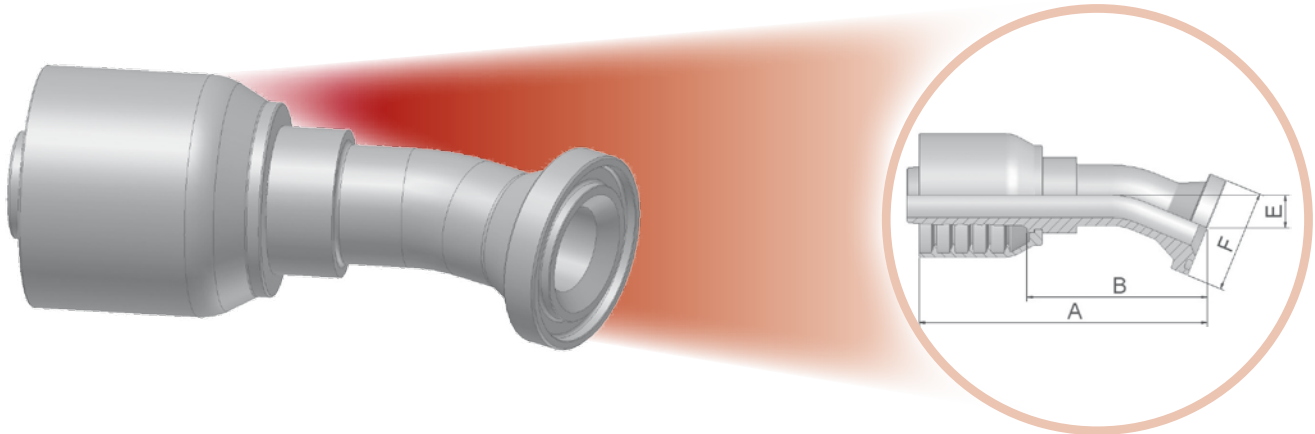

16 – SAE Code 61 – Flange Head – 22.5° Elbow

ISO 12151-3-E22ML – SFL 22.5° – 3000 psi



Approved fitting series for hose types:



XXXX-XX-XX Part Number 	 Hose I.D.				 End Connection	A	B	E	F
	DN	Inch	Size	mm					
11671-12-12	20	3/4	-12	19,1	3/4	105	65	11	38
11671-16-16	25	1	-16	25,4	1	125	80	11	45
11671-20-20	32	1-1/4	-20	31,8	1-1/4	139	92	13	51
11671-24-24	40	1-1/2	-24	38,1	1-1/2	149	94	16	60
11671-32-32	50	2	-32	50,8	2	185	131	22	71

Find SAE flange halves in section Eb.

Fittings with standard O-ring seals can be used for temperatures from -30 °C up to +105 °C.

Find O-rings in section E. Special O-rings are available on request.

Material: steel chromium(VI) free plated

Information about standard products or non-standard products can be found in the current price list.
Dimensions shown may be changed at any time without prior notice.

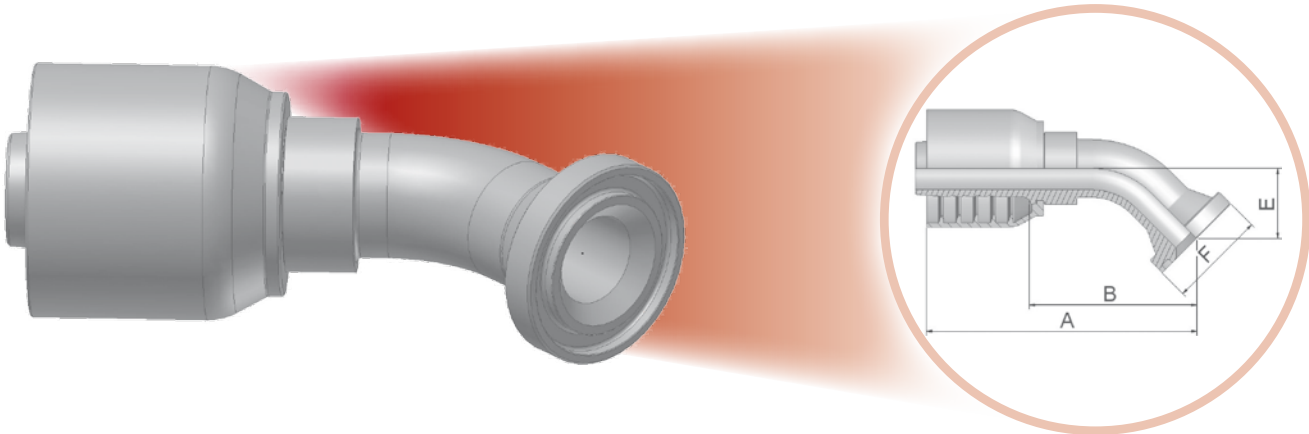

17 - SAE Code 61 - Flange Head - 45° Elbow

ISO 12151-3-E45-L - SFL 45° - 3000 psi



Approved fitting series for hose types:



XXXX.XX.XX Part Number 	 Hose I.D.				 End Connection	A	B	E	F
	DN	Inch	Size	mm		mm	mm	mm	mm
11771-8-8	12	1/2	-8	12,7	1/2	79	44	20	30
11771-12-12	20	3/4	-12	19,1	3/4	98	58	26	38
11771-16-16	25	1	-16	25,4	1	119	73	27	45
11771-20-16	25	1	-16	25,4	1-1/4	121	76	32	51
11771-20-20	32	1-1/4	-20	31,8	1-1/4	132	85	29	51
11771-24-20	32	1-1/4	-20	31,8	1-1/2	141	94	38	60
11771-24-24	40	1-1/2	-24	38,1	1-1/2	166	106	37	60
11771-32-32	50	2	-32	50,8	2	200	135	52	71

Find SAE flange halves in section Eb.

Fittings with standard O-ring seals can be used for temperatures from -30 °C up to +105 °C.

Find O-rings in section E. Special O-rings are available on request.

Material: steel chromium(VI) free plated

Information about standard products or non-standard products can be found in the current price list.
Dimensions shown may be changed at any time without prior notice.

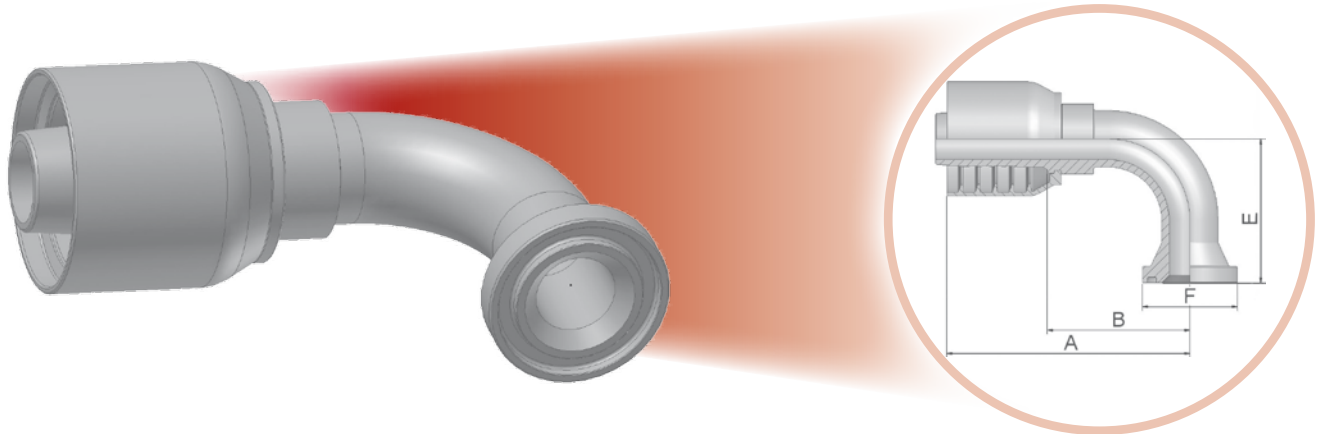

19 – SAE Code 61 – Flange Head – 90° Elbow

ISO 12151-3-E-L – SFL 90° – 3000 psi



Approved fitting series for hose types:



XXXX-XX-XX Part Number 	Hose I.D. 				End Connection 	A	B	E	F
	DN	Inch	Size	mm					
11971-8-8	12	1/2	-8	12,7	1/2	75	40	41	30
11971-12-10	16	5/8	-10	15,9	3/4	75	43	36	38
11971-12-12	20	3/4	-12	19,1	3/4	89	50	58	38
11971-16-12	20	3/4	-12	19,1	1	90	50	58	45
11971-16-16	25	1	-16	25,4	1	113	72	60	45
11971-20-16	25	1	-16	25,4	1-1/4	113	68	70	51
11971-24-16	25	1	-16	25,4	1-1/2	113	72	60	60
11971-16-20	32	1-1/4	-20	31,8	1	130	82	90	45
11971-20-20	32	1-1/4	-20	31,8	1-1/4	130	82	90	51
11971-24-20	32	1-1/4	-20	31,8	1-1/2	121	79	67	60
11971-24-24	40	1-1/2	-24	38,1	1-1/2	161	101	79	60
11971-32-32	50	2	-32	50,8	2	203	138	115	71

Find SAE flange halves in section Eb.

Fittings with standard O-ring seals can be used for temperatures from -30 °C up to +105 °C.

Find O-rings in section E. Special O-rings are available on request.

Material: steel chromium(VI) free plated

Information about standard products or non-standard products can be found in the current price list.
Dimensions shown may be changed at any time without prior notice.

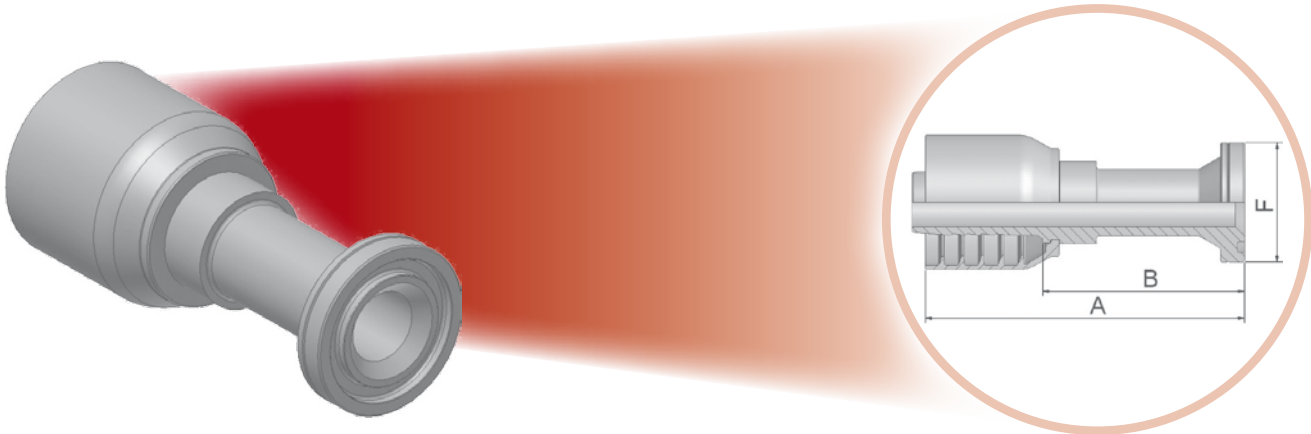

6A – SAE Code 62 – Flange – Straight

ISO 12151-3-S-S – SFS – 6000 psi



Approved fitting series for hose types:



XXXX-XX-XX Part Number 	 Hose I.D.				 End Connection	A	B	F
	DN	Inch	Size	mm				
16A71-8-8	12	1/2	-8	12,7	1/2	103	68	32
16A71-12-12	20	3/4	-12	19,1	3/4	105	66	41
16A71-16-12	20	3/4	-12	19,1	1	110	70	48
16A71-16-16	25	1	-16	25,4	1	127	82	48
16A71-20-16	25	1	-16	25,4	1-1/4	127	82	54
16A71-20-20	32	1-1/4	-20	31,8	1-1/4	130	83	54
16A71-24-20	32	1-1/4	-20	31,8	1-1/2	131	84	64
16A71-24-24	40	1-1/2	-24	38,1	1-1/2	163	107	64
16A71-32-32	50	2	-32	50,8	2	187	133	79

Find SAE flange halves in section Eb.

Fittings with standard O-ring seals can be used for temperatures from -30 °C up to +105 °C.

Find O-rings in section E. Special O-rings are available on request.

Material: steel chromium(VI) free plated

Information about standard products or non-standard products can be found in the current price list.
Dimensions shown may be changed at any time without prior notice.

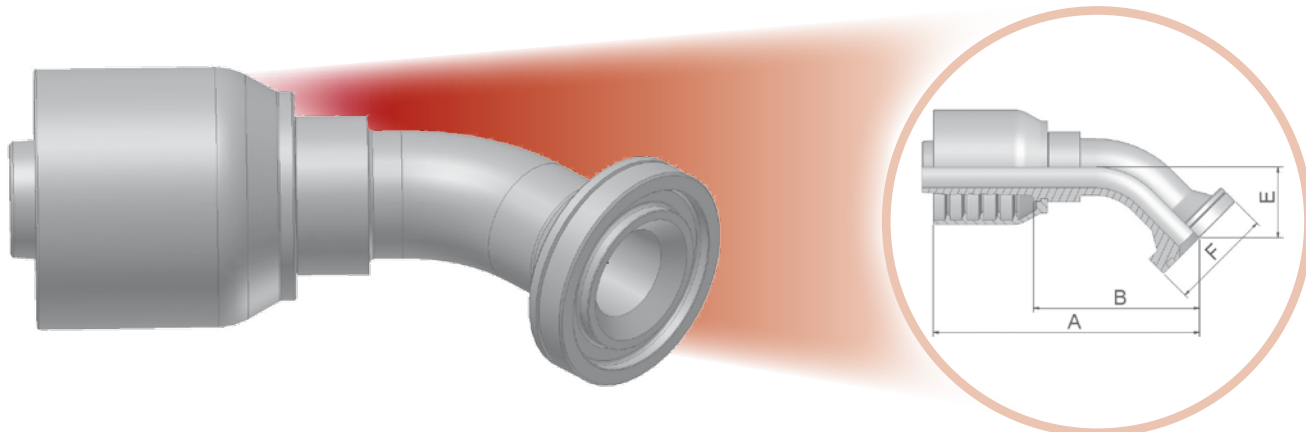

6F – SAE Flange 45° Elbow – Heavy Series

ISO 12151-3-E45-S – SFS 45° – 6000 psi



Approved fitting series for hose types:



XXXX-XX-XX Part Number 	 Hose I.D.				 End Connection	A	B	E	F
	DN	Inch	Size	mm		mm	mm	mm	mm
16F71-8-8	12	1/2	-8	12,7	1/2	81	46	19	32
16F71-12-12	20	3/4	-12	19,1	3/4	105	66	26	41
16F71-16-12	20	3/4	-12	19,1	1	101	62	26	48
16F71-12-16	25	1	-1	25,4	3/4	118	73	27	41
16F71-16-16	25	1	-16	25,4	1	117	77	27	48
16F71-20-16	25	1	-16	25,4	1-1/4	117	70	31	54
16F71-20-20	32	1-1/4	-20	31,8	1-1/4	141	94	38	54
16F71-24-20	32	1-1/4	-20	31,8	1-1/2	141	94	38	64
16F71-24-24	40	1-1/2	-24	38,1	1-1/2	173	113	44	64
16F71-32-32	50	2	-32	50,8	2	198	144	52	79

Find SAE flange halves in section Eb.

Fittings with standard O-ring seals can be used for temperatures from -30 °C up to +105 °C.

Find O-rings in section E. Special O-rings are available on request.

Material: steel chromium(VI) free plated

Information about standard products or non-standard products can be found in the current price list.
Dimensions shown may be changed at any time without prior notice.

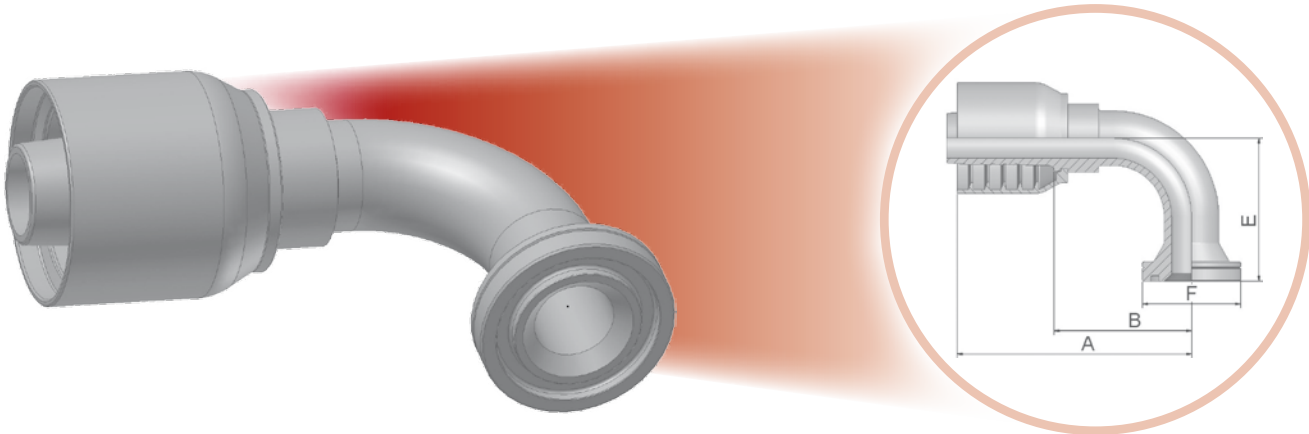

6N – SAE Code 62 Flange Head – 90° Elbow

ISO 12151-3-E-S – SFS 90° – 6000 psi



Approved fitting series for hose types:



XXXX-XX-XX Part Number 	 Hose I.D.				 End Connection	A	B	E	F
	DN	Inch	Size	mm		mm	mm	mm	mm
16N71-8-8	12	1/2	-1	12,7	1/2	74	39	41	32
16N71-8-12	20	3/4	-12	19,1	1/2	81	42	54	32
16N71-12-12	20	3/4	-12	19,1	3/4	98	59	54	41
16N71-16-12	20	3/4	-12	19,1	1	93	53	53	48
16N71-12-16	25	1	-16	25,4	3/4	113	66	57	41
16N71-16-16	25	1	-16	25,4	1	111	64	70	48
16N71-20-16	25	1	-16	25,4	1-1/4	115	68	61	54
16N71-20-20	32	1-1/4	-20	31,8	1-1/4	130	82	70	54
16N71-24-20	32	1-1/4	-20	31,8	1-1/2	130	82	70	64
16N71-24-24	40	1-1/2	-24	38,1	1-1/2	161	101	81	64
16N71-32-32	50	2	-32	50,8	2	188	134	114	79

Find SAE flange halves in section Eb.

Fittings with standard O-ring seals can be used for temperatures from -30 °C up to +105 °C.

Find O-rings in section E. Special O-rings are available on request.

Material: steel chromium(VI) free plated

Information about standard products or non-standard products can be found in the current price list.
Dimensions shown may be changed at any time without prior notice.



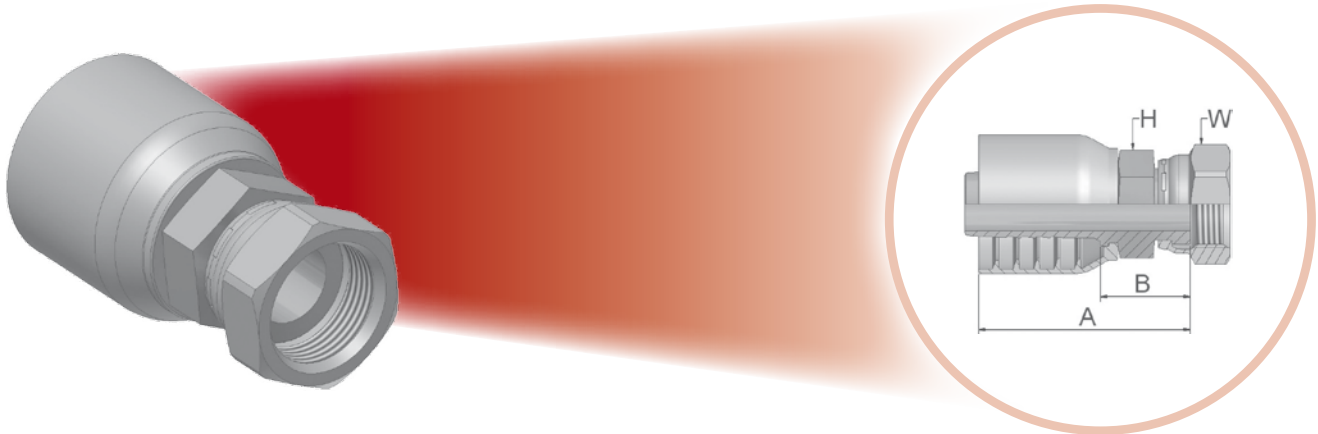

JC – Female ORFS – Swivel – Straight – Short

ISO 12151-1-SWSA – SAE J516 – ORFS



Approved fitting series for hose types:



XXXX-XX-XX Part Number 	 Hose I.D.				 Thread UNF	A	B	 H	 W
	DN	Inch	Size	mm					
1JC71-10-8-SM	12	1/2	-8	12,7	1x14	59	24	24	30
1JC71-10-10-SM	16	5/8	-10	15,9	1x14	64	24	24	30
1JC71-12-10-SM	16	5/8	-10	15,9	1-3/16x12	68	29	32	36
1JC71-12-12-SM	20	3/4	-12	19,1	1-3/16x12	68	29	32	36
1JC71-16-12-SM	20	3/4	-12	19,1	1-7/16x12	72	33	36	41
1JC71-12-16-SM	25	1	-16	25,4	1-3/16x12	76	31	36	36
1JC71-16-16-SM	25	1	-16	25,4	1-7/16x12	80	35	36	41
1JC71-20-16-SM	25	1	-16	25,4	1-11/16x12	79	34	41	50
1JC71-20-20-SM	32	1-1/4	-20	31,8	1-11/16x12	85	36	50	50
1JC71-24-24-SM	40	1-1/2	-24	38,1	2x12	102	42	50	60

Material: steel chromium(VI) free plated
SM: Metric Hexagon

Information about standard products or non-standard products can be found in the current price list.
Dimensions shown may be changed at any time without prior notice.



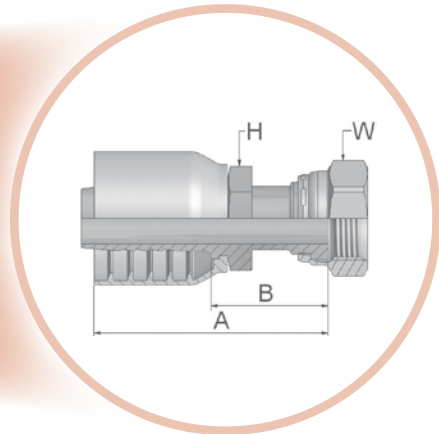
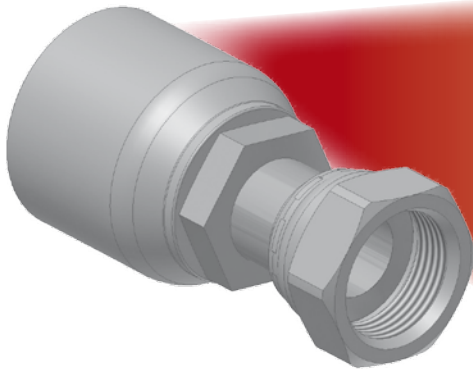

JS – ORFS Swivel Female (Long)

ISO 12151-1-SWSB – SAE J516 – ORFS



Approved fitting series for hose types:



XXXX-XX-XX Part Number 	 Hose I.D.				 Thread UNF	A	B	 H	 W
	DN	Inch	Size	mm					
1JS71-6-6-SM	10	3/8	-6	9,5	11/16x16	58	29	17	22
1JS71-8-8-SM	12	1/2	-8	12,7	13/16x16	68	33	22	24
1JS71-10-10-SM	16	5/8	-10	15,9	1x14	79	39	24	30
1JS71-10-12-SM	20	3/4	-12	19,1	1x14	78	39	27	30
1JS71-12-12-SM	20	3/4	-12	19,1	1-3/16x12	84	45	30	36
1JS71-16-12-SM	20	3/4	-12	19,1	1-7/16x12	86	47	36	41
1JS71-16-16-SM	25	1	-16	25,4	1-7/16x12	92	51	36	41
1JS71-20-16-SM	25	1	-16	25,4	1-11/16x12	93	47	41	50
1JS71-20-20-SM	32	1-1/4	-20	31,8	1-11/16x12	96	49	46	50
1JS71-24-24-SM	40	1-1/2	-24	38,1	2x12	118	58	50	60

Material: steel chromium(VI) free plated
SM: Metric Hexagon

Information about standard products or non-standard products can be found in the current price list.
Dimensions shown may be changed at any time without prior notice.



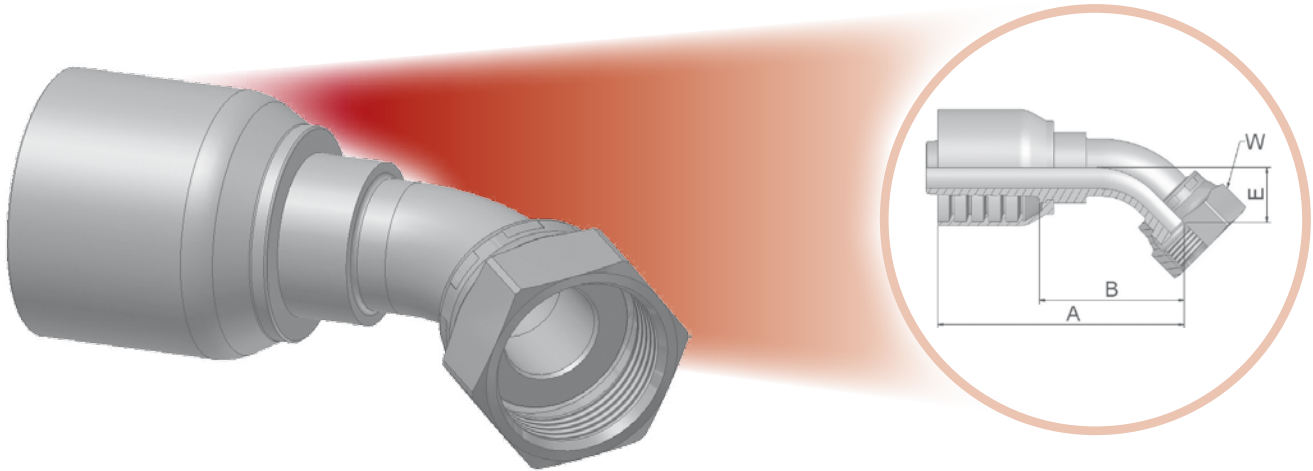

J7 - Female ORFS - Swivel - 45° Elbow - ISO 12151-1 - SWE 45°

ISO 12151-1-SWE45 - SAE J516 - ORFS 45°



Approved fitting series for hose types:



XXXX-XX-XX Part Number 	 Hose I.D.				 Thread UNF	A	B	E	 W
	DN	Inch	Size	mm					
1J771-6-6-SM	10	3/8	-6	9,5	11/16x16	62	33	11	22
1J771-8-8-SM	12	1/2	-8	12,7	13/16x16	72	37	15	24
1J771-10-8-SM	12	1/2	-8	12,7	1x14	81	46	17	30
1J771-12-10-SM	16	5/8	-10	15,9	1-3/16x12	90	53	21	36
1J771-12-12-SM	20	3/4	-12	19,1	1-3/16x12	92	53	21	36
1J771-16-12-SM	20	3/4	-12	19,1	1-7/16x12	95	56	24	41
1J771-16-16-SM	25	1	-16	25,4	1-7/16x12	112	66	24	41
1J771-20-20-SM	32	1-1/4	-20	31,8	1-11/16x12	130	82	27	50
1J771-24-24-SM	40	1-1/2	-24	38,1	2x12	169	109	40	60

Material: steel chromium(VI) free plated
SM: Metric Hexagon

Information about standard products or non-standard products can be found in the current price list.
Dimensions shown may be changed at any time without prior notice.



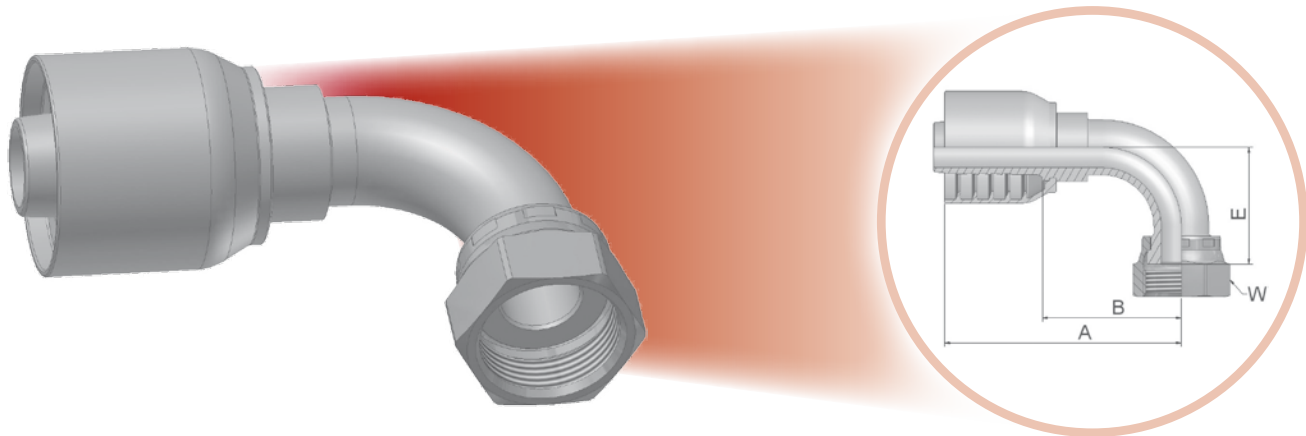

J9 - Female ORFS - Swivel - 90° Elbow - Short Drop

ISO 12151-1-SWES - SAE J516 - ORFS 90°



Approved fitting series for hose types:



XXXX-XX-XX Part Number 	 Hose I.D.				 Thread UNF	A	B	E	 W
	DN	Inch	Size	mm					
1J971-6-6-SM	10	3/8	-6	9,5	11/16x16	58	29	23	22
1J971-8-8-SM	12	1/2	-8	12,7	13/16x16	70	35	29	24
1J971-10-8-SM	12	1/2	-8	12,7	1x14	73	38	32	30
1J971-10-10-SM	16	5/8	-10	15,9	1x14	78	39	33	30
1J971-12-12-SM	20	3/4	-12	19,1	1-3/16x12	89	50	48	36
1J971-16-16-SM	25	1	-16	25,4	1-7/16x12	111	64	56	41
1J971-20-20-SM	32	1-1/4	-20	31,8	1-11/16x12	130	83	64	50
1J971-24-20-SM	32	1-1/4	-20	31,8	2x12	130	82	70	60

Material: steel chromium(VI) free plated
SM: Metric Hexagon

Information about standard products or non-standard products can be found in the current price list.
Dimensions shown may be changed at any time without prior notice.



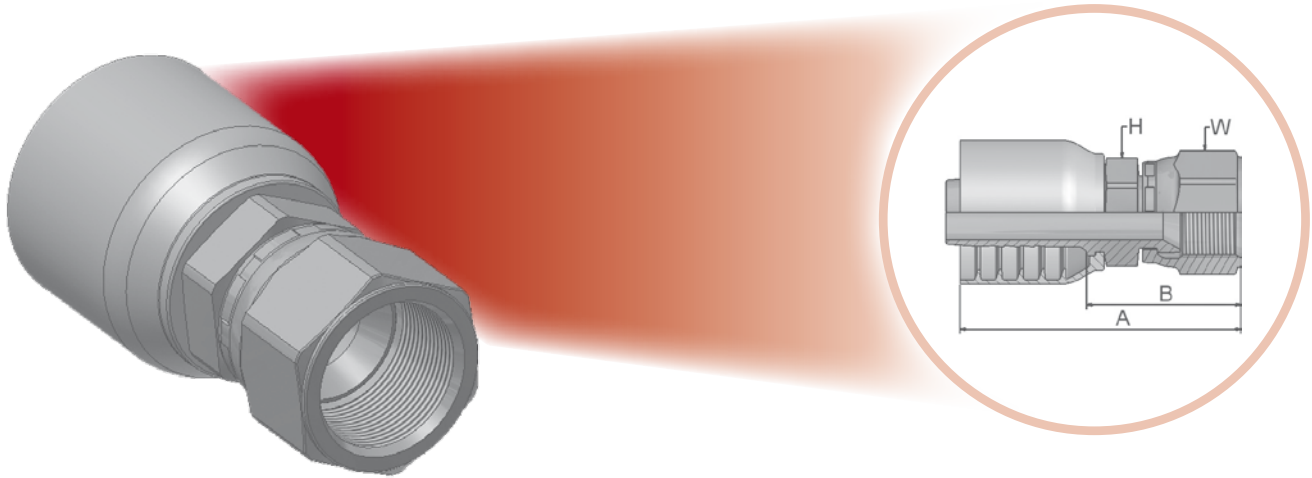

XU - Female Metric - Swivel - Straight (30° Flare)

JIS B 8363



Approved fitting series for hose types:













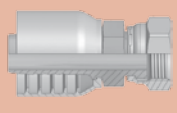
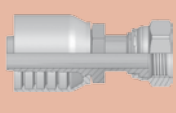
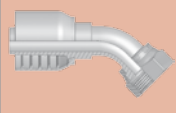
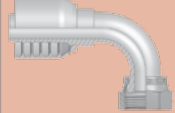

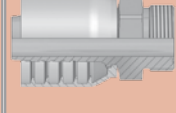

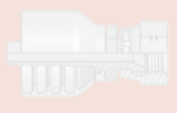



XXXX-XX-XX Part Number 	 Hose I.D.				 Thread metric	A	B	 H	 W
	DN	Inch	Size	mm					
1XU71-10-10	16	5/8	-10	15,9	M24x1,5	67	28	30	32
1XU71-12-12	20	3/4	-12	19,1	M30x1,5	68	28	36	36
1XU71-16-16	25	1	-16	25,4	M33x1,5	82	35	36	41
1XU71-20-20	32	1-1/4	-20	31,8	M36x1,5	106	64	46	46
1XU71-24-24	40	1-1/2	-24	38,1	M42x1,5	125	71	55	55













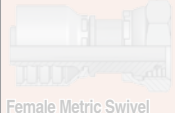



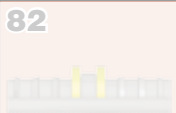

Material: steel chromium(VI) free plated

Information about standard products or non-standard products can be found in the current price list.
Dimensions shown may be changed at any time without prior notice.

Fittings Overview 73 Series

DIN	CA  DKOL	CE  DKOL 45°	CF  DKOL 90°	D0  CEL	C0  DKM or DKLL	C3  DKL	C4  DKL 45°	
	C5  DKL 90°	1D  BEL	DD  BEL 45°	5D  BEL 90°	C9 Dd-1  DKOS	0C Dd-2  DKOS 45°	1C Dd-3  DKOS 90°	
	D2 Dd-4  CES	C6  DKS	3D  BES	49  Metric Banjo	9B  Swivel Female 45° Elbow	9C  Swivel Female 90° Elbow		
BSP	92 Dd-5  DKR	B1 Dd-6  DKR 45°	B2 Dd-7  DKR 90°	B4  DKR 90° (Compact)	EA  DKOR	EB  DKOR 45°	EC  DKOR 90°	
	D9 Dd-8  AGR	91  AGR-K	B5  Female BSP Parallel Pipe - Swivel (Flat Seat)	34  Standpipe				
	SAE	01 Dd-9  AGN	02  Female NPTF Pipe Rigid - Straight	03 Dd-10  AGJ	04  Male SAE 45° - Rigid	05  Male SAE Straight Thread with O-ring - Rigid	06 Dd-11 68  DKJ	08  AGS
13  Male NPTF Pipe Swivel		33  Male JIC 37° - Rigid	37 Dd-12 3V  DKJ 45°	39 Dd-13 3W  DKJ 90°	41 3Y  DKJ 90° L	L9  DKJ 90° M	93  Female JIC 37° - Swivel (Block Type)	
Flange		15 Dd-14 4A  SFL	16  SFL 22.5°	17 Dd-15 4F  SFL 45°	19 Dd-16 4N  SFL 90°	6A Dd-17  SFS	6F Dd-18  SFS 45°	6N Dd-19  SFS 90°
	89  SFL 90° - long	XA  Caterpillar Flange Head	XF  Caterpillar Flange Head 45°	XG  Caterpillar Flange Head 60°	XN  Caterpillar Flange Head 90°			

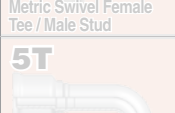
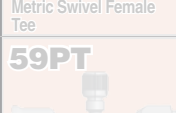
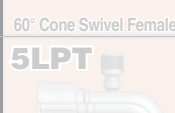
ORFS	JC Dd-20  ORFS - short	JS Dd-21  ORFS - long	J7 Dd-22  ORFS 45°	J9 Dd-23  ORFS Female 90°	J1  ORFS 90° - extra long	J5  ORFS 90° - long	JM Dd-24  ORFS Male
	JD  Male ORFS - Bulkhead with Locknut (with O-ring)						
JIS	FU  GUI	GU  GUO	MU  Female Metric Swivel - (30° Flare)	MZ  Female Metric Swivel - (30° Flare)	UT  Male BSP Taper Pipe Rigid - (60° Cone)		
	French Standard	FG  Male Rigid Gas Series - (24° Cone)	F2  Female Swivel Gas Series	F4  Female Swivel Gas Series - (Ball Nose)	F6  Male Metric (24° Cone)	F9  Swivel Female Metric (Ball Nose)	FA  Metric Male for Agriculture Valves
High Pressure Cleaning		CW  Power Cleaner Connection	PW  Male Kärcher Metric Cleaning Hose Fitting - Rigid	NW  Female Kärcher Metric Cleaning Hose Fitting Swivel - (New Design)			

others	XU  Female Metric Swivel - (30° Flare)	XY  Female Metric Swivel - (30° Flare)	DK  Male Metric L - Rigid Bulkhead with Locknut (24° Cone)	DX  Female Metric Swivel (M27x2) O-ring - Light Series	FF  Metru-Lok Swivel Female	AF  Male BSP Parallel Pipe Rigid - Straight (with O-ring Seal)	NM  Male BSP Parallel Pipe - L Series - Rigid Straight - ED-Seal
	YW  Male Standpipe - Rigid - Straight - A-Lok	VW121  BSP Swivel Female	82  Push-Lok Union	DP  Metric Swivel Female Tee / Male Stud	DR  Metric Swivel Female Tee	5C  60° Cone Swivel Female	6C  60° Cone Swivel Female - 45° Elbow
	7C  60° Cone Swivel Female - 90° Elbow	5S  Female Tube O-ring Swivel - Short Pilot	5H  Female Tube O-ring Swivel - 45° Elbow Short Pilot	5T  Female Tube O-ring Swivel 90° Elbow Short Pilot	59PT  Male Tube O-ring Swivel - Long Pilot Charge Port at 180° for R134a	5LPT  Female Tube O-ring Swivel - 90° Elbow Long Pilot Charge Port at 180° for R134a	T1  Male Refrigerant Tube Mender - Straight (with Nut and Ferrule)



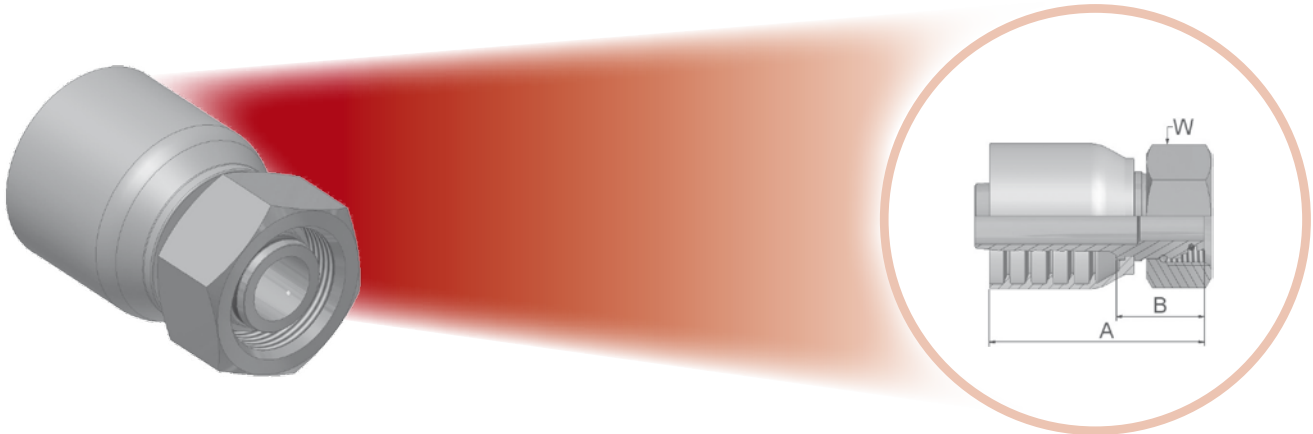

C9 – Female Metric 24° – Heavy Series with O-ring – Swivel – Straight

ISO 12151-2-SWS-S – DKOS



Approved fitting series for hose types:



XXXX-XX-XX Part Number 	 Hose I.D.				 Thread metric	Tube O.D.	A	B	 W
	DN	Inch	Size	mm					
1C973-20-12	20	3/4	-12	19,1	M30x2	20	81	33	36
1C973-25-12	20	3/4	-12	19,1	M36x2	25	80	32	46
1C973-20-16	25	1	-16	25,4	M30x2	20	86	36	36
1C973-25-16	25	1	-16	25,4	M36x2	25	87	36	46
1C973-30-16	25	1	-16	25,4	M42x2	30	87	36	50
1C973-30-20	32	1-1/4	-20	31,8	M42x2	30	106	42	50
1C973-38-20	32	1-1/4	-20	31,8	M52x2	38	102	35	60
1C973-38-24	40	1-1/2	-24	38,1	M52x2	38	105	42	60

Fittings with standard O-ring seals can be used for temperatures from -30 °C up to +105 °C.
 Find O-rings in section E. Special O-rings are available on request.
 Material: steel chromium(VI) free plated

Information about standard products or non-standard products can be found in the current price list.
 Dimensions shown may be changed at any time without prior notice.

OC – Female Metric 24° – Heavy Series with O-ring – Swivel – 45° Elbow

ISO 12151-2-SWE45-S – DKOS 45°

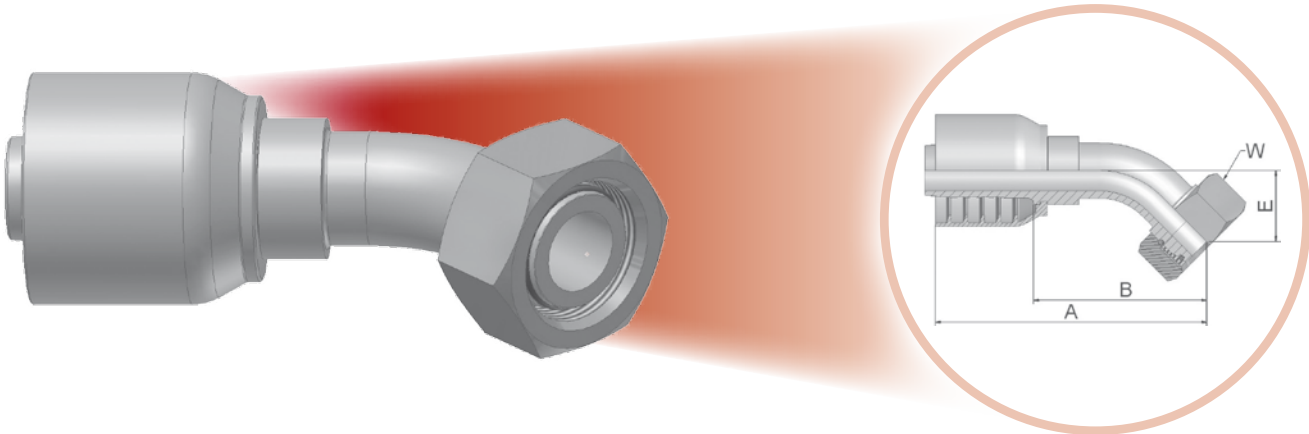

Approved fitting series for hose types:



XXXX-XX-XX Part Number 	Hose I.D.				Thread metric	Tube O.D.	A	B	E	W
	DN	Inch	Size	mm						
10C73-20-12	20	3/4	-12	19,1	M30x2	20	112	64	28	36
10C73-25-12	20	3/4	-12	19,1	M36x2	25	113	65	29	46
10C73-30-16	25	1	-16	25,4	M42x2	30	131	81	34	50
10C73-38-20	32	1-1/4	-20	31,8	M52x2	38	161	97	37	60

Fittings with standard O-ring seals can be used for temperatures from -30 °C up to +105 °C.
Find O-rings in section E. Special O-rings are available on request.
Material: steel chromium(VI) free plated

Information about standard products or non-standard products can be found in the current price list.
Dimensions shown may be changed at any time without prior notice.



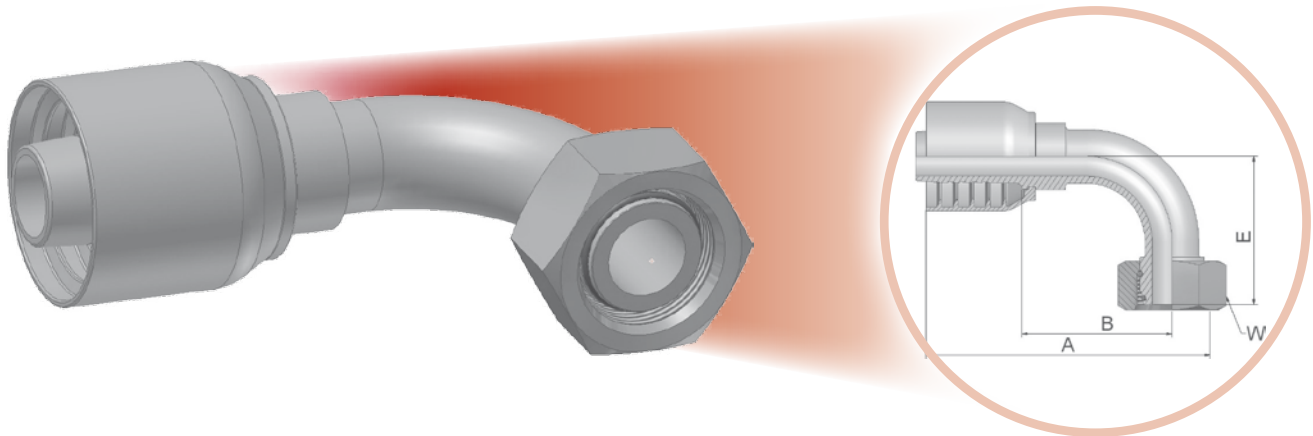

1C – Female Metric 24° – Heavy Series with O-ring – Swivel – 90° Elbow

ISO 12151-2-SWE-S – DKOS 90°



Approved fitting series for hose types:



XXXX-XX-XX Part Number 	 Hose I.D.				 Thread metric	Tube O.D.	A	B	E	 W
	DN	Inch	Size	mm						
11C73-20-12	20	3/4	-12	19,1	M30x2	20	101	53	57	36
11C73-25-12	20	3/4	-12	19,1	M36x2	25	101	52	59	46
11C73-25-16	25	1	-16	25,4	M36x2	25	122	71	70	46
11C73-30-16	25	1	-16	25,4	M42x2	30	122	72	73	50
11C73-30-20	32	1-1/4	-20	31,8	M42x2	30	138	73	74	50
11C73-38-20	32	1-1/4	-20	31,8	M52x2	38	151	87	78	60

Fittings with standard O-ring seals can be used for temperatures from -30 °C up to +105 °C.
Find O-rings in section E. Special O-rings are available on request.
Material: steel chromium(VI) free plated

Information about standard products or non-standard products can be found in the current price list.
Dimensions shown may be changed at any time without prior notice.





D2 – Male Metric 24° – Heavy Series – Rigid – Straight

ISO 12151-2-S-S – CES



Approved fitting series for hose types:



XXXX.XX.XX Part Number 	 Hose I.D.				 Thread metric	Tube O.D.	A	B	 H
	DN	Inch	Size	mm					
1D273-20-12	20	3/4	-12	19,1	M30x2	20	84	35	30
1D273-25-12	20	3/4	-12	19,1	M36x2	25	86	37	36
1D273-30-16	25	1	-16	25,4	M42x2	30	94	42	46
1D273-38-20	32	1-1/4	-20	31,8	M52x2	38	112	46	55

Material: steel chromium(VI) free plated

Information about standard products or non-standard products can be found in the current price list. Dimensions shown may be changed at any time without prior notice.





92 - Female BSP Parallel Pipe – Swivel – Straight (60° Cone)

BS5200-A – DKR



Approved fitting series for hose types:



XXXX-XX-XX Part Number 	 Hose I.D.				 Thread BSP	A mm	B mm	 W mm
	DN	Inch	Size	mm				
19273-12-12	20	3/4	-12	19,1	3/4x14	77	29	32
19273-16-16	25	1	-16	25,4	1x11	89	38	41
19273-20-20	32	1-1/4	-20	31,8	1-1/4x11	101	37	50
19273-24-24	40	1-1/2	-24	38,1	1-1/2x11	100	37	55
19273-32-32	50	2	-32	50,8	2x11	113	38	70

Material: steel chromium(VI) free plated

Information about standard products or non-standard products can be found in the current price list.
Dimensions shown may be changed at any time without prior notice.



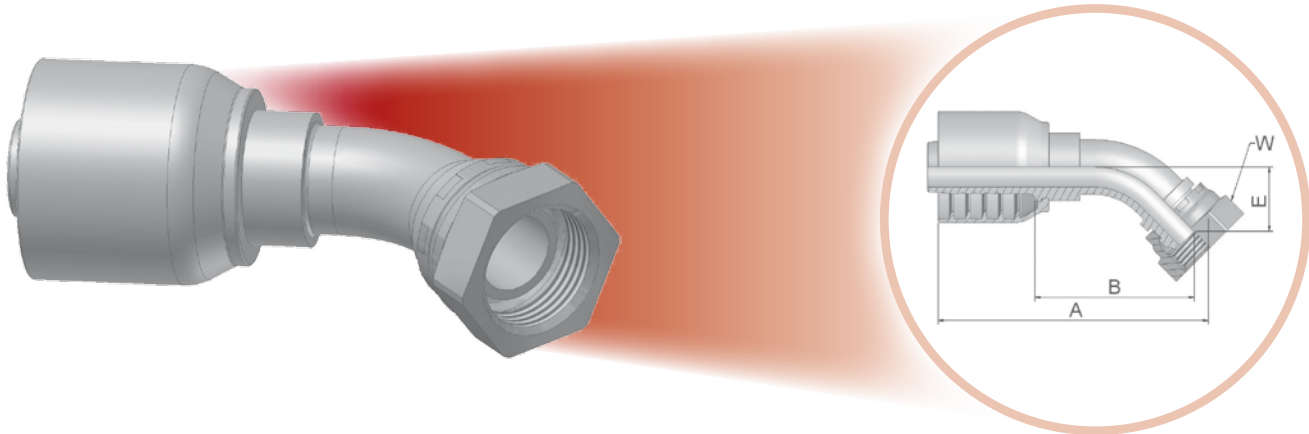

B1 - Female BSP Parallel Pipe - Swivel - 45° Elbow (60° Cone)

BS 5200-D - DKR 45°



Approved fitting series for hose types:



XXXX.XX.XX Part Number 	 Hose I.D.				 Thread BSP	A	B	E	 W
	DN	Inch	Size	mm		mm	mm	mm	mm
1B173-12-12	20	3/4	-12	19,1	3/4x14	110	62	26	32
1B173-16-16	25	1	-16	25,4	1x11	136	84	39	41
1B173-20-20	32	1-1/4	-20	31,8	1-1/4x11	169	105	44	50
1B173-24-24	40	1-1/2	-24	38,1	1-1/2x11	172	109	38	55
1B173-32-32	50	2	-32	50,8	2x11	229	157	50	70

Material: steel chromium(VI) free plated

Information about standard products or non-standard products can be found in the current price list.
Dimensions shown may be changed at any time without prior notice.



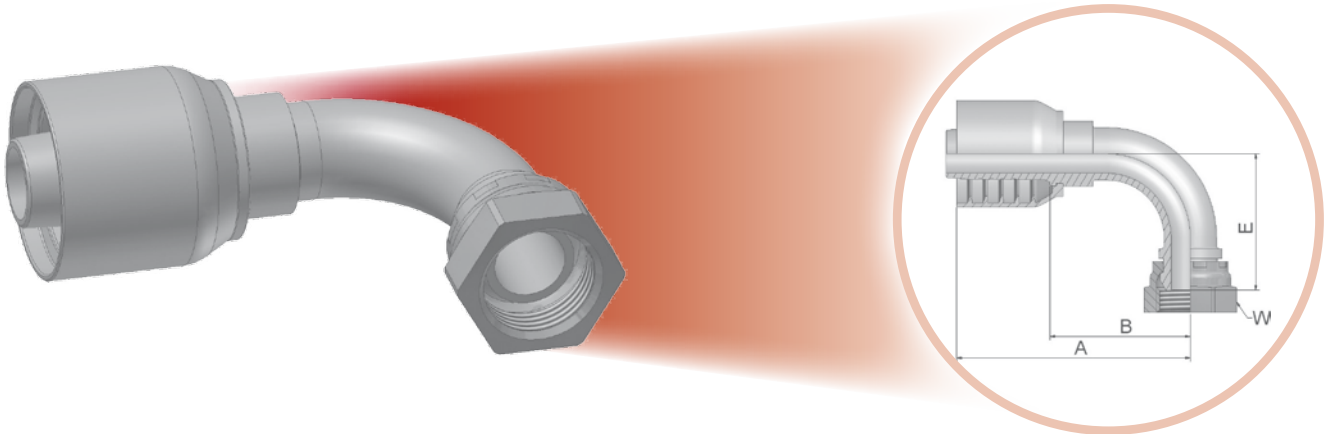

B2 – Female BSP Parallel Pipe – Swivel – 90° Elbow (60° Cone)

BS 5200-B – DKR 90°



Approved fitting series for hose types:



XXXX-XX-XX Part Number 	 Hose I.D.				 Thread BSP	A	B	E	 W
	DN	Inch	Size	mm					
1B273-12-12	20	3/4	-12	19,1	3/4x14	106	58	55	32
1B273-16-16	25	1	-16	25,4	1x11	121	70	76	41
1B273-20-20	32	1-1/4	-20	31,8	1-1/4x11	151	87	80	50
1B273-24-24	40	1-1/2	-24	38,1	1-1/2x11	166	103	103	55
1B273-32-32	50	2	-32	50,8	2x11	229	157	149	70

Material: steel chromium(VI) free plated

Information about standard products or non-standard products can be found in the current price list.
Dimensions shown may be changed at any time without prior notice.



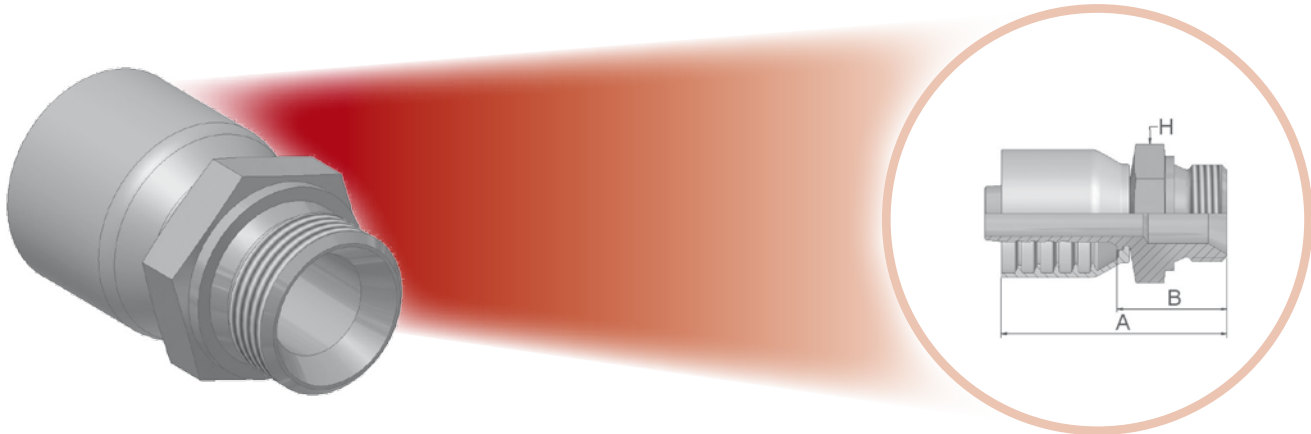

D9 – Male BSP Parallel Pipe – Rigid – Straight (60° Cone)

BS5200 – AGR



Approved fitting series for hose types:



XXXX-XX-XX Part Number 	 Hose I.D.				 Thread BSP	A	B	 H
	DN	Inch	Size	mm				
1D973-12-12	20	3/4	-12	19,1	3/4x14	87	38	32
1D973-16-16	25	1	-16	25,4	1x11	95	43	41
1D973-20-20	32	1-1/4	-20	31,8	1-1/14x11	114	47	50
1D973-24-24	40	1-1/2	-24	38,1	1-1/2x11	114	49	55
1D973-32-32	50	2	-32	50,8	2x11	129	58	70

Material: steel chromium(VI) free plated

Information about standard products or non-standard products can be found in the current price list.
Dimensions shown may be changed at any time without prior notice.



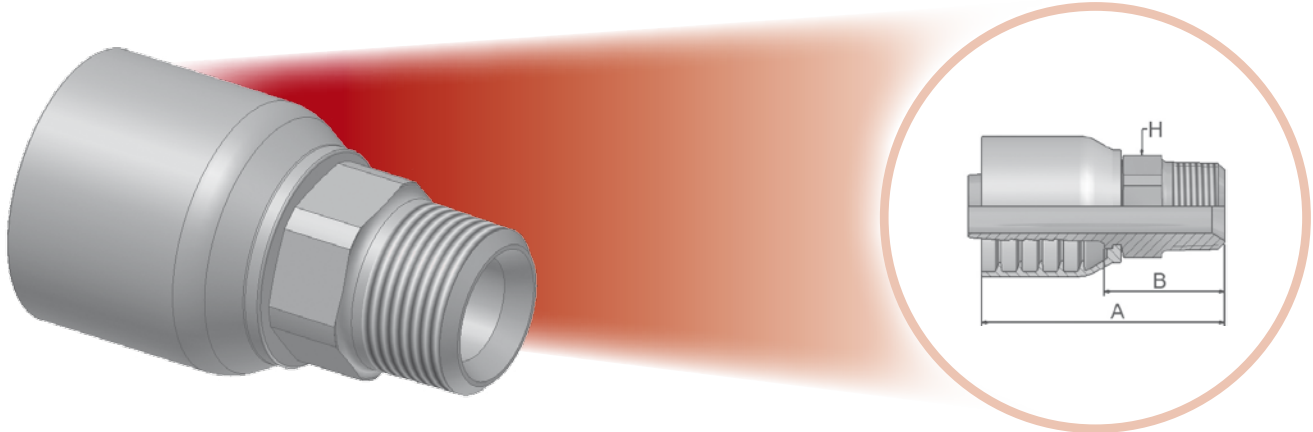

01 - Male NPTF Pipe - Rigid - Straight

SAE J476A - J516 - AGN



Approved fitting series for hose types:



XXXX-XX-XX Part Number 	 Hose I.D.				 Thread NPTF	A	B	 H
	DN	Inch	Size	mm		mm	mm	mm / Inch
10173-12-12-SM	20	3/4	-12	19,1	3/4x14	90	42	30
10173-16-16	25	1	-16	25,4	1x11-1/2	100	51	1-3/8
10173-20-20-SM	32	1.1/4	-20	31,8	1-1/4x11-1/2	125	61	46
10173-24-24-SM	40	1-1/2	-24	38,1	1-1/2x11-1/2	124	61	50
10173-32-32	50	2	-32	50,8	2x11-1/2	141	73	2-1/2

Material: steel chromium(VI) free plated

Information about standard products or non-standard products can be found in the current price list.
Dimensions shown may be changed at any time without prior notice.



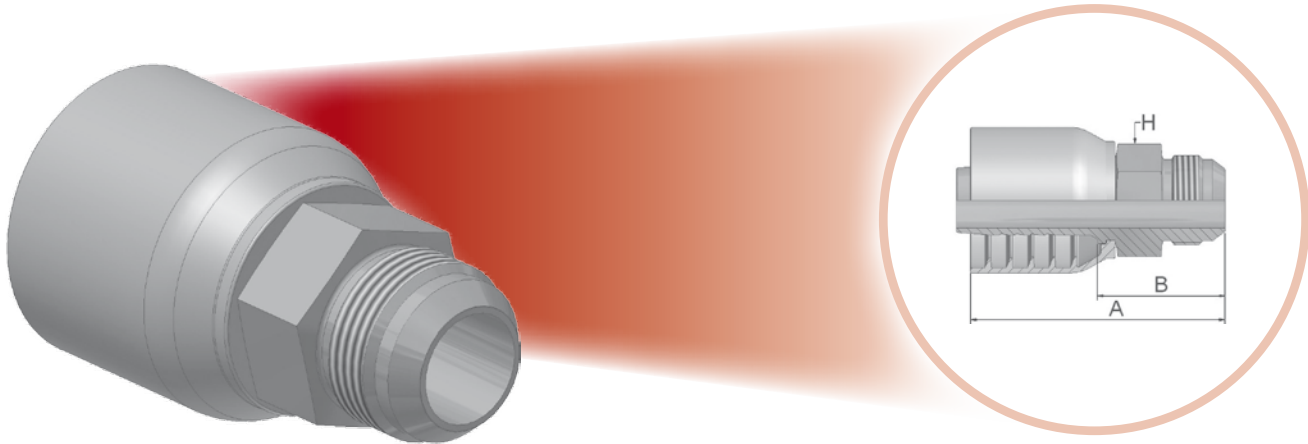

03 - Male JIC 37° - Rigid - Straight

ISO12151-5-S - AGJ



Approved fitting series for hose types:



XXXX-XX-XX Part Number 	 Hose I.D.				 Thread UNF	A mm	B mm	 H mm / Inch
	DN	Inch	Size	mm				
10373-12-12-SM	20	3/4	-12	19,1	1-1/16x12	89	41	30
10373-16-12-SM	20	3/4	-12	19,1	1-5/16x12	91	43	36
10373-16-16-SM	25	1	-16	25,4	1-5/16x12	97	47	36
10373-20-16	25	1	-16	25,4	1-5/8x12	102	52	46
10373-20-20-SM	32	1-1/4	-20	31,8	1-5/8x12	118	54	46
10373-24-20	32	1-1/4	-20	31,8	1-7/8x12	118	54	2"
10373-24-24-SM	40	1-1/2	-24	38,1	1-7/8x12	122	59	50
10373-32-32-SM	50	2	-32	50,8	2-1/2x12	143	72	65

Material: steel chromium(VI) free plated
SM: Metric Hexagon

Information about standard products or non-standard products can be found in the current price list.
Dimensions shown may be changed at any time without prior notice.



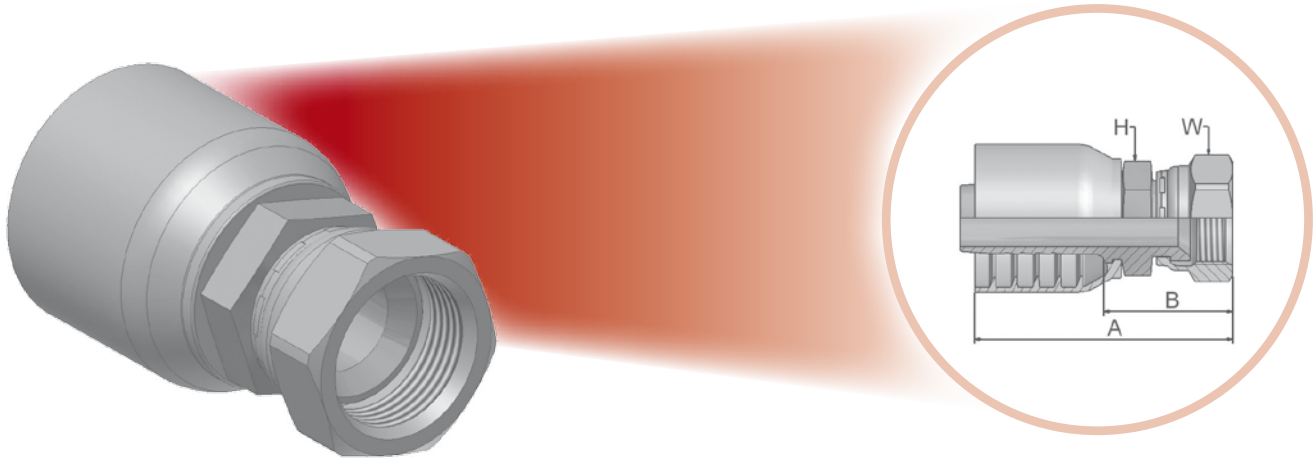

06 – Female JIC 37° Swivel – Straight

ISO12151-5-SWS – DKJ



Approved fitting series for hose types:



XXXX-XX-XX Part Number 	 Hose I.D.				 Thread UNF	A	B	 H	 W
	DN	Inch	Size	mm					
10673-12-12-SM	20	3/4	-12	19,1	1-1/16x12	93	45	30	32
10673-16-12	20	3/4	-12	19,1	1-5/16x12	95	47	1-3/8	1-1/2
10673-16-16-SM	25	1	-16	25,4	1-5/16x12	103	52	36	41
10673-20-16	25	1	-16	25,4	1-5/8x12	108	60	1-3/4	2"
10673-20-20-SM	32	1-1/4	-20	31,8	1-5/8x12	125	61	46	55
10673-24-20-SM	32	1-1/4	-20	31,8	1-7/8x12	130	66	50	60
10673-24-24-SM	40	1-1/2	-24	38,1	1-7/8x12	128	66	50	60
10673-32-32	50	2	-32	50,8	2-1/2x12	150	81	2-1/2	2-7/8

Material: steel chromium(VI) free plated
SM: Metric Hexagon

Information about standard products or non-standard products can be found in the current price list.
Dimensions shown may be changed at any time without prior notice.



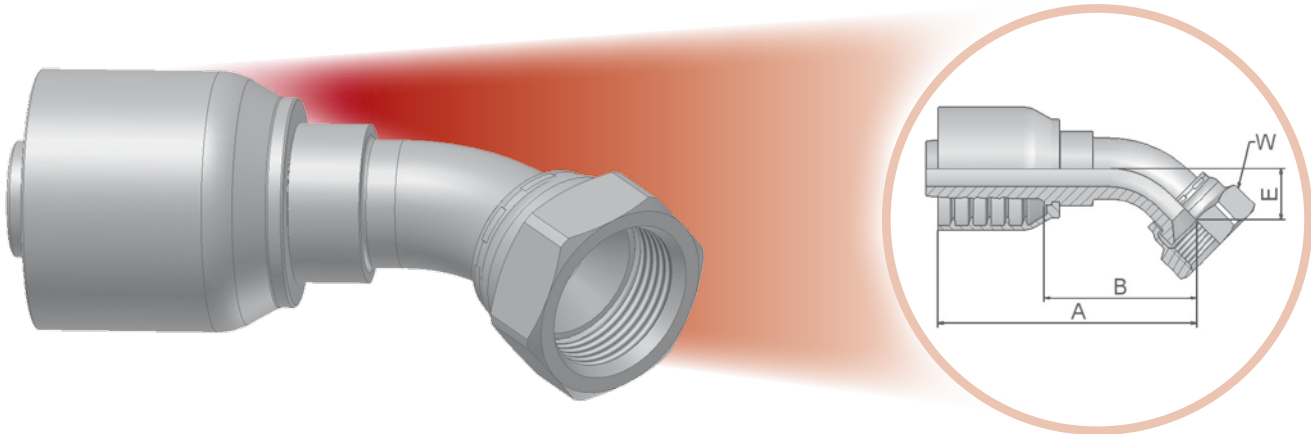

37 - Female JIC 37° - Swivel - 45° Elbow

ISO 12151-5-SWE45 - DKJ 45°



Approved fitting series for hose types:



XXXX.XX.XX Part Number 	 Hose I.D.				 Thread UNF	A	B	E	 W
	DN	Inch	Size	mm		mm	mm	mm	mm
13773-12-12-SM	20	3/4	-12	19,1	1-1/16x12	104	56	21	32
13773-16-16-SM	25	1	-16	25,4	1-5/16x12	119	69	24	41
13773-20-20-SM	32	1-1/4	-20	31,8	1-5/8x12	172	108	47	55
13773-24-24-SM	40	1-1/2	-24	38,1	1-7/8x12	194	132	58	60
13773-32-32-SM	50	2	-32	50,8	2-1/2x12	251	179	72	75

Material: steel chromium(VI) free plated
SM: Metric Hexagon

Information about standard products or non-standard products can be found in the current price list.
Dimensions shown may be changed at any time without prior notice.



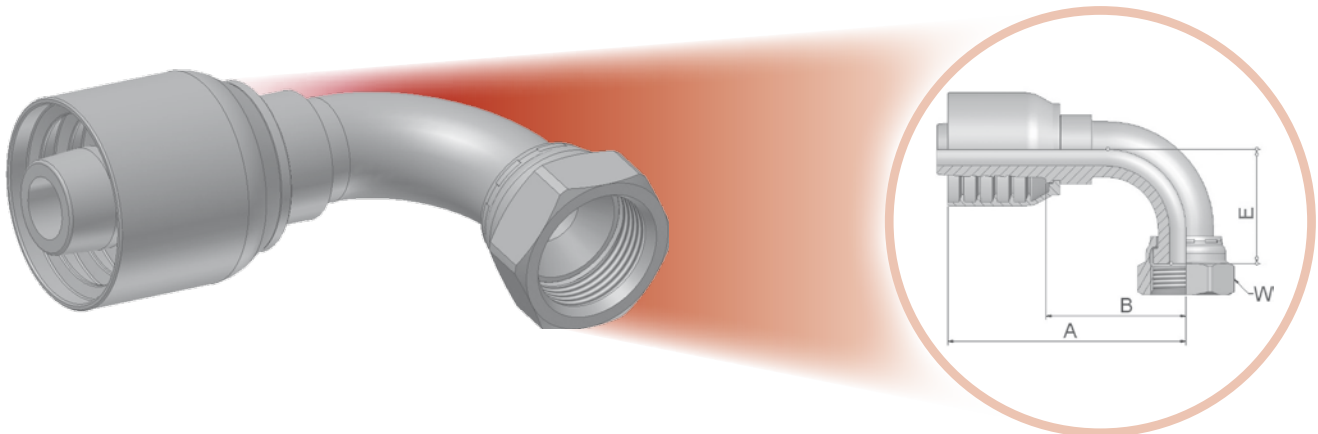

39 - Female JIC 37° - Swivel - 90° Elbow

ISO 12151-5-SWES – DKJ 90°



Approved fitting series for hose types:



XXXX-XX-XX Part Number 	 Hose I.D.				 Thread UNF	A	B	E	 W
	DN	Inch	Size	mm		mm	mm	mm	mm / Inch
13973-12-12	20	3/4	-12	19,1	1-1/16x12	103	59	62	1-1/2
13973-16-12	20	3/4	-12	19,1	1-5/16x12	115	94	41	1-1/2
13973-16-16-SM	25	1	-16	25,4	1-5/16x12	118	67	56	41
13973-20-20-SM	32	1.1/4	-20	31,8	1-5/8x12	151	87	85	55
13973-24-24-SM	40	1-1/2	-24	38,1	1-7/8x12	194	119	102	60
13973-32-32-SM	50	2	-32	50,8	2-1/2x12	229	157	152	75

Material: steel chromium(VI) free plated
SM: Metric Hexagon

Information about standard products or non-standard products can be found in the current price list.
Dimensions shown may be changed at any time without prior notice.

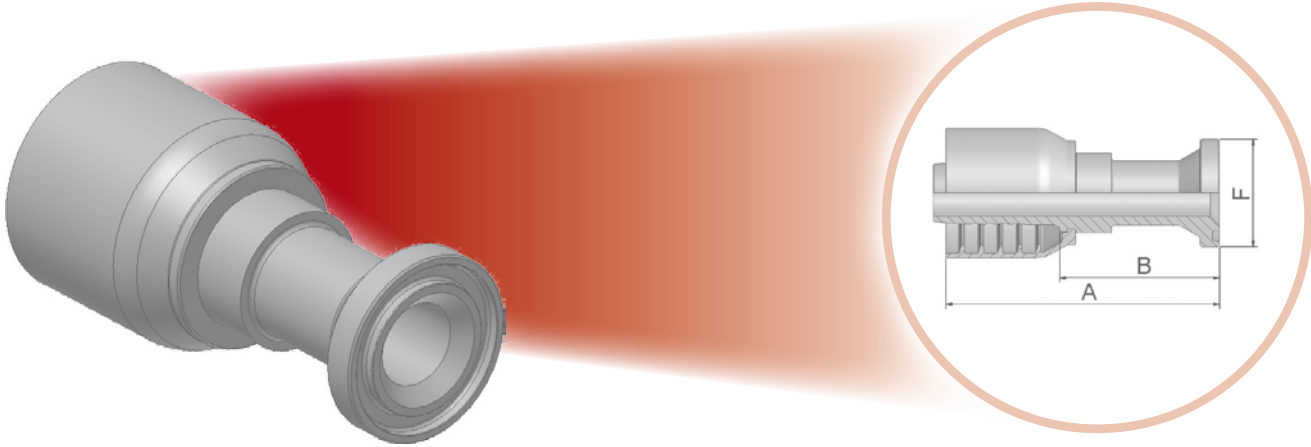

15/4A – SAE Code 61 – Flange Head – Straight (5000 psi)

ISO 12151-3-SL – SFL



Approved fitting series for hose types:



XXXX-XX-XX Part Number 	 Hose I.D.				 End Connection	A	B	F
	DN	Inch	Size	mm				
11573-12-12	20	3/4	-12	19,1	3/4	110	62	38
11573-16-12	20	3/4	-12	19,1	1	110	62	45
11573-16-16	25	1	-16	25,4	1	117	67	45
11573-16-20	32	1-1/4	-20	31,8	1	133	69	45
14A73-20-16	25	1	-16	25,4	1-1/4	85	34	51
14A73-20-20	32	1-1/4	-20	31,8	1-1/4	141	77	51
14A73-24-20	32	1-1/4	-20	31,8	1-1/2	104	40	60
14A73-24-24	40	1-1/2	-24	38,1	1-1/2	166	103	60
14A73-32-24	40	1-1/2	-24	38,1	2	113	50	71
14A73-32-32	50	2	-32	50,8	2	220	148	71

Find SAE flange halves in section Eb.

Fittings with standard O-ring seals can be used for temperatures from -30 °C up to +105 °C.

Find O-rings in section E. Special O-rings are available on request.

Material: steel chromium(VI) free plated

Information about standard products or non-standard products can be found in the current price list.
Dimensions shown may be changed at any time without prior notice.

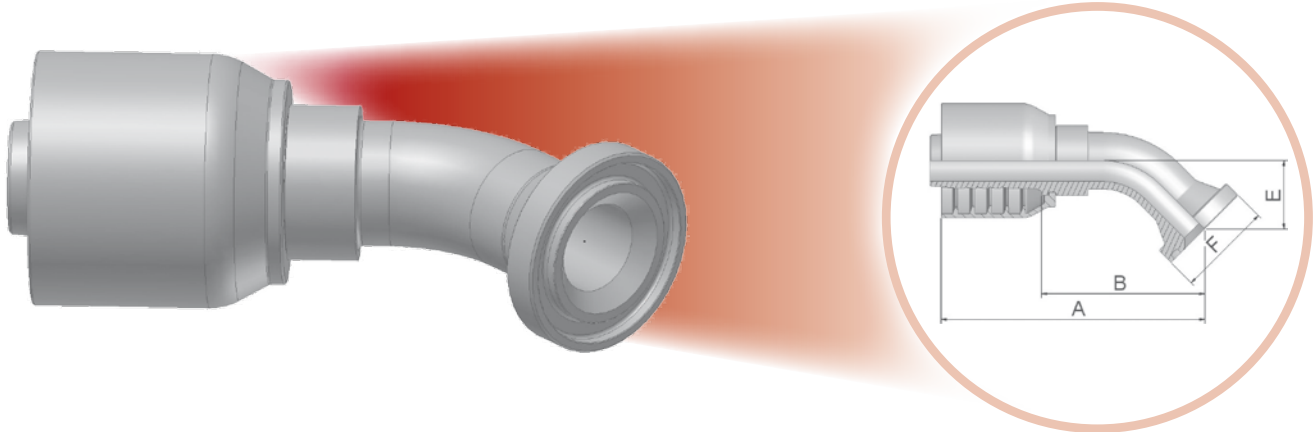

17/4F – SAE Code 61 – Flange Head 45° Elbow – 45° Elbow (5000 psi)

ISO 12151-3-E45S-L – SFL 45°



Approved fitting series for hose types:



XXXX-XX-XX Part Number 	Hose I.D. 				End Connection 	A	B	E	F
	DN	Inch	Size	mm					
11773-12-12	20	3/4	-12	19,1	3/4	119	71	27	38
11773-16-12	20	3/4	-12	19,1	1	109	64	26	44
11773-16-16	25	1	-16	25,4	1	127	77	32	45
14F73-20-16	25	1	-16	25,4	1-1/4	136	85	32	51
14F73-20-20	32	1-1/4	-20	31,8	1-1/4	160	96	35	51
14F73-24-20	32	1-1/4	-20	31,8	1-1/2	162	102	38	60
14F73-24-24	40	1-1/2	-24	38,1	1-1/2	178	115	44	60
14F73-32-32	50	2	-32	50,8	2	224	153	62	71

Find SAE flange halves in section Eb.
Fittings with standard O-ring seals can be used for temperatures from -30 °C up to +105 °C.
Find O-rings in section E. Special O-rings are available on request.
Material: steel chromium(VI) free plated

Information about standard products or non-standard products can be found in the current price list.
Dimensions shown may be changed at any time without prior notice.

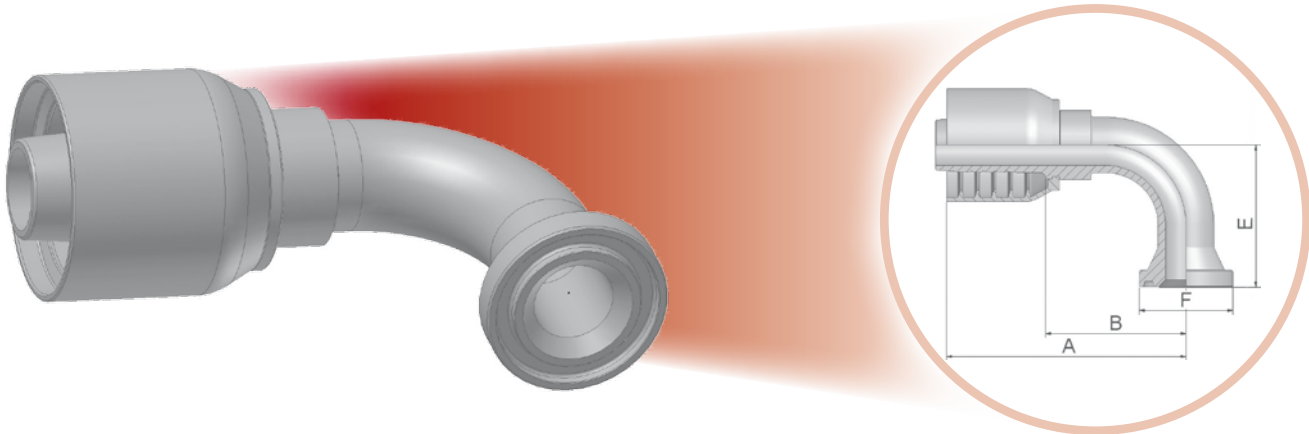

19/4N – SAE Code 61 – Flange Head – 90° Elbow (5000 psi)

ISO 12151-3-E90ML – SFL 90°



Approved fitting series for hose types:



XXXX-XX-XX Part Number 	 Hose I.D.				 End Connection	A	B	E	F
	DN	Inch	Size	mm					
11973-12-12	20	3/4	-12	19,1	3/4	109	61	58	38
11973-16-12	20	3/4	-12	19,1	1	102	54	58	45
11973-16-16	25	1	-16	25,4	1	118	67	70	45
14N73-20-16	25	1	-16	25,4	1-1/4	128	78	68	51
14N73-20-20	32	1-1/4	-20	31,8	1-1/4	155	91	90	51
14N73-24-20	32	1-1/4	-20	31,8	1-1/2	155	91	90	60
14N73-24-24	40	1-1/2	-24	38,1	1-1/2	166	103	93	60
14N73-32-24	40	1-1/2	-24	38,1	2	166	103	92	71
14N73-32-32	50	2	-32	50,8	2	220	148	133	71

Find SAE flange halves in section Eb.

Fittings with standard O-ring seals can be used for temperatures from -30 °C up to +105 °C.

Find O-rings in section E. Special O-rings are available on request.

Material: steel chromium(VI) free plated

Information about standard products or non-standard products can be found in the current price list.
Dimensions shown may be changed at any time without prior notice.

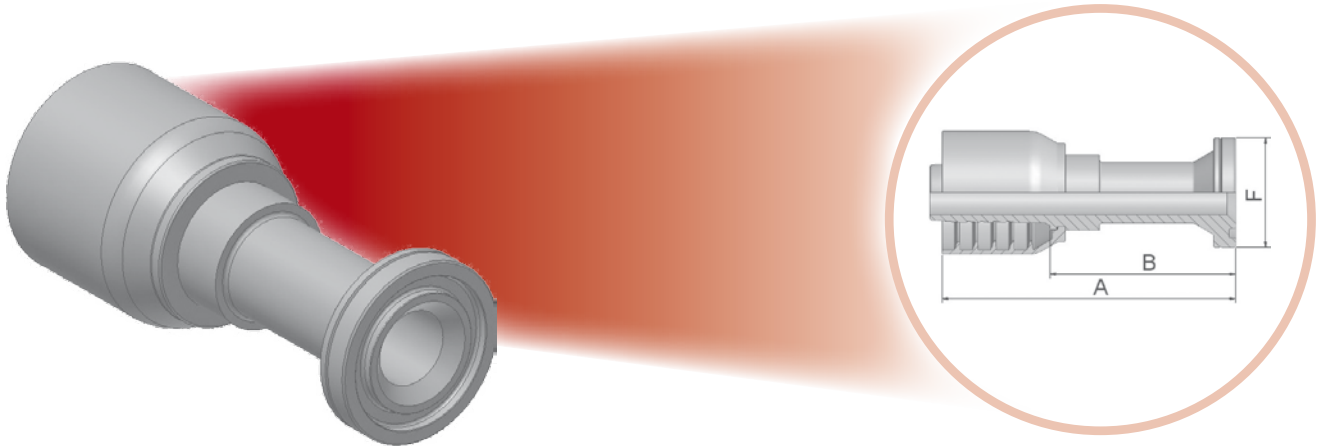

6A – SAE Code 62 – Flange – Straight

ISO 12151-3-S-S – SFS – 6000 psi



Approved fitting series for hose types:



XXXX.XX.XX Part Number 	 Hose I.D.				 End Connection	A	B	F
	DN	Inch	Size	mm				
16A73-12-12	20	3/4	-12	19,1	3/4	130	82	41
16A73-16-12	20	3/4	-12	19,1	1	135	87	48
16A73-12-16	25	1	-16	25,4	3/4	136	85	41
16A73-16-16	25	1	-16	25,4	1	131	81	48
16A73-20-16	25	1	-16	25,4	1-1/4	142	91	54
16A73-16-20	32	1-1/4	-20	31,8	1	149	85	48
16A73-20-20	32	1-1/4	-20	31,8	1-1/4	149	85	54
16A73-24-20	32	1-1/4	-20	31,8	1-1/2	121	57	64
16A73-20-24	40	1-1/2	-24	38,1	1-1/4	158	96	54
16A73-24-24	40	1-1/2	-24	38,1	1-1/2	166	104	64
16A73-32-24	40	1-1/2	-24	38,1	2	129	66	79
16A73-32-32	50	2	-32	50,8	2	194	122	79

Find SAE flange halves in section Eb.
 Fittings with standard O-ring seals can be used for temperatures from -30 °C up to +105 °C.
 Find O-rings in section E. Special O-rings are available on request.
 Material: steel chromium(VI) free plated

Information about standard products or non-standard products can be found in the current price list.
 Dimensions shown may be changed at any time without prior notice.

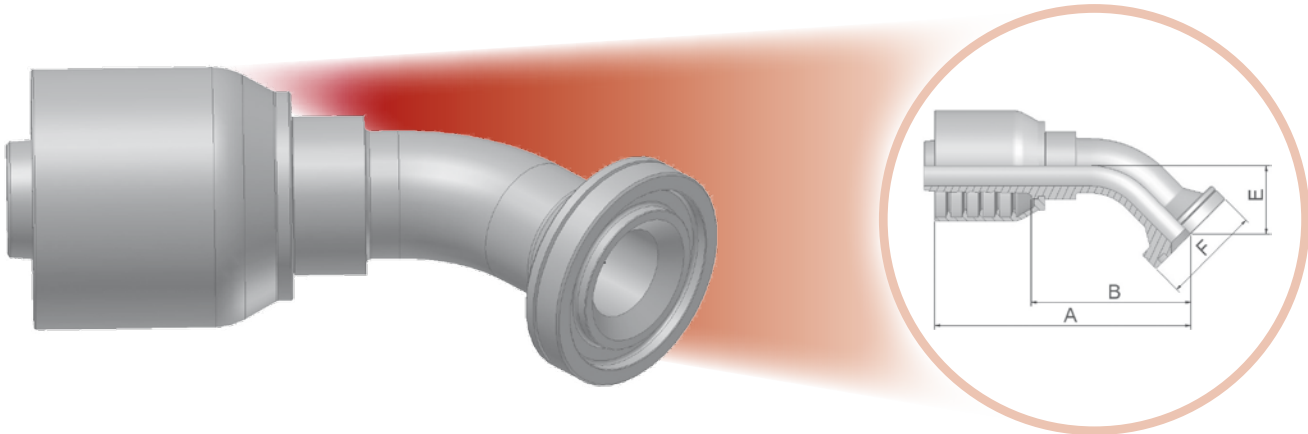

6F – SAE Flange 45° Elbow – Heavy Series

ISO 12151-3-E45-S – SFS 45° – 6000 psi



Approved fitting series for hose types:



XXXX.XX.XX Part Number 	 Hose I.D.				 End Connection	A	B	E	F
	DN	Inch	Size	mm					
16F73-12-12	20	3/4	-12	19,1	3/4	110	62	26	41
16F73-16-12	20	3/4	-12	19,1	1	110	62	26	48
16F73-12-16	25	1	-1	25,4	3/4	123	73	32	41
16F73-16-16	25	1	-16	25,4	1	129	79	32	48
16F73-20-16	25	1	-16	25,4	1-1/4	129	79	32	54
16F73-20-20	32	1-1/4	-20	31,8	1-1/4	163	98	38	54
16F73-24-20	32	1-1/4	-20	31,8	1-1/2	163	99	38	63
16F73-24-24	40	1-1/2	-24	38,1	1-1/2	178	115	44	64
16F73-32-32	50	2	-32	50,8	2	230	158	56	79

Find SAE flange halves in section Eb.

Fittings with standard O-ring seals can be used for temperatures from -30 °C up to +105 °C.

Find O-rings in section E. Special O-rings are available on request.

Material: steel chromium(VI) free plated

Information about standard products or non-standard products can be found in the current price list.
Dimensions shown may be changed at any time without prior notice.

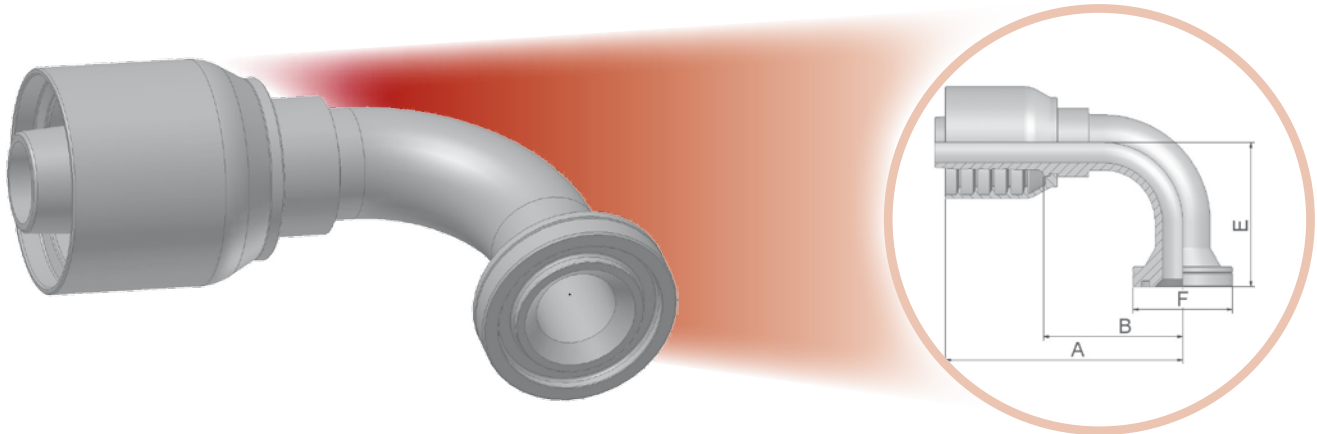

6N – SAE Code 62 Flange Head – 90° Elbow

ISO 12151-3-E90S-S – SFS 90°



Approved fitting series for hose types:



XXXX-XX-XX Part Number 	 Hose I.D.				 End Connection	A	B	E	F
	DN	Inch	Size	mm					
16N73-12-12	20	3/4	-12	19,1	3/4	101	53	58	41
16N73-12-16	25	1	-16	25,4	3/4	109	58	70	41
16N73-16-16	25	1	-16	25,4	1	122	71	70	48
16N73-20-16	25	1	-16	25,4	1-1/4	122	71	70	54
16N73-20-20	32	1-1/4	-20	31,8	1-1/4	172	108	71	54
16N73-24-20	32	1-1/4	-20	31,8	1-1/2	172	108	76	64
16N73-24-24	40	1-1/2	-24	38,1	1-1/2	166	103	104	64
16N73-32-32	50	2	-32	50,8	2	229	157	138	79

Find SAE flange halves in section Eb.
 Fittings with standard O-ring seals can be used for temperatures from -30 °C up to +105 °C.
 Find O-rings in section E. Special O-rings are available on request.
 Material: steel chromium(VI) free plated

Information about standard products or non-standard products can be found in the current price list.
 Dimensions shown may be changed at any time without prior notice.





JC – Female ORFS – Swivel – Straight – Short

ISO 12151-1-SWSA – SAE J516 – ORFS



Approved fitting series for hose types:



XXXX.XX.XX Part Number 	 Hose I.D.				 Thread UNF	A	B	 H	 W
	DN	Inch	Size	mm		mm	mm	mm	mm
1JC73-12-12-SM	20	3/4	-12	19,1	1-3/16x12	81	33	30	36

Material: steel chromium(VI) free plated
SM: Metric Hexagon

Information about standard products or non-standard products can be found in the current price list.
Dimensions shown may be changed at any time without prior notice.



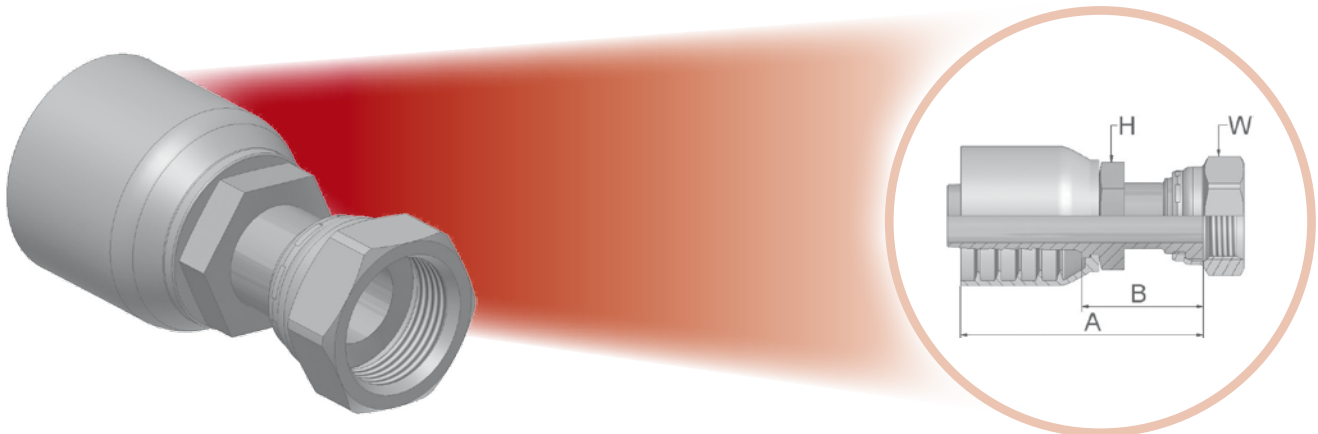

JS - ORFS Swivel Female (Long)

ISO 12151-1-SWSB – SAE J516 – ORFS



Approved fitting series for hose types:



XXXX-XX-XX Part Number 	 Hose I.D.				 Thread UNF	A	B	 H	 W
	DN	Inch	Size	mm		mm	mm	mm	mm
1JS73-12-12-SM	20	3/4	-12	19,1	1-3/16x12	98	50	30	36
1JS73-16-12-SM	20	3/4	-12	19,1	1-7/16x12	107	58	36	41
1JS73-16-16-SM	25	1	-16	25,4	1-7/16x12	103	52	36	41
1JS73-20-16-SM	25	1	-16	25,4	1-11/16x12	114	64	41	50
1JS73-20-20-SM	32	1.1/4	-20	31,8	1-11/16x12	118	54	46	50
1JS73-24-24-SM	40	1-1/2	-24	38,1	2x12	120	57	50	60

Material: steel chromium(VI) free plated
SM: Metric Hexagon

Information about standard products or non-standard products can be found in the current price list.
Dimensions shown may be changed at any time without prior notice.



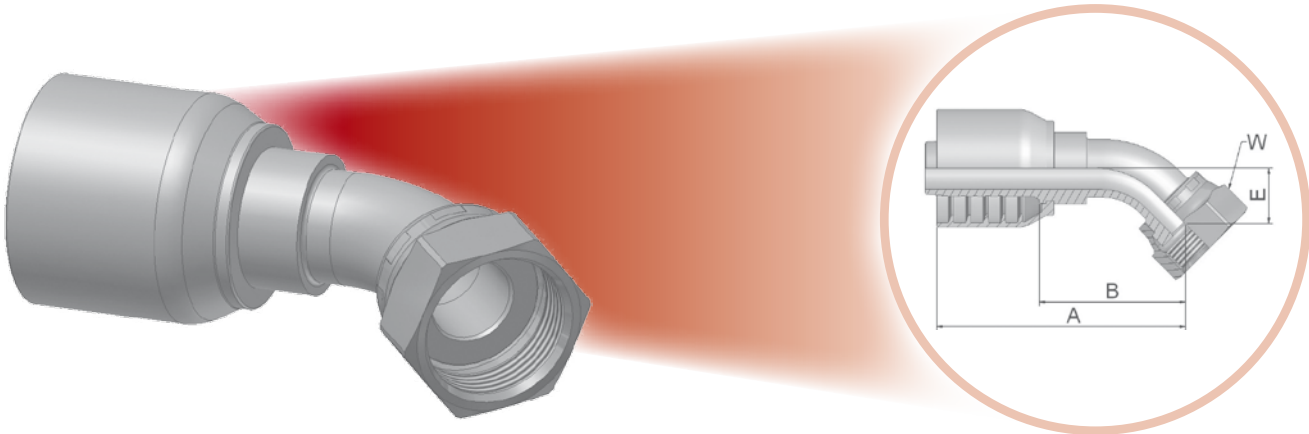

J7 - Female ORFS - Swivel - 45° Elbow - ISO 12151-1 - SWE 45°

ISO 12151-1-SWE45 - SAE J516 - ORFS 45°



Approved fitting series for hose types:



XXXX-XX-XX Part Number 	 Hose I.D.				 Thread UNF	A	B	E	 W
	DN	Inch	Size	mm					
1J773-12-12-SM	20	3/4	-12	19,1	1-3/16x12	105	57	21	36
1J773-16-12-SM	20	3/4	-12	19,1	1-7/16x12	107	59	24	41
1J773-16-16-SM	25	1	-16	25,4	1-7/16x12	119	69	24	41
1J773-20-16-SM	25	1	-16	25,4	1-11/16x12	131	80	26	50
1J773-20-20-SM	32	1.1/4	-20	31,8	1-11/16x12	154	90	30	50

Material: steel chromium(VI) free plated
SM: Metric Hexagon

Information about standard products or non-standard products can be found in the current price list.
Dimensions shown may be changed at any time without prior notice.



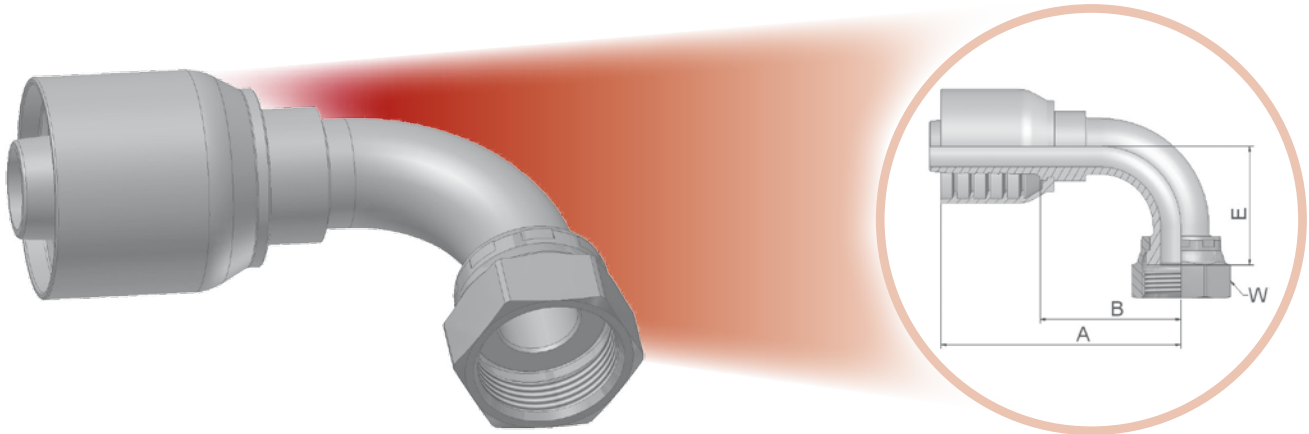

J9 – Female ORFS – Swivel – 90° Elbow – Short Drop

ISO 12151-1-SWES – SAE J516 – ORFS 90°



Approved fitting series for hose types:



XXXX-XX-XX Part Number 	 Hose I.D.				 Thread UNF	A	B	E	 W
	DN	Inch	Size	mm					
1J973-12-12-SM	20	3/4	-12	19,1	1-3/16x12	101	53	48	36
1J973-16-12-SM	20	3/4	-12	19,1	1-7/16x12	114	66	56	41
1J973-16-16-SM	25	1	-16	25,4	1-7/16x12	120	69	56	41
1J973-20-16-SM	25	1	-16	25,4	1-11/16x12	127	77	64	50
1J973-20-20-SM	32	1.1/4	-20	31,8	1-11/16x12	151	87	69	50

Material: steel chromium(VI) free plated
SM: Metric Hexagon

Information about standard products or non-standard products can be found in the current price list.
Dimensions shown may be changed at any time without prior notice.





JM- ORFS Male

ISO 12151-1-S – SAE J516



Approved fitting series for hose types:













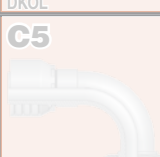

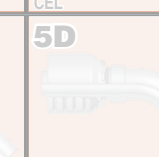
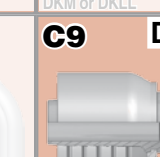
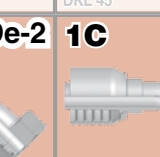

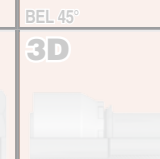
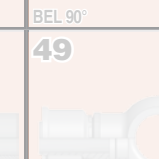
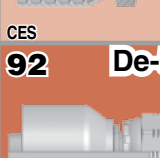
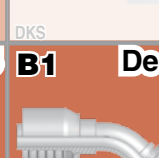
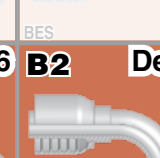
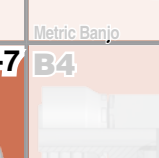
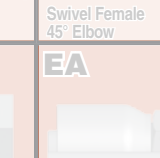
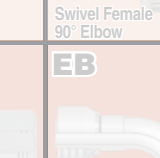
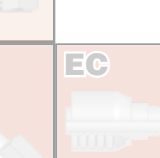

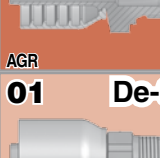

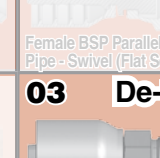
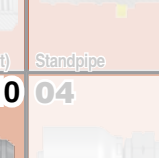
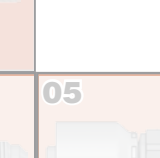
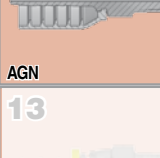
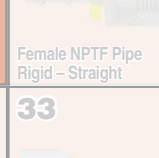
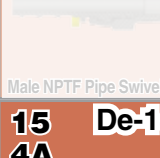
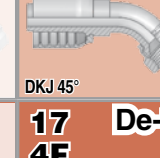
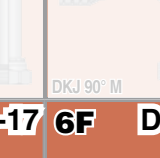
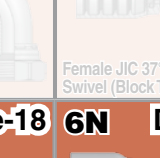
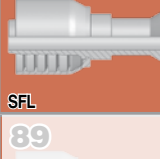

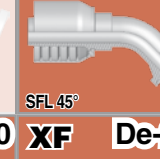
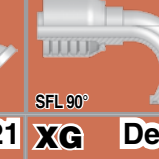
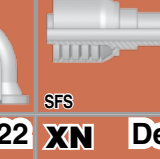

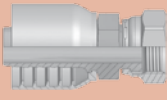
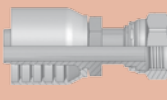
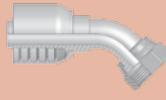
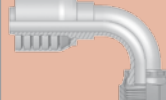

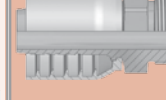





XXXX-XX-XX Part Number 	 Hose I.D.				 Thread UNF	A mm	B mm	 W mm
	DN	Inch	Size	mm				
1JM73-16-16-SM	25	1	-16	25,4	1-7/16x12	93	42	41
1JM73-20-16-SM	25	1	-16	25,4	1-11/16x12	89	39	46
1JM73-20-20-SM	32	1-1/4	-20	31,8	1-11/16x12	106	42	46



















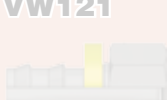

JM fittings are supplied without O-ring.
 Find O-rings in section E. Special O-rings are available on request.
 Material: steel chromium(VI) free plated
 SM: Metric Hexagon

Information about standard products or non-standard products can be found in the current price list.
 Dimensions shown may be changed at any time without prior notice.

Fittings Overview 78 Series

DIN	CA  DKOL	CE  DKOL 45°	CF  DKOL 90°	D0  CEL	C0  DKM or DKLL	C3  DKL	C4  DKL 45°	
	C5  DKL 90°	1D  BEL	DD  BEL 45°	5D  BEL 90°	C9 De-1  DKOS	0C De-2  DKOS 45°	1C De-3  DKOS 90°	
	D2 De-4  CES	C6  DKS	3D  BES	49  Metric Banjo	9B  Swivel Female 45° Elbow	9C  Swivel Female 90° Elbow		
	92 De-5  DKR	B1 De-6  DKR 45°	B2 De-7  DKR 90°	B4  DKR 90° (Compact)	EA  DKOR	EB  DKOR 45°	EC  DKOR 90°	
	D9 De-8  AGR	91  AGR-K	B5  Female BSP Parallel Pipe - Swivel (Flat Seat)	34  Standpipe				
	01 De-9  AGN	02  Female NPTF Pipe Rigid - Straight	03 De-10  AGJ	04  Male SAE 45° - Rigid	05  Male SAE Straight Thread with O-ring - Rigid	06 De-11 68  DKJ	08  AGS	
13  Male NPTF Pipe Swivel	33  Male JIC 37° - Rigid	37 De-12 3V  DKJ 45°	39 De-13 3W  DKJ 90°	41 3Y  DKJ 90° L	L9  DKJ 90° M	93  Female JIC 37° - Swivel (Block Type)		
15 De-14 4A  SFL	16  SFL 22.5°	17 De-15 4F  SFL 45°	19 De-16 4N  SFL 90°	6A De-17  SFS	6F De-18  SFS 45°	6N De-19  SFS 90°		
89  SFL 90° - long	XA De-20  Caterpillar Flange Head	XF De-21  Caterpillar Flange Head 45°	XG De-22  Caterpillar Flange Head 60°	XN De-23  Caterpillar Flange Head 90°				

ORFS	JC De-24  ORFS - short	JS De-25  ORFS - long	J7 De-26  ORFS 45°	J9 De-27  ORFS Female 90°	J1  ORFS 90° - extra long	J5  ORFS 90° - long	JM De-28  ORFS Male
	JD  Male ORFS - Bulkhead with Locknut (with O-ring)						
JIS	FU  GUI	GU  GUO	MU  Female Metric Swivel - (30° Flare)	MZ  Female Metric Swivel - (30° Flare)	UT  Male BSP Taper Pipe Rigid - (60° Cone)		
	French Standard	FG  Male Rigid Gas Series - (24° Cone)	F2  Female Swivel Gas Series	F4  Female Swivel Gas Series - (Ball Nose)	F6  Male Metric (24° Cone)	F9  Swivel Female Metric (Ball Nose)	FA  Metric Male for Agriculture Valves
High Pressure Cleaning		CW  Power Cleaner Connection	PW  Male Kärcher Metric Cleaning Hose Fitting - Rigid	NW  Female Kärcher Metric Cleaning Hose Fitting - (New Design)			

others	XU  Female Metric Swivel - (30° Flare)	XY  Female Metric Swivel - (30° Flare)	DK  Male Metric L - Rigid Bulkhead with Locknut (24° Cone)	DX  Female Metric Swivel (M27x2) O-ring - Light Series	FF  Metru-Lok Swivel Female	AF  Male BSP Parallel Pipe Rigid - Straight (with O-ring Seal)	NM  Male BSP Parallel Pipe - L Series - Rigid Straight - ED-Seal	
	YW  Male Standpipe - Rigid - Straight - A-Lok	VW121  BSP Swivel Female	82  Push-Lok Union	DP  Metric Swivel Female Tee / Male Stud	DR  Metric Swivel Female Tee	5C  60° Cone Swivel Female	6C  60° Cone Swivel Female - 45° Elbow	
	7C  60° Cone Swivel Female - 90° Elbow	5S  Female Tube O-ring Swivel - Short Pilot	5H  Female Tube O-ring Swivel - 45° Elbow Short Pilot	5T  Female Tube O-ring Swivel 90° Elbow Short Pilot	59PT  Male Tube O-ring Swivel - Long Pilot Charge Port at 180° for R134a	5LPT  Female Tube O-ring Swivel - 90° Elbow Long Pilot Charge Port at 180° for R134a	T1  Male Refrigerant Tube Mender - Straight (with Nut and Ferrule)	



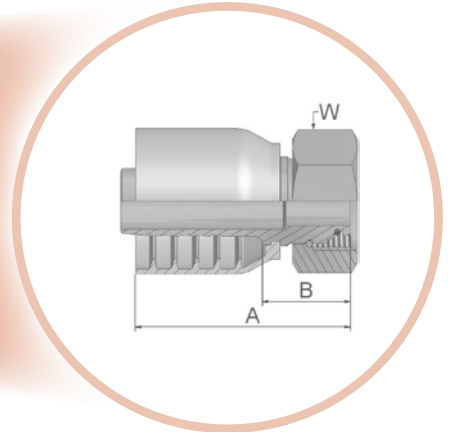
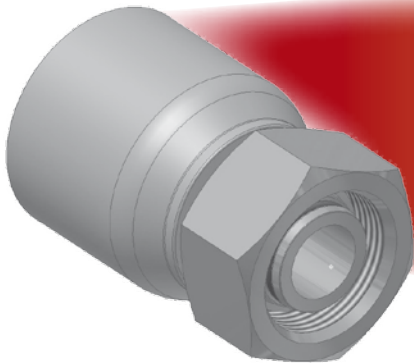

C9 – Female Metric 24° – Heavy Series with O-ring – Swivel – Straight

ISO 12151-2-SWS-S – DKOS



Approved fitting series for hose types:



XXXX-XX-XX Part Number 	 Hose I.D.				 Thread metric	 Tube O.D.	A	B	 W
	DN	Inch	Size	mm		mm	mm	mm	mm
1C978-20-12	20	3/4	-12	19,1	M30x2	20	81	33	36
1C978-25-12	20	3/4	-12	19,1	M36x2	25	80	32	46
1C978-30-16	25	1	-16	25,4	M42x2	30	87	36	50
1C978-30-20	32	1-1/4	-20	31,8	M42x2	30	106	42	50
1C978-38-20	32	1-1/4	-20	31,8	M52x2	38	102	35	60
1C978-38-24	40	1-1/2	-24	38,1	M52x2	38	105	42	60

Fittings with standard O-ring seals can be used for temperatures from -30 °C up to +105 °C.
Find O-rings in section E. Special O-rings are available on request
Material: steel chromium(VI) free plated

Information about standard products or non-standard products can be found in the current price list.
Dimensions shown may be changed at any time without prior notice.



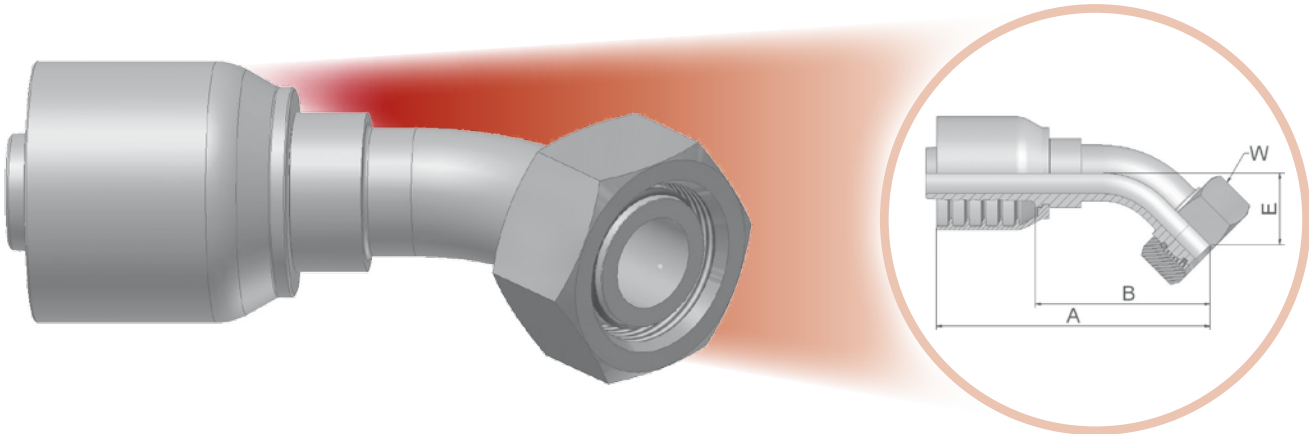

OC – Female Metric 24° – Heavy Series with O-ring – Swivel – 45° Elbow

ISO 12151-2-SWE45-S – DKOS 45°



Approved fitting series for hose types:



XXXX-XX-XX Part Number 	 Hose I.D.				 Thread metric	Tube O.D. mm	A mm	B mm	E mm	 W mm
	DN	Inch	Size	mm						
10C78-25-12	20	3/4	-12	19,1	M36x2	25	113	65	29	46
10C78-30-16	25	1	-16	25,4	M42x2	30	131	81	34	50
10C78-38-20	32	1-1/4	-20	31,8	M52x2	38	161	97	37	60
10C78-38-24	40	1-1/2	-24	38,1	M52x2	38	182	120	49	60

Fittings with standard O-ring seals can be used for temperatures from -30 °C up to +105 °C.
 Find O-rings in section E. Special O-rings are available on request
 Material: steel chromium(VI) free plated

Information about standard products or non-standard products can be found in the current price list.
 Dimensions shown may be changed at any time without prior notice.



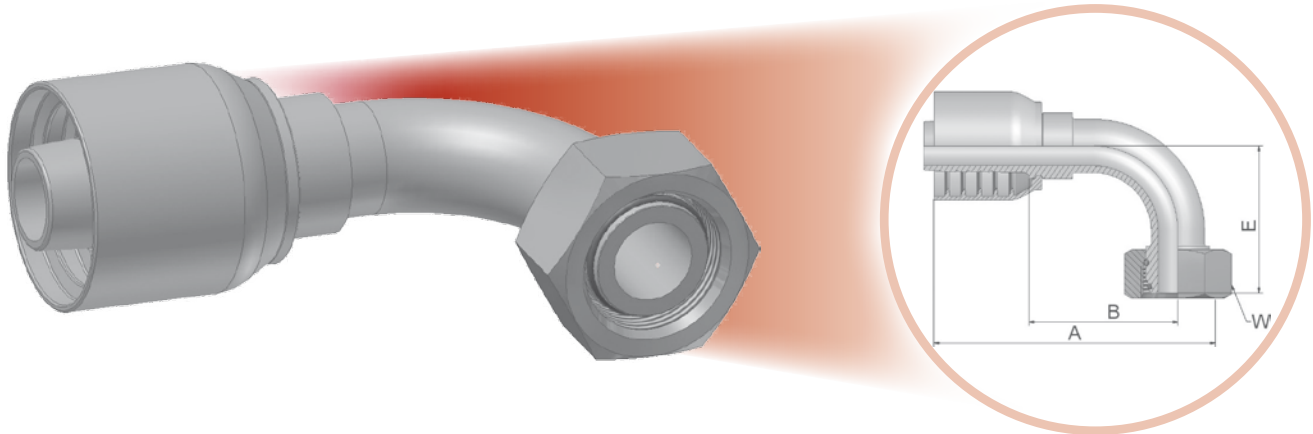

1C – Female Metric 24° – Heavy Series with O-ring – Swivel – 90° Elbow

ISO 12151-2-SWE-S – DKOS 90°



Approved fitting series for hose types:



XXXX-XX-XX Part Number 	 Hose I.D.				 Thread metric	Tube O.D. mm	A mm	B mm	E mm	 W mm
	DN	Inch	Size	mm						
11C78-20-12	20	3/4	-12	19,1	M30x2	20	101	53	57	36
11C78-25-12	20	3/4	-12	19,1	M36x2	25	101	52	59	46
11C78-30-16	25	1	-16	25,4	M42x2	30	122	72	73	50
11C78-38-20	32	1-1/4	-20	31,8	M52x2	38	151	87	78	60

Fittings with standard O-ring seals can be used for temperatures from -30 °C up to +105 °C.
Find O-rings in section E. Special O-rings are available on request
Material: steel chromium(VI) free plated

Information about standard products or non-standard products can be found in the current price list.
Dimensions shown may be changed at any time without prior notice.



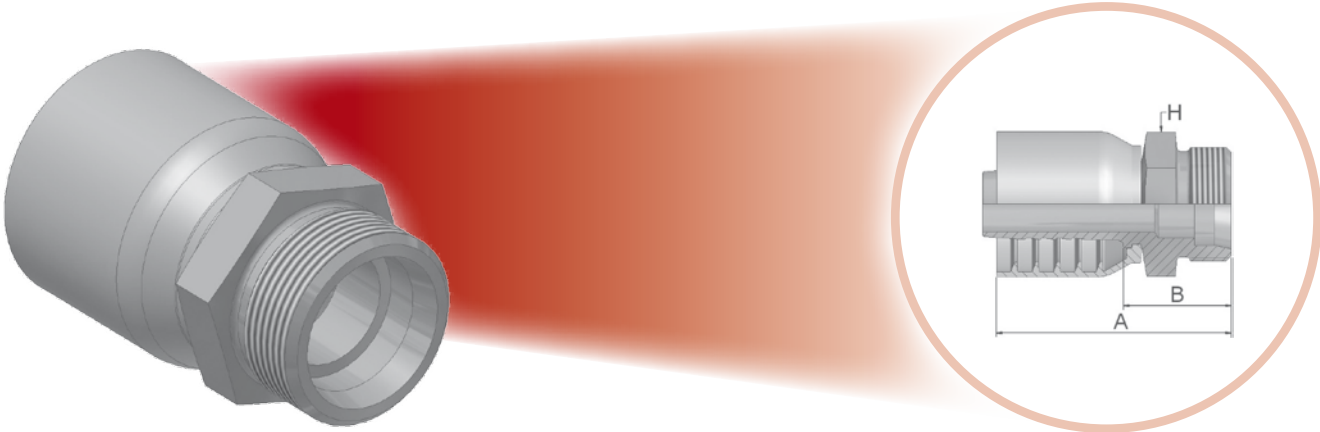

D2 – Male Metric 24° – Heavy Series – Rigid – Straight

ISO 12151-2-S-S – CES



Approved fitting series for hose types:



XXXX.XX.XX Part Number 	 Hose I.D.				 Thread metric	Tube O.D. mm	A mm	B mm	 H mm
	DN	Inch	Size	mm					
1D278-25-12	20	3/4	-12	19,1	M36x2	25	86	37	36
1D278-30-16	25	1	-16	25,4	M42x2	30	95	42	46
1D278-38-20	32	1-1/4	-20	31,8	M52x2	38	112	46	55

Material: steel chromium(VI) free plated

Information about standard products or non-standard products can be found in the current price list.
Dimensions shown may be changed at any time without prior notice.



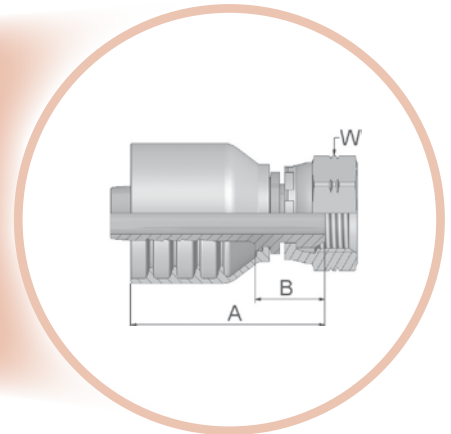
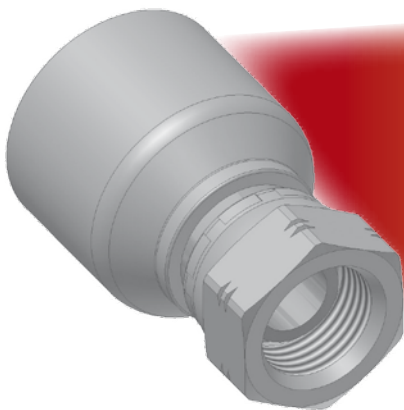

92 - Female BSP Parallel Pipe – Swivel – Straight (60° Cone)

BS5200-A – DKR



Approved fitting series for hose types:



XXXX-XX-XX Part Number 	 Hose I.D.				 Thread BSP	A mm	B mm	 W mm
	DN	Inch	Size	mm				
19278-12-12	20	3/4	-12	19,1	3/4x14	77	29	32
19278-16-16	25	1	-16	25,4	1x11	89	39	41
19278-20-20	32	1-1/4	-20	31,8	1-1/4x11	101	37	50
19278-24-24	40	1-1/2	-24	38,1	1-1/2x11	100	37	55

Material: steel chromium(VI) free plated

Information about standard products or non-standard products can be found in the current price list.
Dimensions shown may be changed at any time without prior notice.



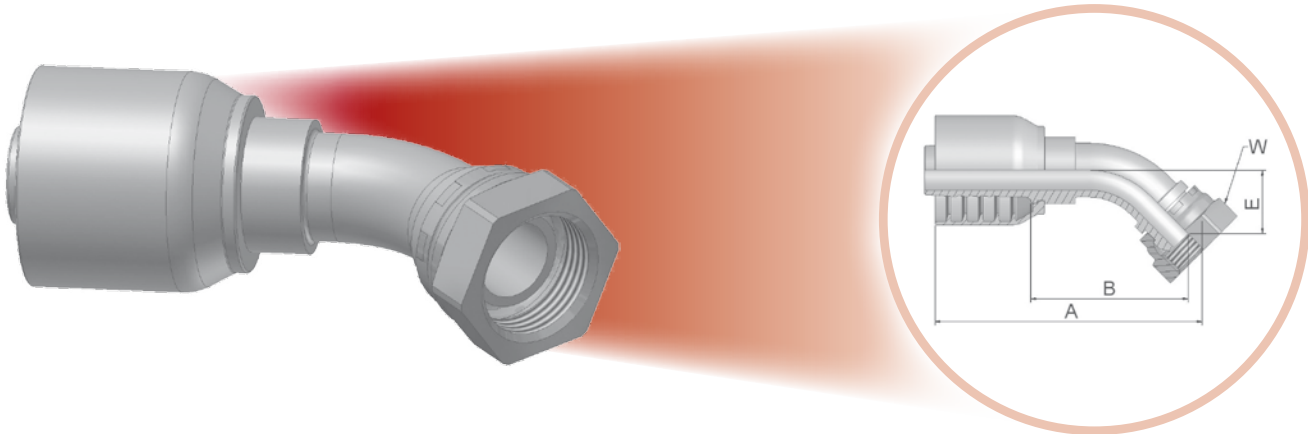

B1 - Female BSP Parallel Pipe - Swivel - 45° Elbow (60° Cone)

BS 5200-D - DKR 45°



Approved fitting series for hose types:



XXXX.XX.XX Part Number 	 Hose I.D.				 Thread BSP	A mm	B mm	E mm	 W mm
	DN	Inch	Size	mm					
1B178-12-12	20	3/4	-12	19,1	3/4x14	110	62	26	32
1B178-16-16	25	1	-16	25,4	1x11	134	81	38	41
1B178-20-20	32	1-1/4	-20	31,8	1-1/4x11	169	105	44	50
1B178-24-24	40	1-1/2	-24	38,1	1-1/2x11	172	109	38	55

Material: steel chromium(VI) free plated

Information about standard products or non-standard products can be found in the current price list. Dimensions shown may be changed at any time without prior notice.



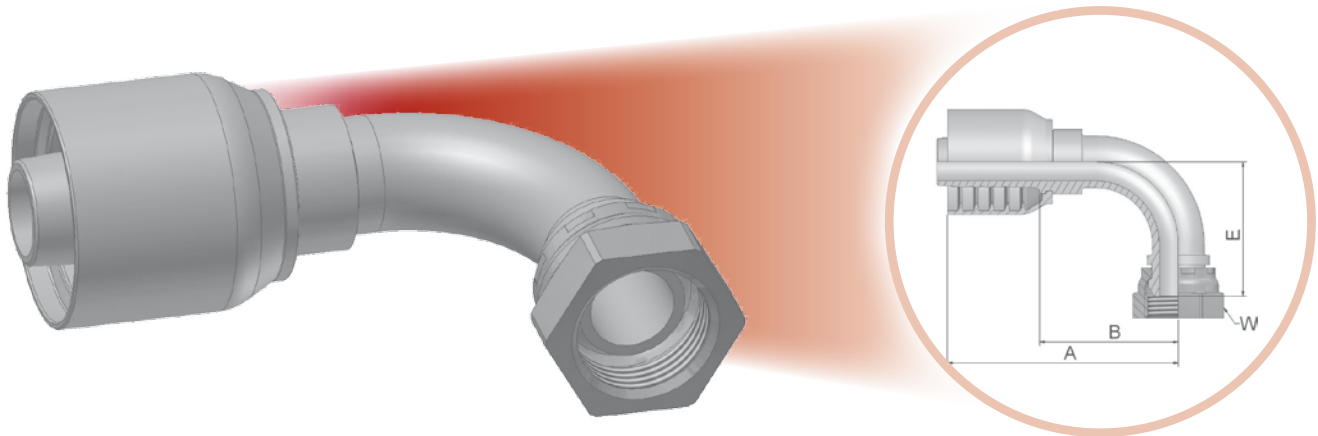

B2 – Female BSP Parallel Pipe – Swivel – 90° Elbow (60° Cone)

BS 5200-B – DKR 90°



Approved fitting series for hose types:



XXXX-XX-XX Part Number 	 Hose I.D.				 Thread BSP	A	B	E	 W
	DN	Inch	Size	mm					
1B278-12-12	20	3/4	-12	19,1	3/4x14	106	58	55	32
1B278-16-16	25	1	-16	25,4	1x11	121	70	76	41
1B278-20-20	32	1-1/4	-20	31,8	1-1/4x11	151	87	80	50
1B278-24-24	40	1-1/2	-24	38,1	1-1/2x11	166	103	103	55

Material: steel chromium(VI) free plated

Information about standard products or non-standard products can be found in the current price list.
Dimensions shown may be changed at any time without prior notice.



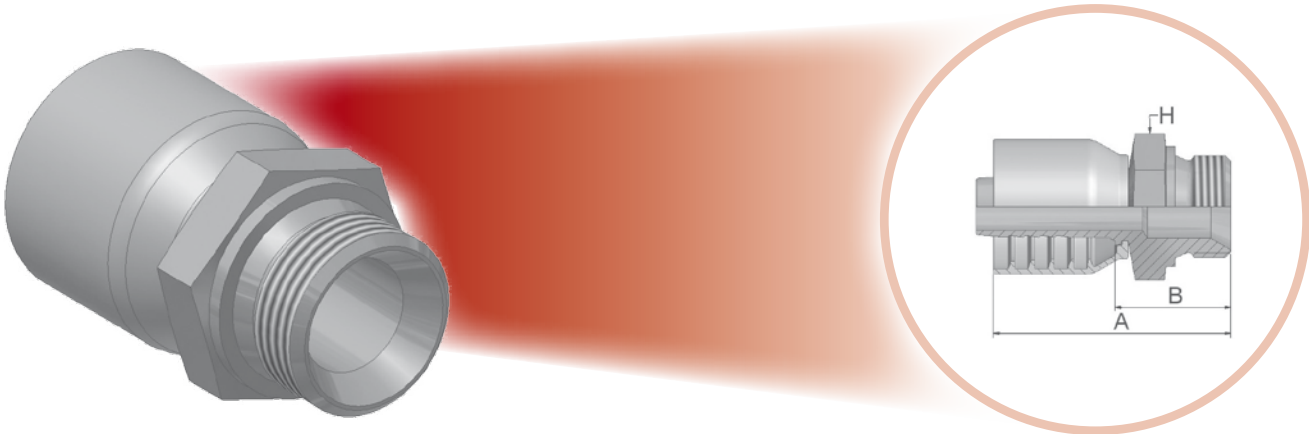

D9 – Male BSP Parallel Pipe – Rigid – Straight (60° Cone)

BS5200 – AGR



Approved fitting series for hose types:



XXXX-XX-XX Part Number 	 Hose I.D.				 Thread BSP	A mm	B mm	 H mm
	DN	Inch	Size	mm				
1D978-12-12	20	3/4	-12	19,1	3/4x14	87	38	32
1D978-16-16	25	1	-16	25,4	1x11	96	43	41
1D978-20-20	32	1-1/4	-20	31,8	1-1/4x11	113	47	50
1D978-24-24	40	1-1/2	-24	38,1	1-1/2x11	114	49	55

Material: steel chromium(VI) free plated

Information about standard products or non-standard products can be found in the current price list.
Dimensions shown may be changed at any time without prior notice.



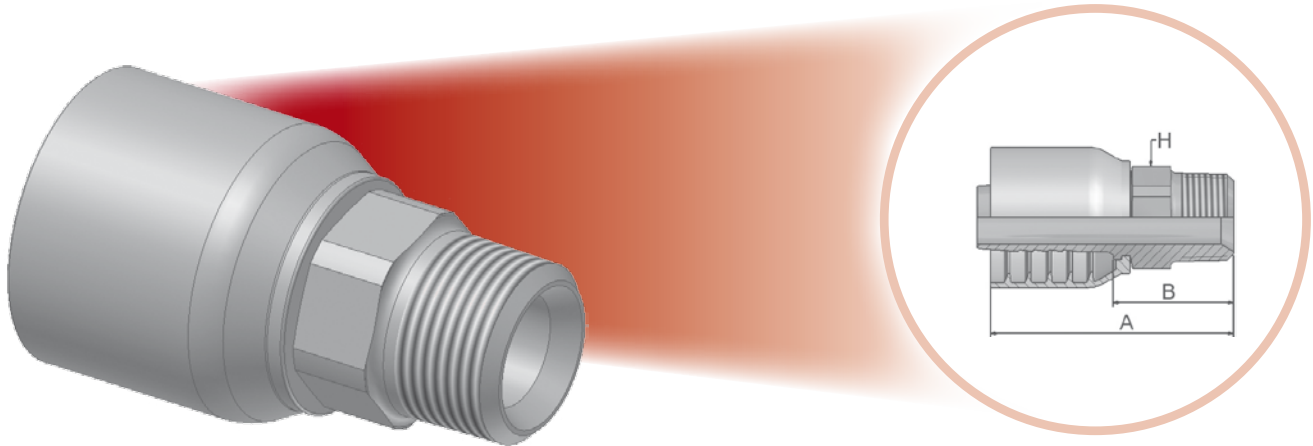

01 - Male NPTF Pipe - Rigid - Straight

SAE J476A - J516 - AGN



Approved fitting series for hose types:



XXXX-XX-XX Part Number 	Hose I.D. 				Thread NPTF 	A mm	B mm	H mm / Inch 
	DN	Inch	Size	mm				
10178-12-12-SM	20	3/4	-12	19,1	3/4x14	90	42	30
10178-16-16	25	1	-16	25,4	1x11-1/2	100	51	1-3/8
10178-20-20-SM	32	1.1/4	-20	31,8	1-1/4x11-1/2	125	61	46
10178-24-24-SM	40	1-1/2	-24	38,1	1-1/2x11-1/2	124	61	50

Material: steel chromium(VI) free plated
SM: Metric Hexagon

Information about standard products or non-standard products can be found in the current price list.
Dimensions shown may be changed at any time without prior notice.



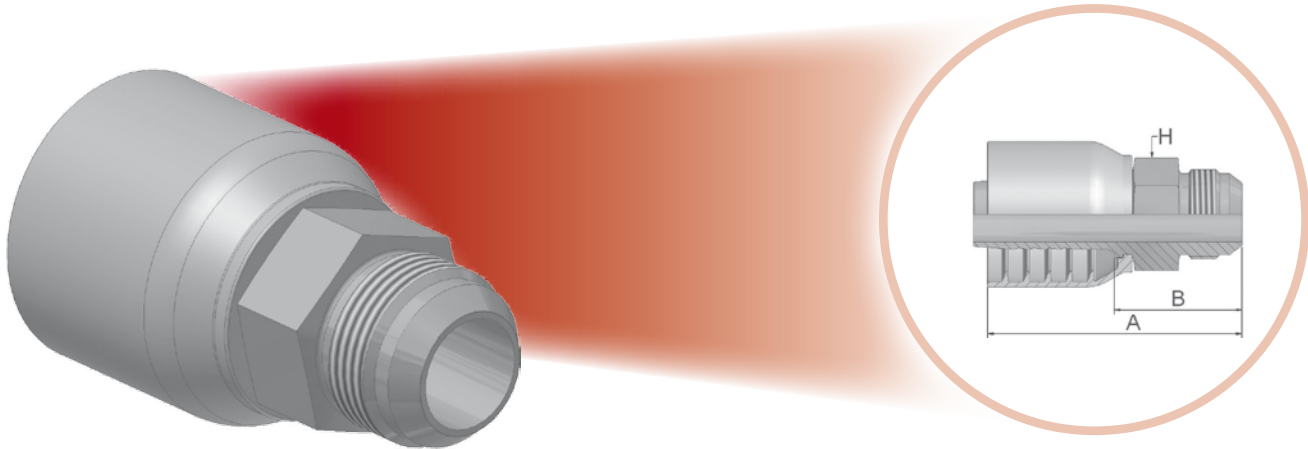

03 - Male JIC 37° - Rigid - Straight

ISO 12151-5-S – AGJ



Approved fitting series for hose types:



XXXX-XX-XX Part Number 	 Hose I.D.				 Thread UNF	A	B	 H
	DN	Inch	Size	mm				
10378-12-12-SM	20	3/4	-12	19,1	1-1/16x12	89	41	30
10378-16-16-SM	25	1	-16	25,4	1-5/16x12	97	47	36
10378-20-20-SM	32	1-1/4	-20	31,8	1-5/8x12	118	54	46
10378-24-24-SM	40	1-1/2	-24	38,1	1-7/8x12	122	59	50

Material: steel chromium(VI) free plated
SM: Metric Hexagon

Information about standard products or non-standard products can be found in the current price list.
Dimensions shown may be changed at any time without prior notice.



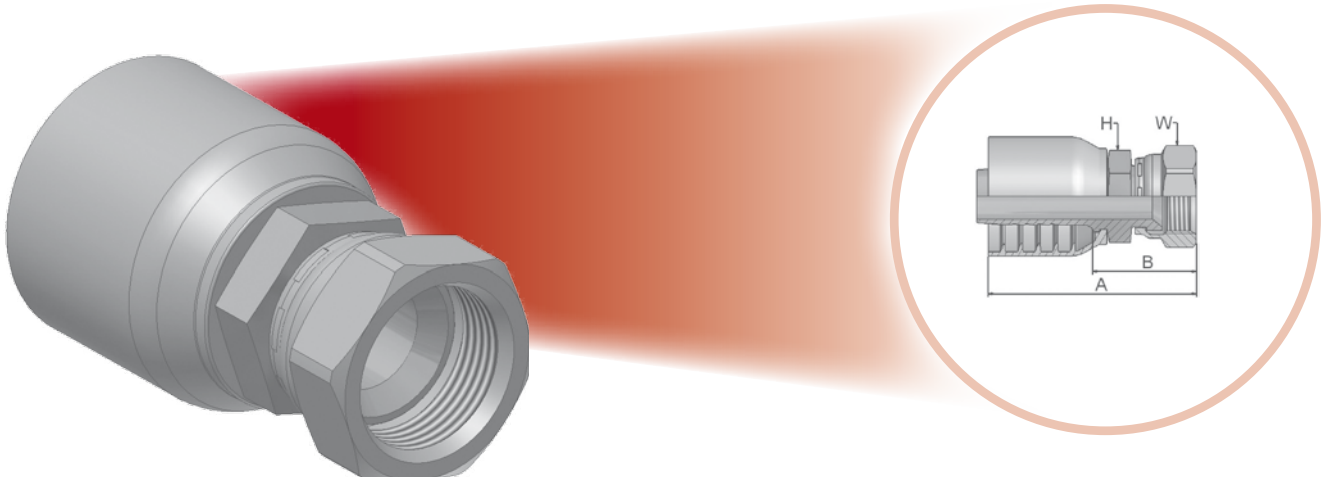

06 – Female JIC 37° Swivel – Straight

ISO 12151-5-SWS – DKJ



Approved fitting series for hose types:



XXXX-XX-XX Part Number 	 Hose I.D.				 Thread UNF	A mm	B mm	 H mm	 W mm
	DN	Inch	Size	mm					
10678-12-12-SM	20	3/4	-12	19,1	1-1/16x12	93	45	30	32
10678-16-16-SM	25	1	-16	25,4	1-5/16x12	103	52	36	41
10678-16-20-SM	32	1-1/4	-20	31,8	1-5/16x12	116	52	46	41
10678-20-20-SM	32	1-1/4	-20	31,8	1-5/8x12	125	61	46	55
10678-24-24-SM	40	1-1/2	-24	38,1	1-7/8x12	128	66	50	60

Material: steel chromium(VI) free plated
SM: Metric Hexagon

Information about standard products or non-standard products can be found in the current price list.
Dimensions shown may be changed at any time without prior notice.



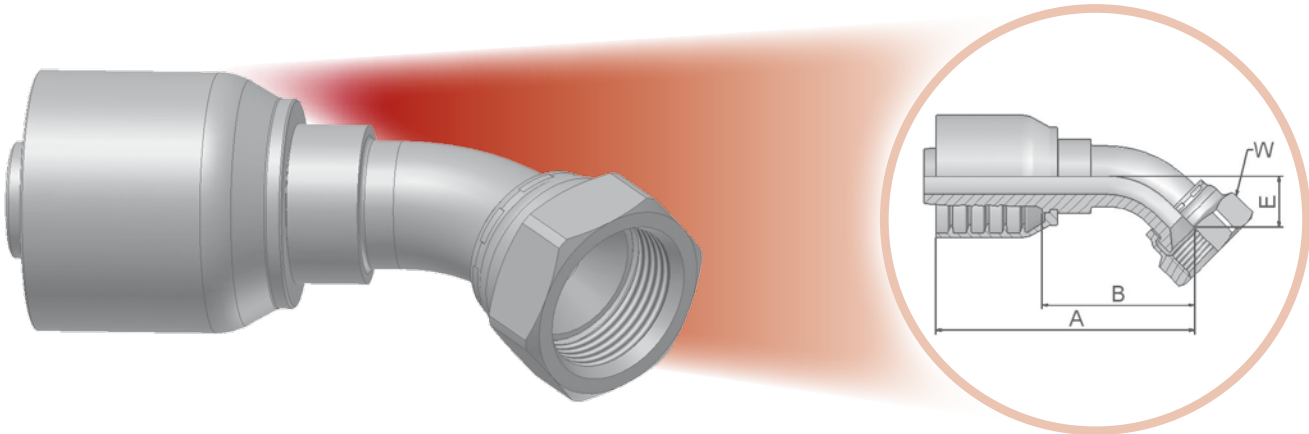

37 - Female JIC 37° - Swivel - 45° Elbow

ISO 12151-5-SWE45 - DKJ 45°



Approved fitting series for hose types:



XXXX.XX.XX Part Number 	 Hose I.D.				 Thread UNF	A	B	E	 W
	DN	Inch	Size	mm		mm	mm	mm	mm
13778-12-12-SM	20	3/4	-12	19,1	1-1/16x12	104	56	21	32
13778-16-16-SM	25	1	-16	25,4	1-5/16x12	119	69	24	41
13778-20-20-SM	32	1-1/4	-20	31,8	1-5/8x12	172	108	47	55
13778-24-24-SM	40	1-1/2	-24	38,1	1-7/8x12	194	132	58	60

Material: steel chromium(VI) free plated
SM: Metric Hexagon

Information about standard products or non-standard products can be found in the current price list.
Dimensions shown may be changed at any time without prior notice.



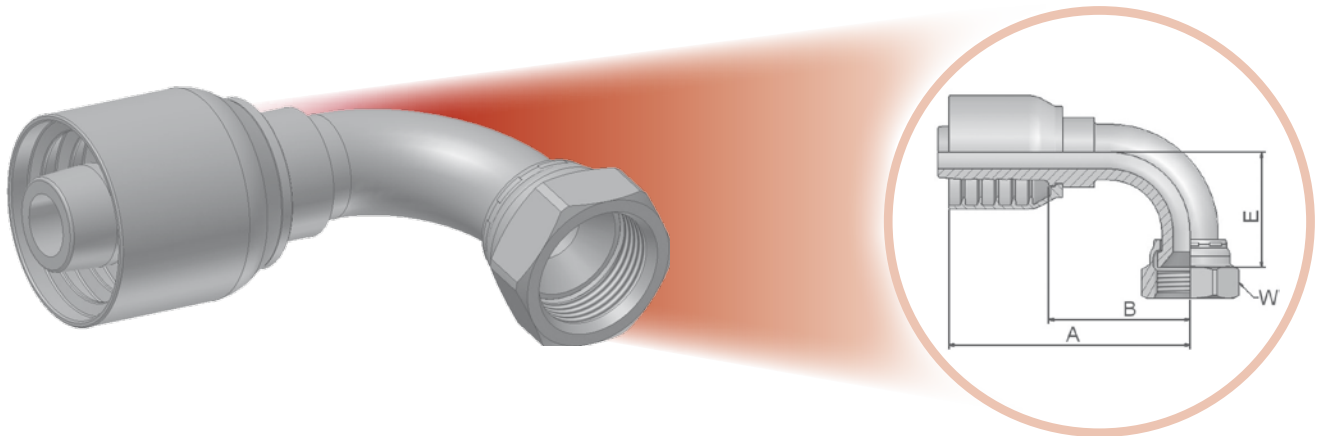

39 - Female JIC 37° - Swivel - 90° Elbow

ISO 12151-5-SWES – DKJ 90°



Approved fitting series for hose types:



XXXX-XX-XX Part Number 	 Hose I.D.				 Thread UNF	A	B	E	 H
	DN	Inch	Size	mm		mm	mm	mm	mm / Inch
13978-12-12	20	3/4	-12	19,1	1-1/16x12	103	59	62	1-1/2
13978-16-16	25	1	-16	25,4	1-5/16x12	118	70	74	1-1/2
13978-20-20-SM	32	1.1/4	-20	31,8	1-5/8x12	151	87	85	55
13978-24-24	40	1-1/2	-24	38,1	1-7/8x12	180	122	102	2-1/4

Material: steel chromium(VI) free plated
SM: Metric Hexagon

Information about standard products or non-standard products can be found in the current price list.
Dimensions shown may be changed at any time without prior notice.

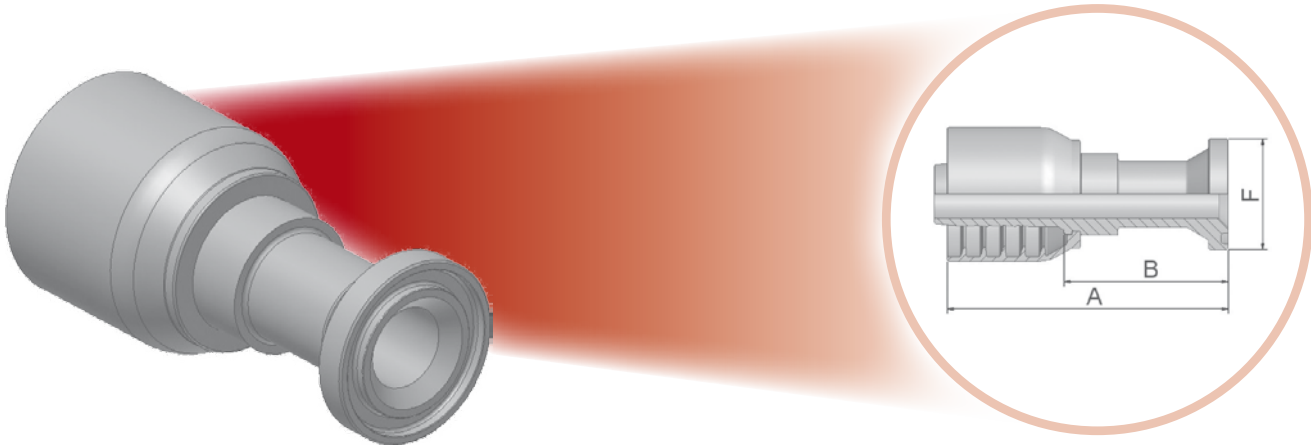

15/4A – SAE Code 61 – Flange Head – Straight (5000 psi)

ISO 12151-3-SL – SFL



Approved fitting series for hose types:



XXXX-XX-XX Part Number 	 Hose I.D.				 End Connection	A	B	F
	DN	Inch	Size	mm				
11578-12-12	20	3/4	-12	19,1	3/4	110	62	38
11578-16-16	25	1	-16	25,4	1	117	66	45
11578-16-20	32	1-1/4	-20	31,8	1	133	69	45
14A78-20-16	25	1	-16	25,4	1-1/4	85	34	51
14A78-20-20	32	1-1/4	-20	31,8	1-1/4	141	77	51
14A78-24-20	32	1-1/4	-20	31,8	1-1/2	104	40	60
14A78-24-24	40	1-1/2	-24	38,1	1-1/2	166	103	60

Find SAE flange halves in section Eb.

Fittings with standard O-ring seals can be used for temperatures from -30 °C up to +105 °C.

Find O-rings in section E. Special O-rings are available on request.

Material: steel chromium(VI) free plated

Information about standard products or non-standard products can be found in the current price list.
Dimensions shown may be changed at any time without prior notice.

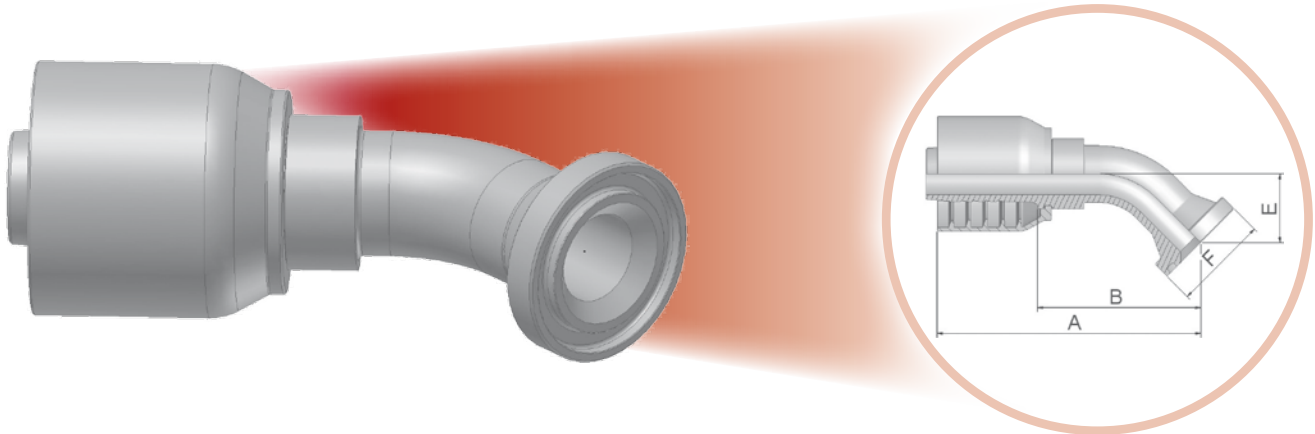

17/4F – SAE Code 61 – Flange Head 45° Elbow – 45° Elbow (5000 psi)

ISO 12151-3-E45S-L – SFL 45°



Approved fitting series for hose types:



XXXX-XX-XX Part Number 	 Hose I.D.				 End Connection	A	B	E	F
	DN	Inch	Size	mm					
11778-12-12	20	3/4	-12	19,1	3/4	119	71	27	38
11778-16-16	25	1	-16	25,4	1	127	77	32	45
14F78-20-16	25	1	-16	25,4	1-1/4	136	85	32	51
14F78-20-20	32	1-1/4	-20	31,8	1-1/4	160	96	35	51
14F78-24-20	32	1-1/4	-20	31,8	1-1/2	162	102	38	60
14F78-24-24	40	1-1/2	-24	38,1	1-1/2	178	115	44	60
14F78-32-24	40	1-1/2	-24	38,1	2	177	114	43	71

Find SAE flange halves in section Eb.
 Fittings with standard O-ring seals can be used for temperatures from -30 °C up to +105 °C.
 Find O-rings in section E. Special O-rings are available on request.
 Material: steel chromium(VI) free plated

Information about standard products or non-standard products can be found in the current price list.
 Dimensions shown may be changed at any time without prior notice.

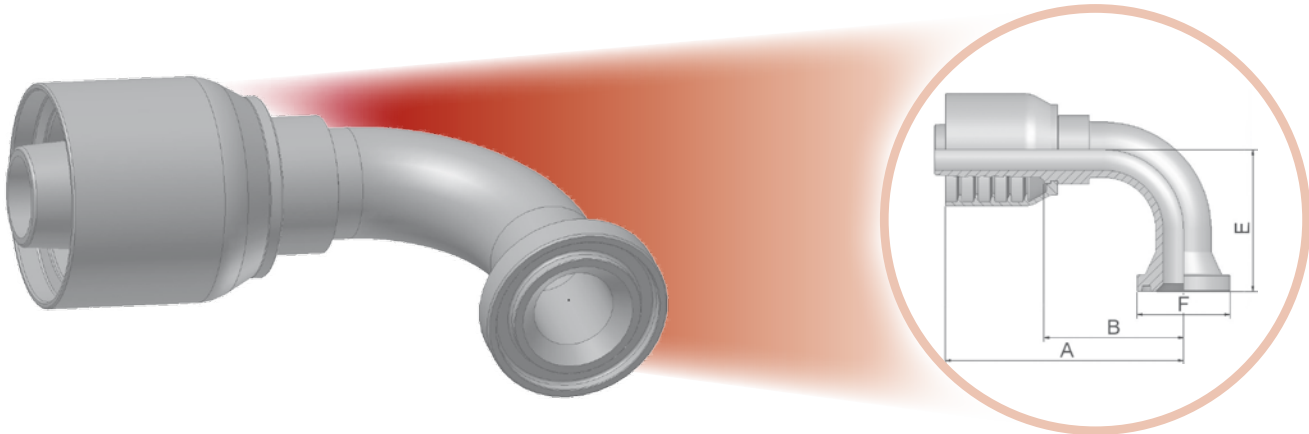

19/4N – SAE Code 61 – Flange Head – 90° Elbow (5000 psi)

ISO 12151-3-E90ML – SFL 90°



Approved fitting series for hose types:



XXXX·XX·XX Part Number 	 Hose I.D.				 End Connection	A	B	E	F
	DN	Inch	Size	mm		mm	mm	mm	mm
11978-12-12	20	3/4	-12	19,1	3/4	109	61	58	38
11978-16-12	20	3/4	-12	19,1	1	102	54	58	45
11978-16-16	25	1	-16	25,4	1	118	67	70	45
14N78-20-16	25	1	-16	25,4	1-1/4	128	78	68	51
14N78-20-20	32	1-1/4	-20	31,8	1-1/4	155	91	90	51
14N78-24-20	32	1-1/4	-20	31,8	1-1/2	155	91	90	60
14N78-24-24	40	1-1/2	-24	38,1	1-1/2	166	103	93	60

Find SAE flange halves in section Eb.

Fittings with standard O-ring seals can be used for temperatures from -30 °C up to +105 °C.

Find O-rings in section E. Special O-rings are available on request.

Material: steel chromium(VI) free plated

Information about standard products or non-standard products can be found in the current price list.
Dimensions shown may be changed at any time without prior notice.

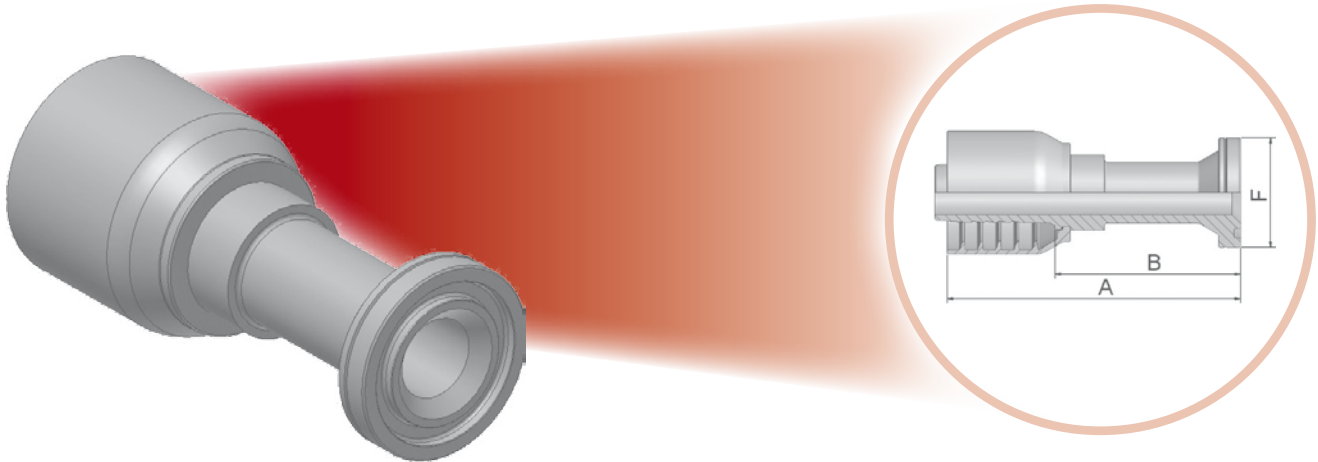

6A – SAE Code 62 – Flange – Straight

ISO 12151-3-S-S – SFS – 6000 psi



Approved fitting series for hose types:



XXXX-XX-XX Part Number 	 Hose I.D.				 End Connection	A	B	F
	DN	Inch	Size	mm				
16A78-12-12	20	3/4	-12	19,1	3/4	130	82	41
16A78-16-12	20	3/4	-12	19,1	1	135	87	48
16A78-16-16	25	1	-16	25,4	1	131	81	48
16A78-20-16	25	1	-16	25,4	1-1/4	142	91	54
16A78-16-20	32	1-1/4	-20	31,8	1	149	85	48
16A78-20-20	32	1-1/4	-20	31,8	1-1/4	149	85	54
16A78-24-20	32	1-1/4	-20	31,8	1-1/2	121	57	64
16A78-20-24	40	1-1/2	-24	38,1	1-1/4	158	96	54
16A78-24-24	40	1-1/2	-24	38,1	1-1/2	166	104	64
16A78-32-24	40	1-1/2	-24	38,1	2	174	117	79

Find SAE flange halves in section Eb.

Fittings with standard O-ring seals can be used for temperatures from -30 °C up to +105 °C.

Find O-rings in section E. Special O-rings are available on request.

Material: steel chromium(VI) free plated

Information about standard ring products or non-standard products can be found in the current price list.
Dimensions shown may be changed at any time without prior notice.

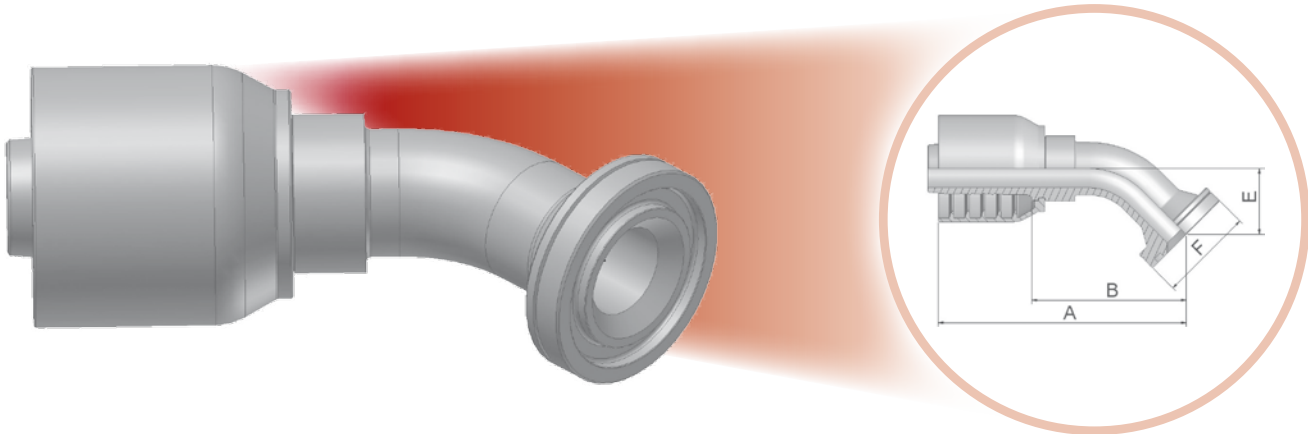

6F – SAE Flange 45° Elbow – Heavy Series

ISO 12151-3-E45-S – SFS 45° – 6000 psi



Approved fitting series for hose types:



XXXX-XX-XX Part Number 	 Hose I.D.				 End Connection	A	B	E	F
	DN	Inch	Size	mm		mm	mm	mm	mm
16F78-12-12	20	3/4	-12	19,1	3/4	110	62	26	41
16F78-16-12	20	3/4	-12	19,1	1	110	62	26	48
16F78-16-16	25	1	-16	25,4	1	129	79	32	48
16F78-20-16	25	1	-16	25,4	1-1/4	129	79	32	54
16F78-16-20	32	1-1/4	-20	31,8	1	157	93	33	48
16F78-20-20	32	1-1/4	-20	31,8	1-1/4	163	98	38	54
16F78-24-20	32	1-1/4	-20	31,8	1-1/2	163	99	38	63
16F78-24-24	40	1-1/2	-24	38,1	1-1/2	178	115	44	64

Find SAE flange halves in section Eb.
 Fittings with standard O-ring seals can be used for temperatures from -30 °C up to +105 °C.
 Find O-rings in section E. Special O-rings are available on request.
 Material: steel chromium(VI) free plated

Information about standard products or non-standard products can be found in the current price list.
 Dimensions shown may be changed at any time without prior notice.

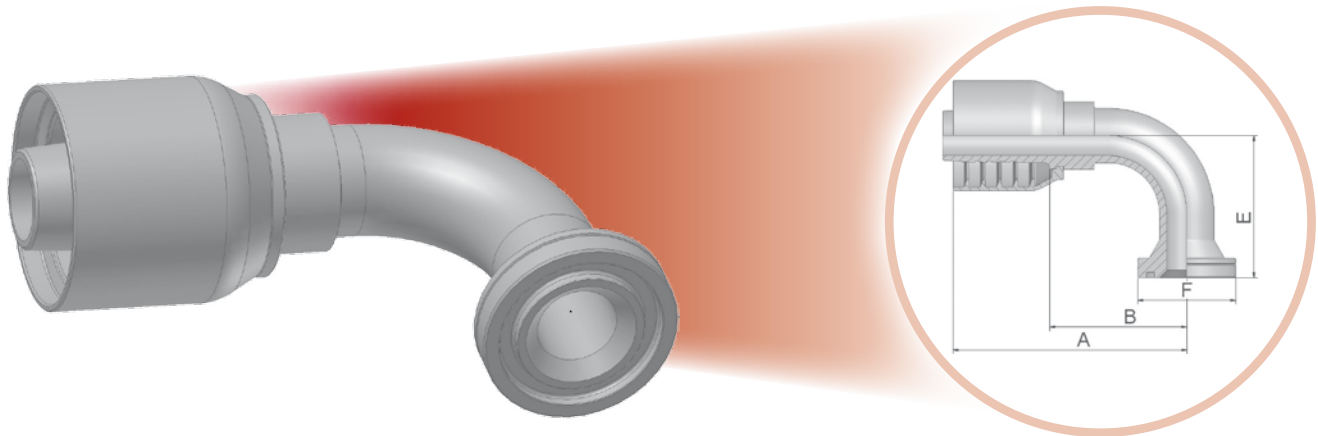

6N – SAE Code 62 Flange Head – 90° Elbow

ISO 12151-3-E-S – SFS 90° – 6000 psi



Approved fitting series for hose types:



XXXX-XX-XX Part Number 	 Hose I.D.				 End Connection	A	B	E	F
	DN	Inch	Size	mm					
16N78-12-12	20	3/4	-12	19,1	3/4	101	53	58	41
16N78-16-12	20	3/4	-12	19,1	1	109	65	62	48
16N78-12-16	25	1	-16	25,4	3/4	109	58	70	41
16N78-16-16	25	1	-16	25,4	1	122	71	70	48
16N78-20-16	25	1	-16	25,4	1-1/4	122	71	70	54
16N78-24-16	25	1	-16	25,4	1-1/2	126	79	69	64
16N78-20-20	32	1-1/4	-20	31,8	1-1/4	172	108	71	54
16N78-24-20	32	1-1/4	-20	31,8	1-1/2	172	108	76	64
16N78-20-24	40	1-1/2	-24	38,1	1-1/4	170	113	76	54
16N78-24-24	40	1-1/2	-24	38,1	1-1/2	166	103	104	64

Find SAE flange halves in section Eb.

Fittings with standard O-ring seals can be used for temperatures from -30 °C up to +105 °C.

Find O-rings in section E. Special O-rings are available on request.

Material: steel chromium(VI) free plated

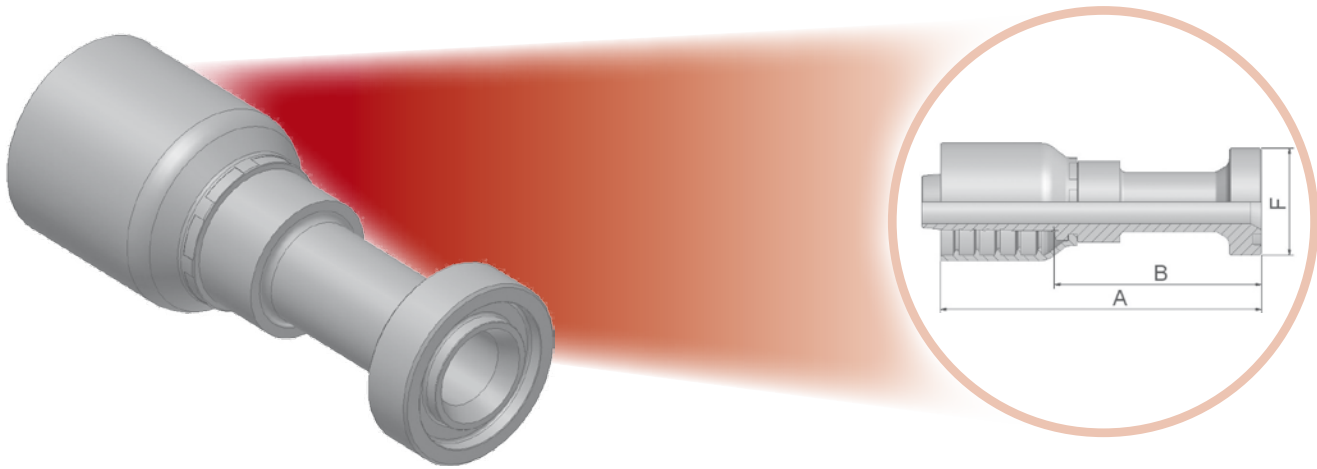

Information about standard products or non-standard products can be found in the current price list.
Dimensions shown may be changed at any time without prior notice.

XA - Caterpillar® Flange Head - Straight



Approved fitting series for hose types:



XXXX-XX-XX Part Number 	 Hose I.D.				 End Connection	A mm	B mm	F mm
	DN	Inch	Size	mm				
1XA78-12-12	20	3/4	-12	19,1	3/4	123	75	41
1XA78-16-12	20	3/4	-12	19,1	1	134	86	48
1XA78-16-16	25	1	-16	25,4	1	138	88	48
1XA78-20-16	25	1	-16	25,4	1-1/4	144	93	54
1XA78-20-20	32	1-1/4	-20	31,8	1-1/4	155	96	54
1XA78-24-20	32	1-1/4	-20	31,8	1-1/2	162	97	64
1XA78-24-24	40	1-1/2	-24	38,1	1-1/2	172	110	64

Fittings with standard O-ring seals can be used for temperatures from -30 °C up to +105 °C.
Find O-rings in section E. Special O-rings are available on request.
Find SAE flange halves and O-rings in section E.
Material: steel chromium(VI) free plated

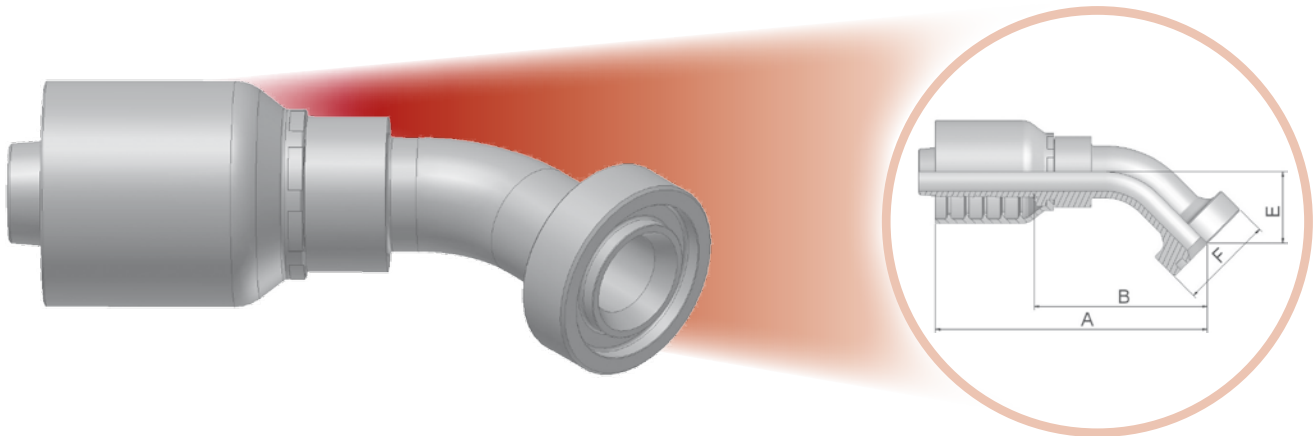

Information about standard products or non-standard products can be found in the current price list.
Dimensions shown may be changed at any time without prior notice.

XF - Caterpillar® Flange Head - 45° Elbow



Approved fitting series for hose types:



XXXX-XX-XX Part Number 	 Hose I.D.				 End Connection	A	B	E	F
	DN	Inch	Size	mm					
1XF78-12-12	20	3/4	-12	19,1	3/4	123	75	31	41
1XF78-16-12	20	3/4	-12	19,1	1	122	74	30	48
1XF78-16-16	25	1	-16	25,4	1	138	88	36	48
1XF78-20-16	25	1	-16	25,4	1-1/4	132	81	35	54
1XF78-20-20	32	1-1/4	-20	31,8	1-1/4	162	98	37	54
1XF78-24-20	32	1-1/4	-20	31,8	1-1/2	182	117	36	64
1XF78-24-24	40	1-1/2	-24	38,1	1-1/2	174	116	39	63
1XF78-32-24	40	1-1/2	-24	38,1	2	179	123	43	79

Fittings with standard O-ring seals can be used for temperatures from -30 °C up to +105 °C.
 Find O-rings in section E. Special O-rings are available on request.
 Find SAE flange halves and O-rings in section E.
 Material: steel chromium(VI) free plated

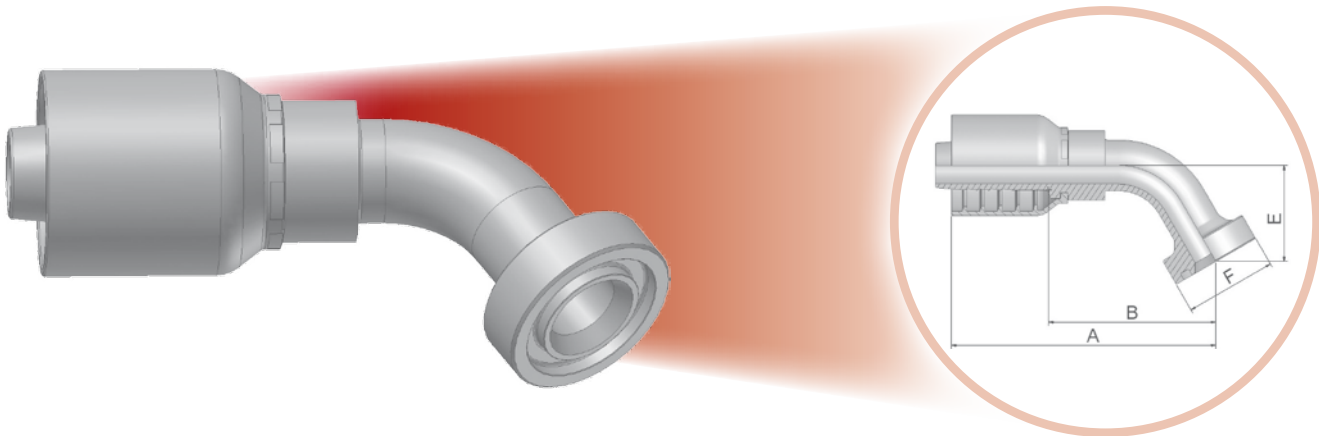

Information about standard products or non-standard products can be found in the current price list.
 Dimensions shown may be changed at any time without prior notice.

XG – Caterpillar® Flange Head – 60° Elbow



Approved fitting series for hose types:



XXXX·XX·XX Part Number 	 Hose I.D.				 End Connection	A	B	E	F
	DN	Inch	Size	mm		mm	mm	mm	mm
1XG78-12-12	20	3/4	-12	19,1	3/4	138	90	42	41
1XG78-16-12	20	3/4	-12	19,1	1	119	75	41	47
1XG78-16-16	25	1	-16	25,4	1	160	109	50	48
1XG78-20-16	25	1	-16	25,4	1-1/4	153	103	48	54
1XG78-20-20	32	1-1/4	-20	31,8	1-1/4	170	107	52	54
1XG78-24-20	32	1-1/4	-20	31,8	1-1/2	170	107	51	63
1XG78-24-24	40	1-1/2	-24	38,1	1-1/2	212	149	52	64

Fittings with standard O-ring seals can be used for temperatures from -30 °C up to +105 °C.
 Find O-rings in section E. Special O-rings are available on request.
 Find SAE flange halves and O-rings in section E.
 Material: steel chromium(VI) free plated

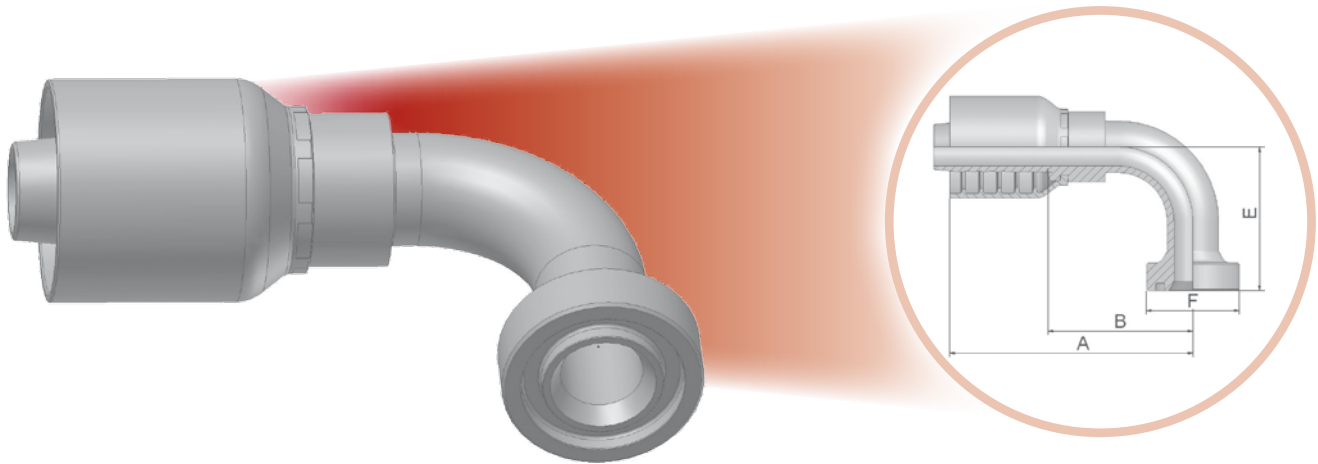

Information about standard products or non-standard products can be found in the current price list.
 Dimensions shown may be changed at any time without prior notice.

XN – Caterpillar® Flange Head – 90° Elbow



Approved fitting series for hose types:



XXXX-XX-XX Part Number 	 Hose I.D.				 End Connection	A	B	E	F
	DN	Inch	Size	mm					
1XN78-12-12	20	3/4	-12	19,1	3/4	111	63	63	41
1XN78-16-12	20	3/4	-12	19,1	1	111	63	62	48
1XN78-12-16	25	1	-16	25,4	3/4	115	67	62	41
1XN78-16-16	25	1	-16	25,4	1	128	78	74	48
1XN78-20-16	25	1	-16	25,4	1-1/4	122	71	74	54
1XN78-20-20	32	1-1/4	-20	31,8	1-1/4	172	108	77	54
1XN78-24-20	32	1-1/4	-20	31,8	1-1/2	172	107	77	64
1XN78-24-24	40	1-1/2	-24	38,1	1-1/2	166	103	106	64

Fittings with standard O-ring seals can be used for temperatures from -30 °C up to +105 °C.
 Find O-rings in section E. Special O-rings are available on request.
 Find SAE flange halves and O-rings in section E.
 Material: steel chromium(VI) free plated

Information about standard products or non-standard products can be found in the current price list.
 Dimensions shown may be changed at any time without prior notice.





JC – Female ORFS – Swivel – Straight – Short

ISO 12151-1-SWSA – SAE J516 – ORFS



Approved fitting series for hose types:



XXXX.XX.XX Part Number 	 Hose I.D.				 Thread UNF	A mm	B mm	 H mm	 W mm
	DN	Inch	Size	mm					
1JC78-12-12-SM	20	3/4	-12	19,1	1-3/16x12	81	33	30	36
1JC78-20-20-SM	32	1.1/4	-20	31,8	1-11/16x12	106	42	46	50

Material: steel chromium(VI) free plated
SM: Metric Hexagon

Information about standard products or non-standard products can be found in the current price list.
Dimensions shown may be changed at any time without prior notice.

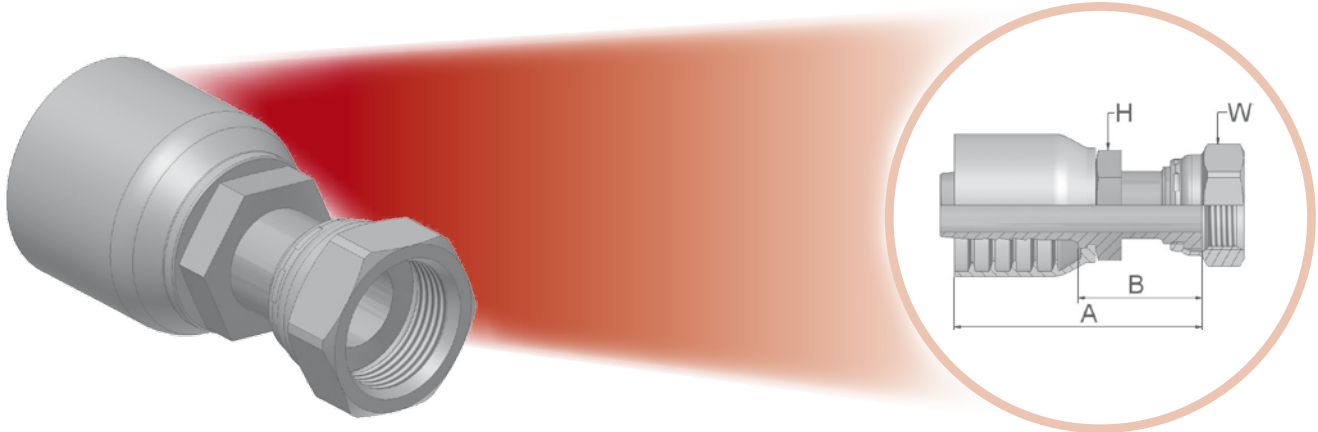

JS - ORFS Swivel Female (Long)

ISO 12151-1-SWSB – SAE J516 – ORFS



Approved fitting series for hose types:



XXXX-XX-XX Part Number 	 Hose I.D.				 Thread UNF	A	B	H	W
	DN	Inch	Size	mm		mm	mm	mm	mm
1JS78-12-12-SM	20	3/4	-12	19,1	1-3/16x12	98	50	30	36
1JS78-16-16-SM	25	1	-16	25,4	1-7/16x12	103	52	36	41
1JS78-20-16-SM	25	1	-16	25,4	1-11/16x12	114	64	41	50
1JS78-20-20-SM	32	1.1/4	-20	31,8	1-11/16x12	118	54	46	50
1JS78-24-24-SM	40	1-1/2	-24	38,1	2x12	120	57	50	60

Material: steel chromium(VI) free plated
SM: Metric Hexagon

Information about standard products or non-standard products can be found in the current price list.
Dimensions shown may be changed at any time without prior notice.



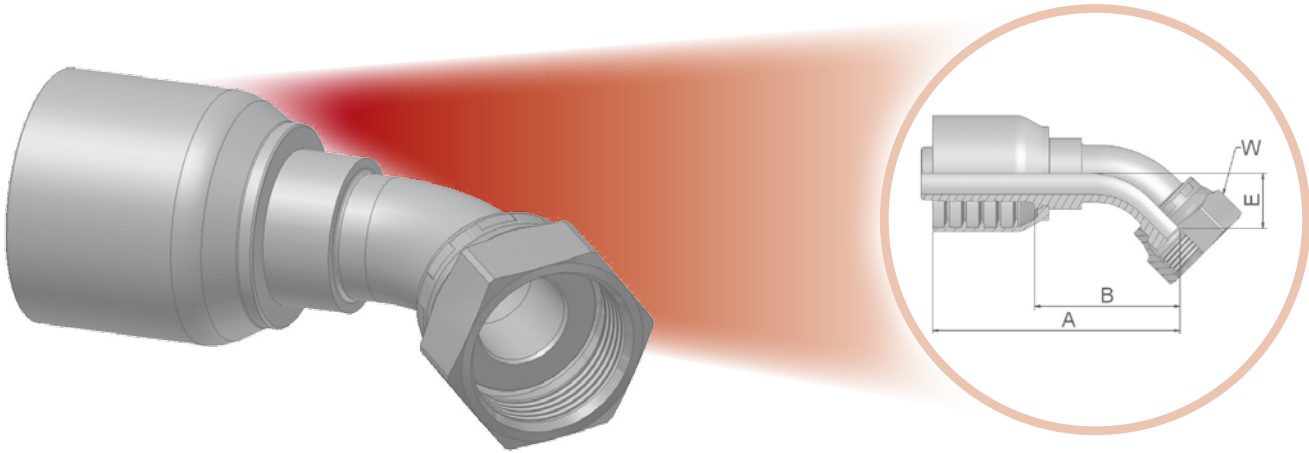

J7 - Female ORFS - Swivel - 45° Elbow - ISO 12151-1 - SWE 45°

ISO 12151-1-SWE45 - SAE J516 - ORFS 45°



Approved fitting series for hose types:



XXXX-XX-XX Part Number 	 Hose I.D.				 Thread UNF	A	B	E	 H
	DN	Inch	Size	mm					
1J778-12-12-SM	20	3/4	-12	19,1	1-3/16x12	105	57	21	36
1J778-16-16-SM	25	1	-16	25,4	1-7/16x12	119	69	24	41
1J778-20-20-SM	32	1.1/4	-20	31,8	1-11/16x12	154	90	30	50

Material: steel chromium(VI) free plated
SM: Metric Hexagon

Information about standard products or non-standard products can be found in the current price list.
Dimensions shown may be changed at any time without prior notice.



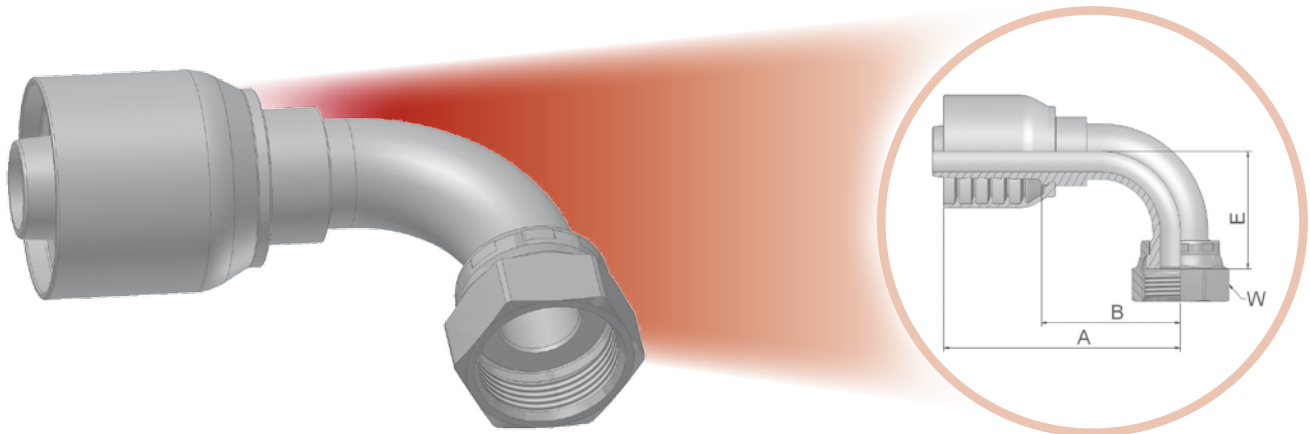

J9 – Female ORFS – Swivel – 90° Elbow – Short Drop

ISO 12151-1-SWES – SAE J516 – ORFS 90°



Approved fitting series for hose types:



XXXX-XX-XX Part Number 	 Hose I.D.				 Thread UNF	A	B	E	 W
	DN	Inch	Size	mm					
1J978-12-12-SM	20	3/4	-12	19,1	1-3/16x12	101	53	48	36
1J978-16-12-SM	20	3/4	-12	19,1	1-7/16x12	114	66	56	41
1J978-16-16-SM	25	1	-16	25,4	1-7/16x12	120	69	56	41
1J978-20-16-SM	25	1	-16	25,4	1-11/16x12	127	77	64	50
1J978-20-20-SM	32	1.1/4	-20	31,8	1-11/16-12	151	87	69	50
1J978-24-20-SM	32	1-1/4	-20	31,8	2x12	151	87	70	60

Material: steel chromium(VI) free plated
SM: Metric Hexagon

Information about standard products or non-standard products can be found in the current price list.
Dimensions shown may be changed at any time without prior notice.



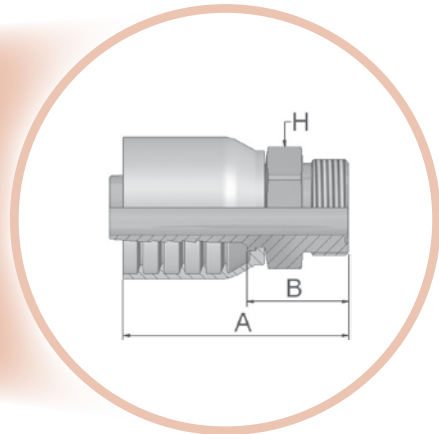
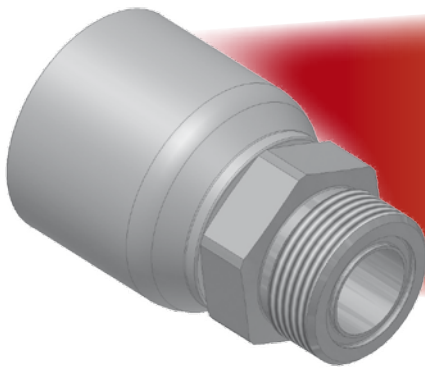

JM- ORFS Male

ISO 12151-1-S – SAE J516



Approved fitting series for hose types:



























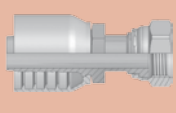
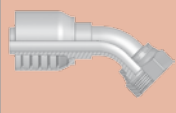
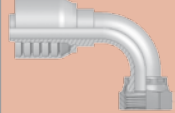



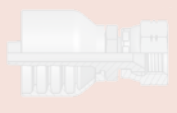



XXXX-XX-XX Part Number 	Hose I.D. 				Thread UNF 	A mm	B mm	W mm 
	DN	Inch	Size	mm				
1JM78-16-16-SM	25	1	-16	25,4	1-7/16x12	93	42	41
1JM78-20-16-SM	25	1	-16	25,4	1-11/16x12	89	39	46
1JM78-20-20-SM	32	1-1/4	-20	31,8	1-11/16x12	106	42	46
1JM78-24-20-SM	32	1-1/4	-20	31,8	2x12	108	44	55













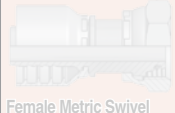



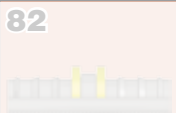

JM fittings are supplied without O-ring.
Find O-rings in section E. Special O-rings are available on request.
Material: steel chromium(VI) free plated
SM: Metric Hexagon

Information about standard products or non-standard products can be found in the current price list.
Dimensions shown may be changed at any time without prior notice.

Fittings Overview 79 Series

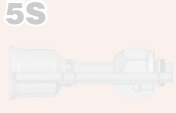
DIN	CA  DKOL	CE  DKOL 45°	CF  DKOL 90°	D0  CEL	C0  DKM or DKLL	C3  DKL	C4  DKL 45°	
	C5  DKL 90°	1D  BEL	DD  BEL 45°	5D  BEL 90°	C9 Df-1  DKOS	0C Df-2  DKOS 45°	1C Df-3  DKOS 90°	
	D2  CES	C6  DKS	3D  BES	49  Metric Banjo	9B  Swivel Female 45° Elbow	9C  Swivel Female 90° Elbow		
BSP	92  DKR	B1  DKR 45°	B2  DKR 90°	B4  DKR 90° (Compact)	EA  DKOR	EB  DKOR 45°	EC  DKOR 90°	
	D9  AGR	91  AGR-K	B5  Female BSP Parallel Pipe - Swivel (Flat Seat)	34  Standpipe				
SAE	01  AGN	02  Female NPTF Pipe Rigid - Straight	03  AGJ	04  Male SAE 45° - Rigid	05  Male SAE Straight Thread with O-ring - Rigid	06 68  DKJ	08  AGS	
	13  Male NPTF Pipe Swivel	33  Male JIC 37° - Rigid	37 3V  DKJ 45°	39 3W  DKJ 90°	41 3Y  DKJ 90° L	L9  DKJ 90° M	93  Female JIC 37° - Swivel (Block Type)	
Flange	15 4A  SFL	16  SFL 22.5°	17 4F  SFL 45°	19 4N  SFL 90°	6A Df-4  SFS	6F Df-5  SFS 45°	6N Df-6  SFS 90°	
	89  SFL 90° - long	XA  Caterpillar Flange Head	XF  Caterpillar Flange Head 45°	XG  Caterpillar Flange Head 60°	XN  Caterpillar Flange Head 90°			

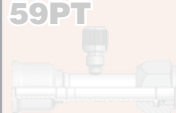
ORFS	JC  ORFS - short	JS Df-7  ORFS - long	J7 Df-8  ORFS 45°	J9 Df-9  ORFS Female 90°	J1  ORFS 90° - extra long	J5  ORFS 90° - long	JM  ORFS Male
	JD  Male ORFS – Bulkhead with Locknut (with O-ring)						
JIS	FU  GUI	GU  GUO	MU  Female Metric Swivel – (30° Flare)	MZ  Female Metric Swivel – (30° Flare)	UT  Male BSP Taper Pipe Rigid – (60° Cone)		
	FG  Male Rigid Gas Series - (24° Cone)	F2  Female Swivel Gas Series	F4  Female Swivel Gas Series - (Ball Nose)	F6  Male Metric (24° Cone)	F9  Swivel Female Metric (Ball Nose)	FA  Metric Male for Agriculture Valves	
High Pressure Cleaning	CW  Power Cleaner Connection	PW  Male Kärcher Metric Cleaning Hose Fitting – Rigid	NW  Female Kärcher Metric Cleaning Hose Fitting – (New Design)				

others	XU  Female Metric Swivel – (30° Flare)	XY  Female Metric Swivel – (30° Flare)	DK  Male Metric L – Rigid Bulkhead with Locknut (24° Cone)	DX  Female Metric Swivel (M27x2) O-ring – Light Series	FF  Metru-Lok Swivel Female	AF  Male BSP Parallel Pipe Rigid – Straight (with O-ring Seal)	NM  Male BSP Parallel Pipe – L Series – Rigid Straight – ED-Seal
	YW  Male Standpipe – Rigid – Straight – A-Lok	VW121  BSP Swivel Female	82  Push-Lok Union	DP  Metric Swivel Female Tee / Male Stud	DR  Metric Swivel Female Tee	5C  60° Cone Swivel Female	6C  60° Cone Swivel Female – 45° Elbow
	7C  60° Cone Swivel Female – 90° Elbow	5S  Female Tube O-ring Swivel – Short Pilot	5H  Female Tube O-ring Swivel – 45° Elbow Short Pilot	5T  Female Tube O-ring Swivel – 90° Elbow Short Pilot	59PT  Male Tube O-ring Swivel – Long Pilot Charge Port at 180° for R134a	5LPT  Female Tube O-ring Swivel – 90° Elbow Long Pilot Charge Port at 180° for R134a	T1  Male Refrigerant Tube Mender – Straight (with Nut and Ferrule)



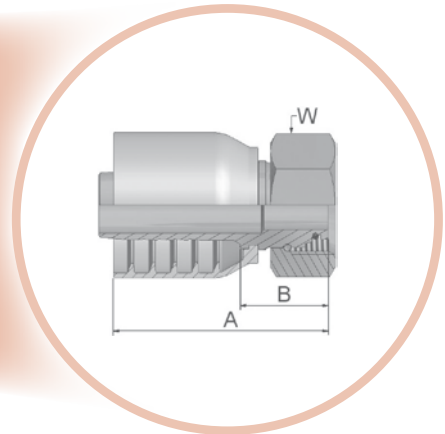
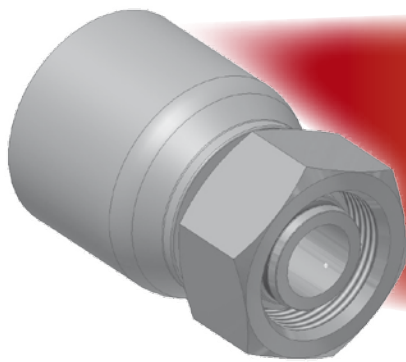

C9 – Female Metric 24° – Heavy Series with O-ring – Swivel – Straight

ISO 12151-2-SWS-S – DKOS



Approved fitting series for hose types:



XXXX.XX.XX Part Number 	 Hose I.D.				 Thread metric	A	B	 W
	DN	Inch	Size	mm				
1C979-25-12	20	3/4	-12	19,1	M36x2	87	32	46
1C979-30-16	25	1	-16	25,4	M42x2	95	36	50
1C979-38-20°	32	1-1/4	-20	31,8	M52x2	111	40	60

Fittings with standard O-ring seals can be used for temperatures from -30 °C up to +105 °C.

Find O-rings in section E. Special O-rings are available on request.

° Attention: Hose assembly pressure is reduced; see page Ab-3

Material: steel chromium(VI) free plated

Information about standard products or non-standard products can be found in the current price list.
Dimensions shown may be changed at any time without prior notice.



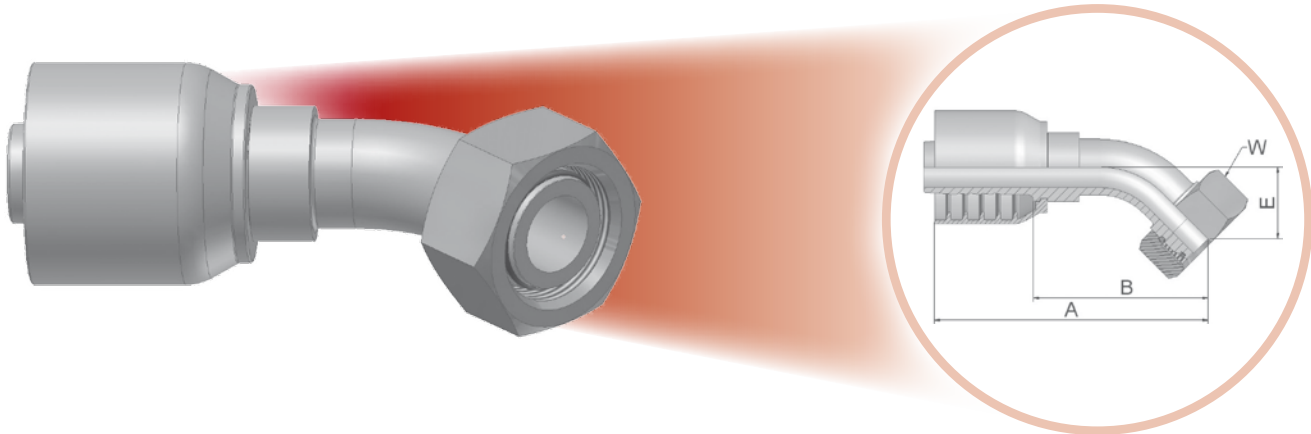

OC – Female Metric 24° – Heavy Series with O-ring – Swivel – 45° Elbow

ISO 12151-2-SWE45-S – DKOS 45°



Approved fitting series for hose types:



XXXX-XX-XX Part Number 	Hose I.D. 				Thread metric 	A	B	E	W 
	DN	Inch	Size	mm					
10C79-25-12	20	3/4	-12	19,1	M36x2	120	64	29	46
10C79-30-16	25	1	-16	25,4	M42x2	140	81	34	50

Fittings with standard O-ring seals can be used for temperatures from -30 °C up to +105 °C.
Find O-rings in section E. Special O-rings are available on request.
Material: steel chromium(VI) free plated

Information about standard products or non-standard products can be found in the current price list.
Dimensions shown may be changed at any time without prior notice.



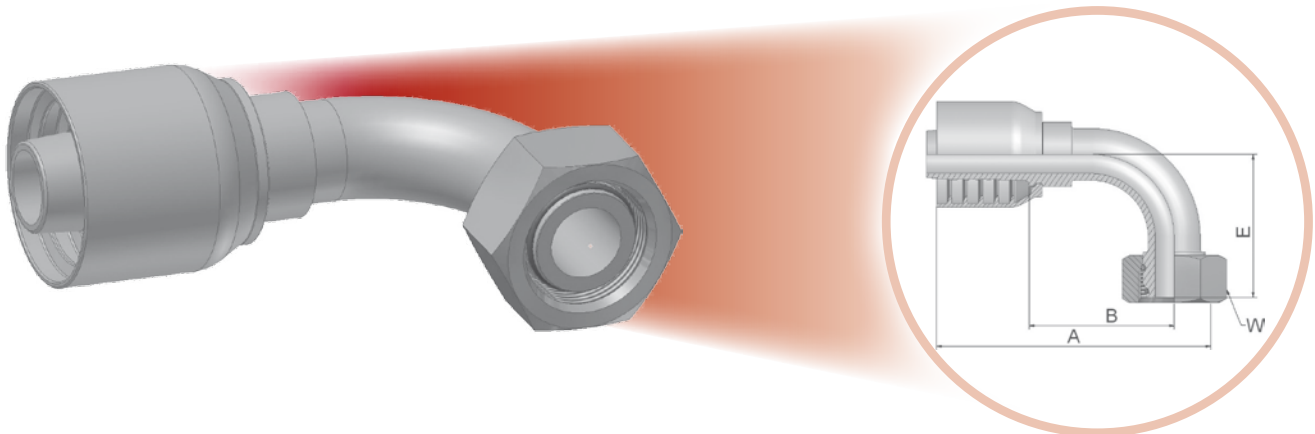

1C – Female Metric 24° – Heavy Series with O-ring – Swivel – 90° Elbow

ISO 12151-2 -SWE-S – DKOS 90°



Approved fitting series for hose types:



XXXX-XX-XX Part Number 	 Hose I.D.				 Thread metric	A	B	E	 W
	DN	Inch	Size	mm					
11C79-25-12	20	3/4	-12	19,1	M36x2	109	53	59	46
11C79-30-16	25	1	-16	25,4	M42x2	130	72	73	50
11C79-38-20°	32	1.1/4	-20	31,8	M52x2	161	89	74	60

Fittings with standard O-ring seals can be used for temperatures from -30 °C up to +105 °C.

Find O-rings in section E. Special O-rings are available on request.

° Attention: Hose assembly pressure is reduced; see page Ab-3

Material: steel chromium(VI) free plated

Information about standard products or non-standard products can be found in the current price list.
Dimensions shown may be changed at any time without prior notice.

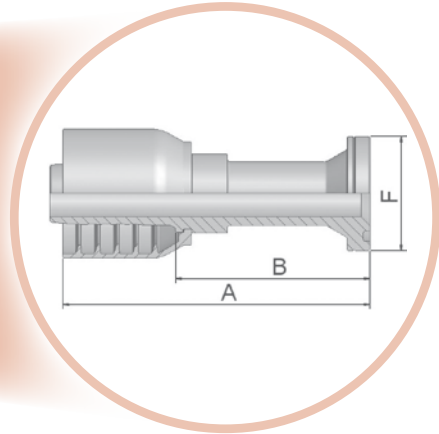
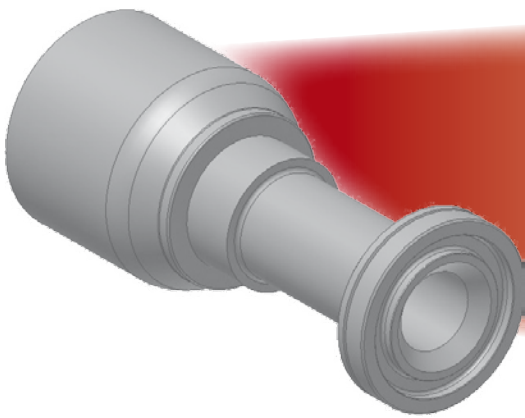

6A – SAE Code 62 – Flange – Straight

ISO 12151-3-S-S – SFS – 6000 psi



Approved fitting series for hose types:



XXXX-XX-XX Part Number 	 Hose I.D.				 End Connection	A mm	B mm	F mm
	DN	Inch	Size	mm				
16A79-12-12	20	3/4	-12	19,1	3/4	124	72	41
16A79-16-12	20	3/4	-12	19,1	1	99	46	48
16A79-12-16	25	1	-16	25,4	3/4	132	73	41
16A79-16-16	25	1	-16	25,4	1	139	84	48
16A79-20-16	25	1	-16	25,4	1-1/4	109	50	54
16A79-16-20	32	1.1/4	-20	31,8	1	152	81	48
16A79-20-20	32	1-1/4	-20	31,8	1-1/4	158	87	54
16A79-24-20	32	1-1/4	-20	31,8	1-1/2	128	57	64
16A79-20-24	40	1-1/2	-24	38,1	1-1/4	165	87	54
16A79-24-24	40	1-1/2	-24	38,1	1-1/2	181	104	64

Find SAE flange halves in section Eb.

Fittings with standard O-ring seals can be used for temperatures from -30 °C up to +105 °C.

Find O-rings in section E. Special O-rings are available on request.

Material: steel chromium(VI) free plated

Information about standard products or non-standard products can be found in the current price list.
Dimensions shown may be changed at any time without prior notice.

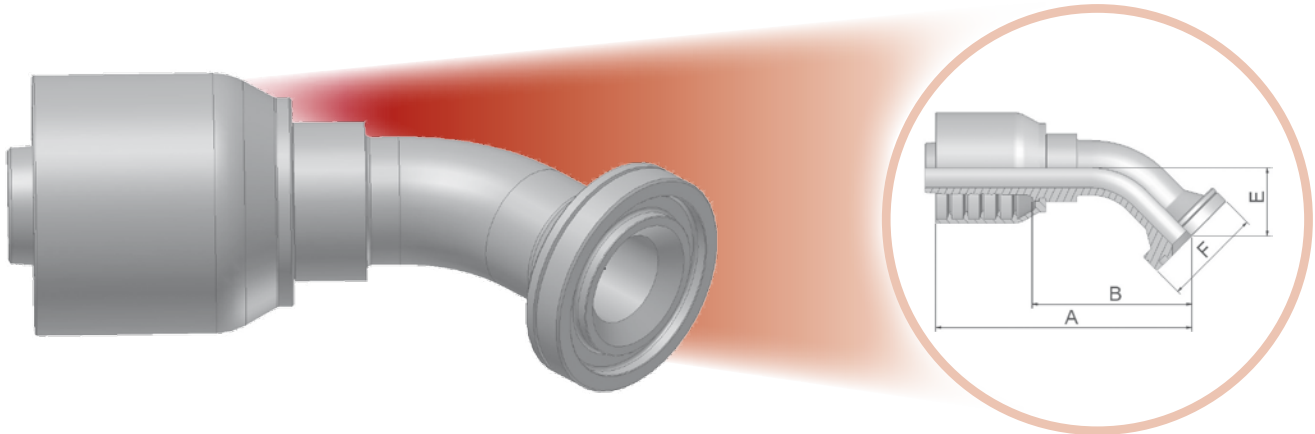

6F – SAE Flange 45° Elbow – Heavy Series

ISO 12151-3-E45-S – SFS 45° – 6000 psi



Approved fitting series for hose types:



XXXX-XX-XX Part Number 	Hose I.D. 				End Connection 	A	B	E	F
	DN	Inch	Size	mm					
16F79-12-12	20	3/4	-12	19,1	3/4	117	65	26	41
16F79-16-12	20	3/4	-12	19,1	1	117	65	26	48
16F79-12-16	25	1	-16	25,4	3/4	130	72	32	41
16F79-16-16	25	1	-16	25,4	1	137	79	32	48
16F79-20-16	25	1	-16	25,4	1-1/4	137	79	32	54
16F79-16-20	32	1-1/4	-20	31,8	1	161	89	38	48
16F79-20-20	32	1-1/4	-20	31,8	1-1/4	172	104	38	54
16F79-24-20	32	1-1/4	-20	31,8	1-1/2	172	101	38	64
16F79-24-24	40	1-1/2	-24	38,1	1-1/2	197	120	44	64

Find SAE flange halves in section Eb.
 Fittings with standard O-ring seals can be used for temperatures from -30 °C up to +105 °C.
 Find O-rings in section E. Special O-rings are available on request.
 Material: steel chromium(VI) free plated

Information about standard products or non-standard products can be found in the current price list.
 Dimensions shown may be changed at any time without prior notice.

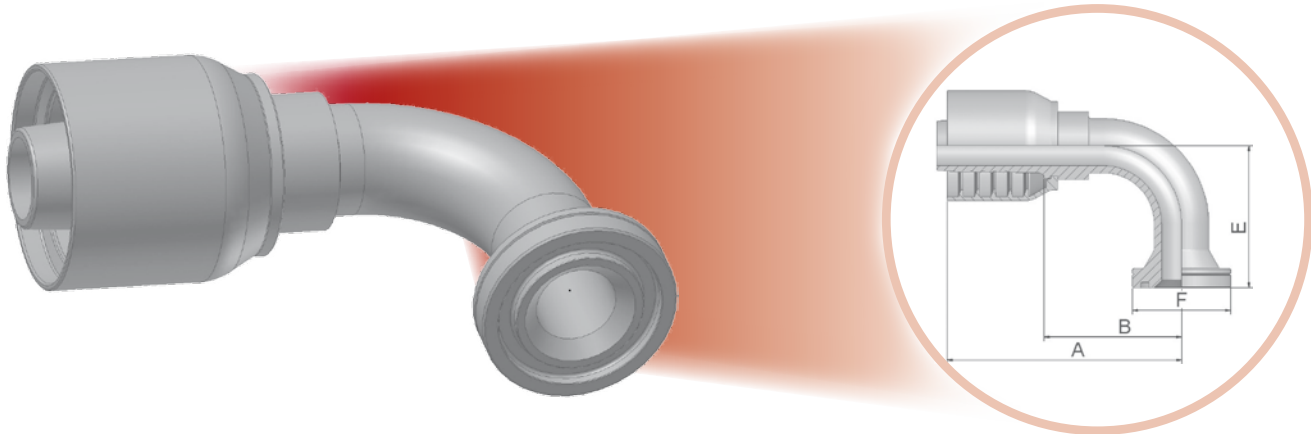

6N – SAE Code 62 Flange Head – 90° Elbow

ISO 12151-3-E90S-S – SFS 90°



Approved fitting series for hose types:



XXXX.XX.XX Part Number 	 Hose I.D.				 End Connection	A	B	E	F
	DN	Inch	Size	mm					
16N79-12-12	20	3/4	-12	19,1	3/4	108	56	58	41
16N79-16-12	20	3/4	-12	19,1	1	108	56	58	48
16N79-12-16	25	1	-16	25,4	3/4	116	58	70	41
16N79-16-16	25	1	-16	25,4	1	130	72	70	48
16N79-20-16	25	1	-16	25,4	1-1/4	126	71	70	54
16N79-16-20	32	1-1/4	-20	31,8	1	148	76	90	48
16N79-20-20	32	1-1/4	-20	31,8	1-1/4	161	89	90	54
16N79-24-20	32	1-1/4	-20	31,8	1-1/2	160	89	90	64
16N79-24-24	40	1-1/2	-24	38,1	1-1/2	185	108	104	64

Find SAE flange halves in section Eb.

Fittings with standard O-ring seals can be used for temperatures from -30 °C up to +105 °C.

Find O-rings in section E. Special O-rings are available on request.

Material: steel chromium(VI) free plated

Information about standard products or non-standard products can be found in the current price list.
Dimensions shown may be changed at any time without prior notice.



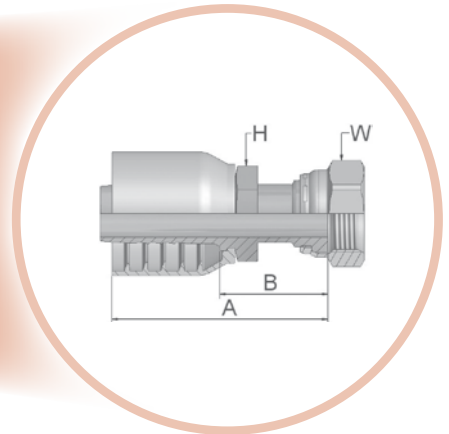
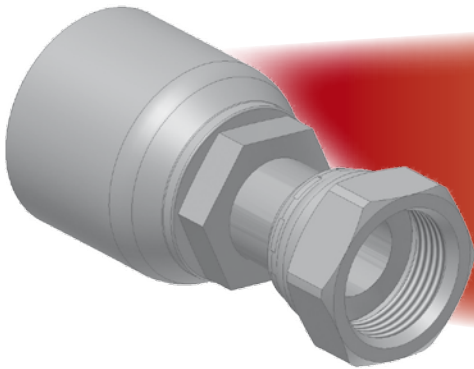

JS - ORFS Swivel Female (Long)

ISO 12151-1-SWSB – SAE J516 – ORFS



Approved fitting series for hose types:



XXXX-XX-XX Part Number 	 Hose I.D.				 Thread UNF	A	B	 H	 W
	DN	Inch	Size	mm					
1JS79-12-12	20	3/4	-12	19,1	1-3/16x12	101	49	1-1/8	1-3/8
1JS79-16-16-SM	25	1	-16	25,4	1-7/16x12	113	55	36	41
1JS79-20-16	25	1	-16	25,4	1-11/16x12	110	55	1-3/4	1-7/8
1JS79-20-20	32	1-1/4	-20	31,8	1-11/16x12	127	59	1-3/4	1-7/8
1JS79-24-24-SM	40	1-1/2	-24	38,1	2x12	134	57	50	60

Material: steel chromium(VI) free plated
SM: Metric Hexagon

Information about standard products or non-standard products can be found in the current price list.
Dimensions shown may be changed at any time without prior notice.



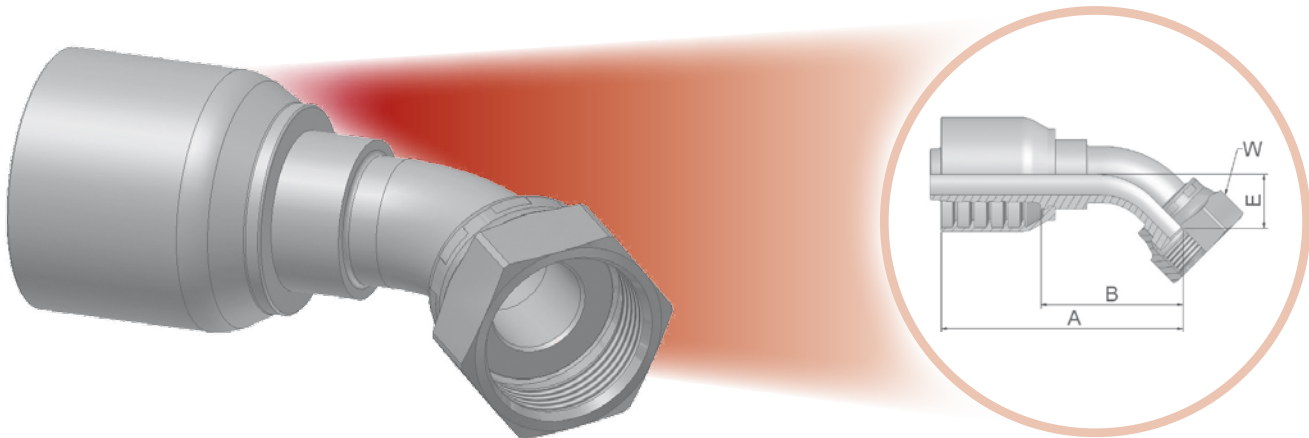

J7 - Female ORFS - Swivel - 45° Elbow

ISO 12151-1-SWE45 - SAE J516 - ORFS 45°



Approved fitting series for hose types:



XXXX-XX-XX Part Number 	 Hose I.D.				 Thread UNF	A	B	E	 W
	DN	Inch	Size	mm					
1J779-12-12-SM	20	3/4	-12	19,1	1-3/16x12	113	59	21	36
1J779-16-16-SM	25	1	-16	25,4	1-7/16x12	135	76	24	41
1J779-20-20	32	1-1/4	-20	31,8	1-11/16x12	156	89	25	1-7/8

Material: steel chromium(VI) free plated
SM: Metric Hexagon

Information about standard products or non-standard products can be found in the current price list.
Dimensions shown may be changed at any time without prior notice.



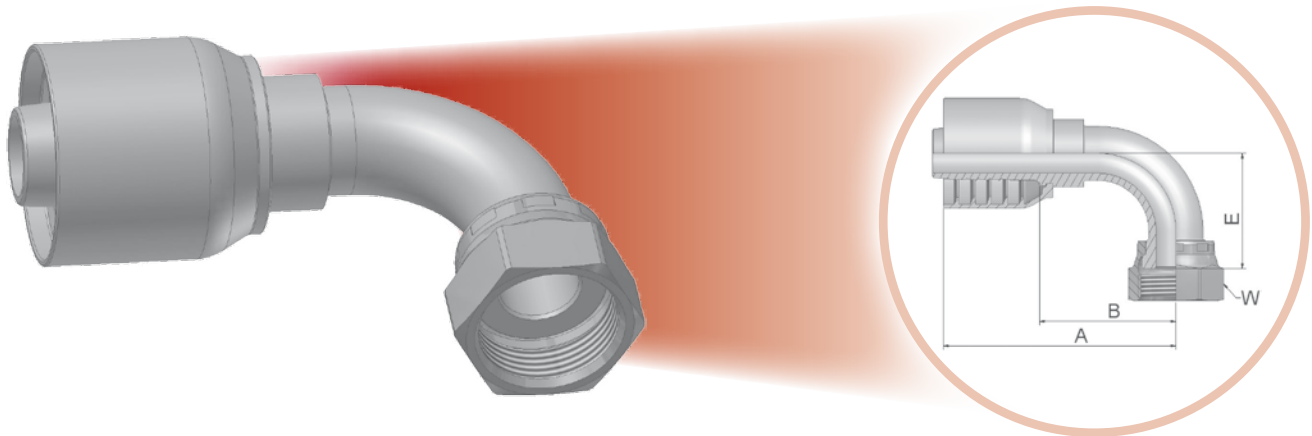

J9 – Female ORFS – Swivel – 90° Elbow – Short Drop

ISO 12151-1-SWES – SAE J516 – ORFS 90°



Approved fitting series for hose types:





























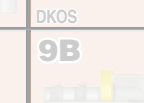
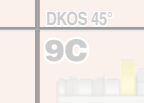
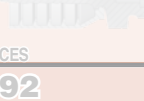

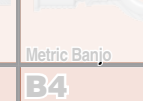
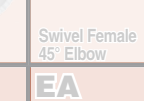
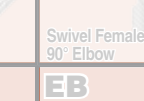
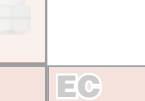

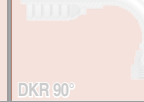





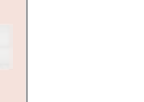







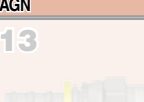

XXXX-XX-XX Part Number 	 Hose I.D.				 Thread UNF	A	B	E	 W
	DN	Inch	Size	mm		mm	mm	mm	mm / Inch
1J979-12-12-SM	20	3/4	-12	19,1	1-3/16x12	109	53	48	36
1J979-16-16	25	1	-16	25,4	1-7/16x12	126	71	56	1-5/8
1J979-20-20-SM	32	1-1/4	-20	31,8	1-11/16x12	160	89	69	50

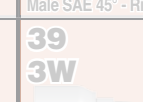
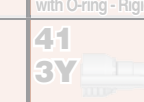

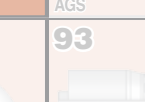
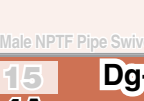









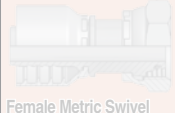



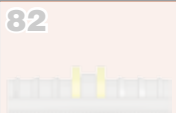

Material: steel chromium(VI) free plated
SM: Metric Hexagon

Information about standard products or non-standard products can be found in the current price list.
Dimensions shown may be changed at any time without prior notice.

Fittings Overview S6 Series

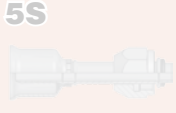
DIN	CA  DKOL	CE  DKOL 45°	CF  DKOL 90°	D0  CEL	C0  DKM or DKLL	C3  DKL	C4  DKL 45°	
	C5  DKL 90°	1D  BEL	DD  BEL 45°	5D  BEL 90°	C9  DKOS	0C  DKOS 45°	1C  DKOS 90°	
	D2  CES	C6  DKS	3D  BES	49  Metric Banjo	9B  Swivel Female 45° Elbow	9C  Swivel Female 90° Elbow		
	92  DKR	B1  DKR 45°	B2  DKR 90°	B4  DKR 90° (Compact)	EA  DKOR	EB  DKOR 45°	EC  DKOR 90°	
	D9  AGR	91  AGR-K	B5  Female BSP Parallel Pipe - Swivel (Flat Seat)	34  Standpipe				
	01  AGN	Dg-1  Female NPTF Pipe Rigid - Straight	03  AGJ	04  Male SAE 45° - Rigid	05  Male SAE Straight Thread with O-ring - Rigid	06  DKJ	Dg-2  AGS	
13  Male NPTF Pipe Swivel	33  Male JIC 37° - Rigid	37 3V  DKJ 45°	39 3W  DKJ 90°	41 3Y  DKJ 90° L	L9  DKJ 90° M	93  Female JIC 37° - Swivel (Block Type)		
15 4A  SFL	Dg-3 16  SFL 22.5°	17 4F  SFL 45°	Dg-4 19 4N  SFL 90°	Dg-5 6A  SFS	Dg-6 6F  SFS 45°	Dg-7 6N  SFS 90°	Dg-8	
89  SFL 90° - long	XA  Caterpillar Flange Head	XF  Caterpillar Flange Head 45°	XG  Caterpillar Flange Head 60°	XN  Caterpillar Flange Head 90°				

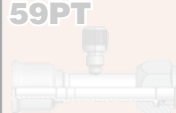
ORFS	JC  ORFS - short	JS  ORFS - long	J7  ORFS 45°	J9  ORFS Female 90°	J1  ORFS 90° - extra long	J5  ORFS 90° - long	JM  ORFS Male
	JD  Male ORFS – Bulkhead with Locknut (with O-ring)						
JIS	FU  GUI	GU  GUO	MU  Female Metric Swivel – (30° Flare)	MZ  Female Metric Swivel – (30° Flare)	UT  Male BSP Taper Pipe Rigid – (60° Cone)		
	French Standard	FG  Male Rigid Gas Series - (24° Cone)	F2  Female Swivel Gas Series	F4  Female Swivel Gas Series - (Ball Nose)	F6  Male Metric (24° Cone)	F9  Swivel Female Metric (Ball Nose)	FA  Metric Male for Agriculture Valves
High Pressure Cleaning		CW  Power Cleaner Connection	PW  Male Kärcher Metric Cleaning Hose Fitting – Rigid	NW  Female Kärcher Metric Cleaning Hose Fitting Swivel – (New Design)			

others	XU  Female Metric Swivel – (30° Flare)	XY  Female Metric Swivel – (30° Flare)	DK  Male Metric L – Rigid Bulkhead with Locknut (24° Cone)	DX  Female Metric Swivel (M27x2) O-ring – Light Series	FF  Metru-Lok Swivel Female	AF  Male BSP Parallel Pipe Rigid – Straight (with O-ring Seal)	NM  Male BSP Parallel Pipe – L Series – Rigid Straight – ED-Seal	
	YW  Male Standpipe – Rigid – Straight – A-Lok	VW121  BSP Swivel Female	82  Push-Lok Union	DP  Metric Swivel Female Tee / Male Stud	DR  Metric Swivel Female Tee	5C  60° Cone Swivel Female	6C  60° Cone Swivel Female – 45° Elbow	
	7C  60° Cone Swivel Female – 90° Elbow	5S  Female Tube O-ring Swivel – Short Pilot	5H  Female Tube O-ring Swivel – 45° Elbow Short Pilot	5T  Female Tube O-ring Swivel 90° Elbow Short Pilot	59PT  Male Tube O-ring Swivel – Long Pilot Charge Port at 180° for R134a	5LPT  Female Tube O-ring Swivel – 90° Elbow Long Pilot Charge Port at 180° for R134a	T1  Male Refrigerant Tube Mender – Straight (with Nut and Ferrule)	



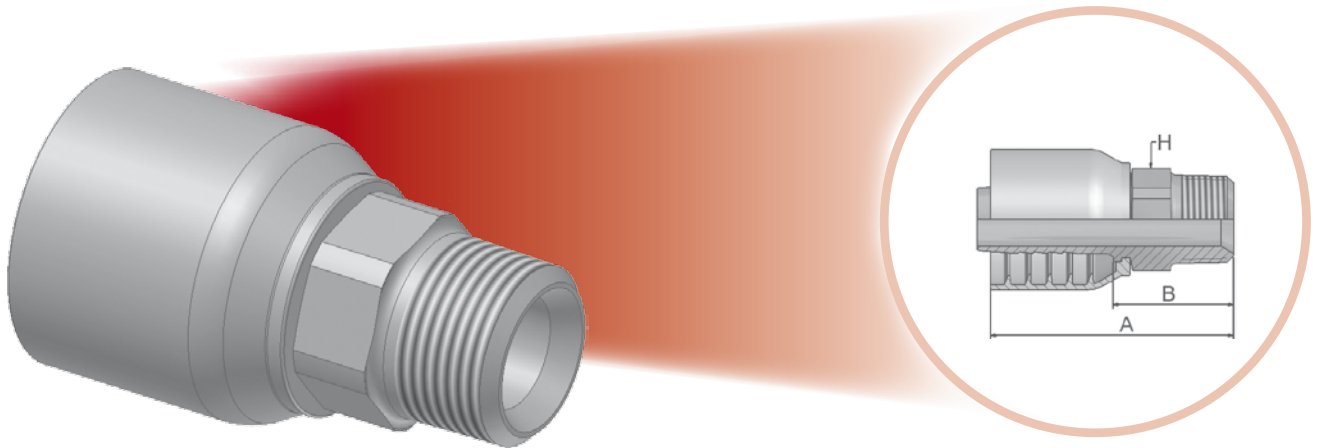

01 - Male NPTF Pipe - Rigid - Straight

SAE J476A - J516 - AGN



Approved fitting series for hose types:



XXXX-XX-XX Part Number 	 Hose I.D.				 Thread NPTF	A mm	B mm	 H Inch
	DN	Inch	Size	mm				
101S6-32-32	50	2	-32	50,8	2x11-1/2	150	62	2-1/2

Material: steel chromium(VI) free plated

Information about standard products or non-standard products can be found in the current price list. Dimensions shown may be changed at any time without prior notice.



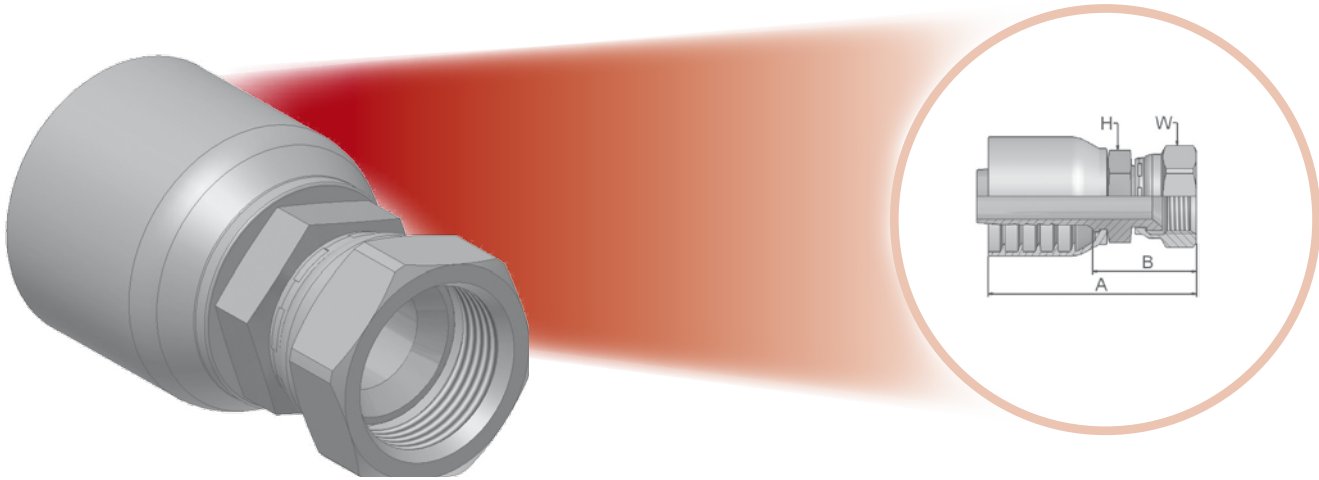

06 - Female JIC 37° Swivel - Straight

ISO12151-5-SWS - DKJ



Approved fitting series for hose types:



XXXX.XX.XX Part Number 	 Hose I.D.				 Thread UNF	A	B	 H	 W
	DN	Inch	Size	mm		mm	mm	Inch	Inch
106S6-32-32	50	2	-32	50,8	2-1/2x12	166	78	2/1/2	2-7/8

Material: steel chromium(VI) free plated

Information about standard products or non-standard products can be found in the current price list. Dimensions shown may be changed at any time without prior notice.

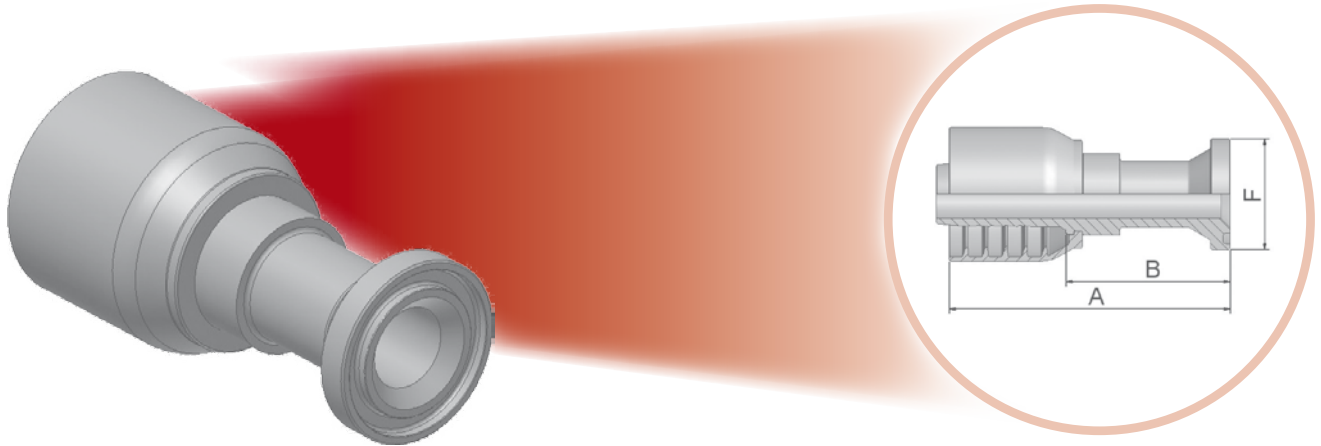

4A – 5000 psi SAE Code 61 Flange – Straight

ISO 12151-3-SL – SFL



Approved fitting series for hose types:



XXXX-XX-XX Part Number 	Hose I.D. 				End Connection 	A	B	F
	DN	Inch	Size	mm				
14AS6-32-32	50	2	-32	50,8	2	171	83	71

Find SAE flange halves in section Eb.

Fittings with standard O-ring seals can be used for temperatures from -30 °C up to +105 °C.

Find O-rings in section E. Special O-rings are available on request.

Material: steel chromium(VI) free plated

Information about standard products or non-standard products can be found in the current price list.
Dimensions shown may be changed at any time without prior notice.

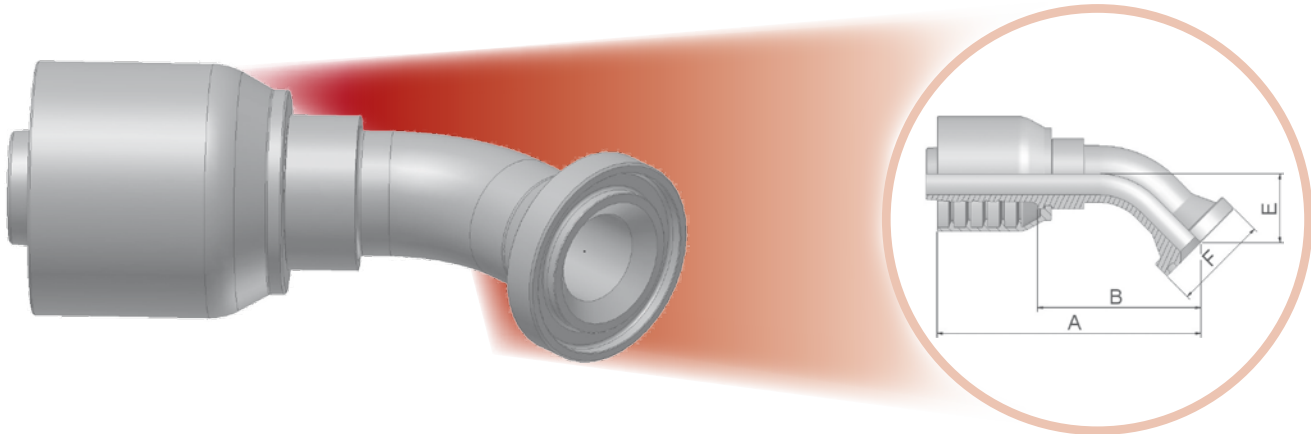

4F – 5000 psi SAE Code 61 Flange – 45° Elbow

ISO 12151-3-E45S-L – SFL 45°



Approved fitting series for hose types:



XXXX.XX.XX Part Number 	 Hose I.D.				 End Connection	A	B	E	F
	DN	Inch	Size	mm		mm	mm	mm	mm
14FS6-32-32	50	2	-32	50,8	2	229	141	56	71

Find SAE flange halves in section Eb.
 Fittings with standard O-ring seals can be used for temperatures from -30 °C up to +105 °C.
 Find O-rings in section E. Special O-rings are available on request.
 Material: steel chromium(VI) free plated

Information about standard products or non-standard products can be found in the current price list.
 Dimensions shown may be changed at any time without prior notice.

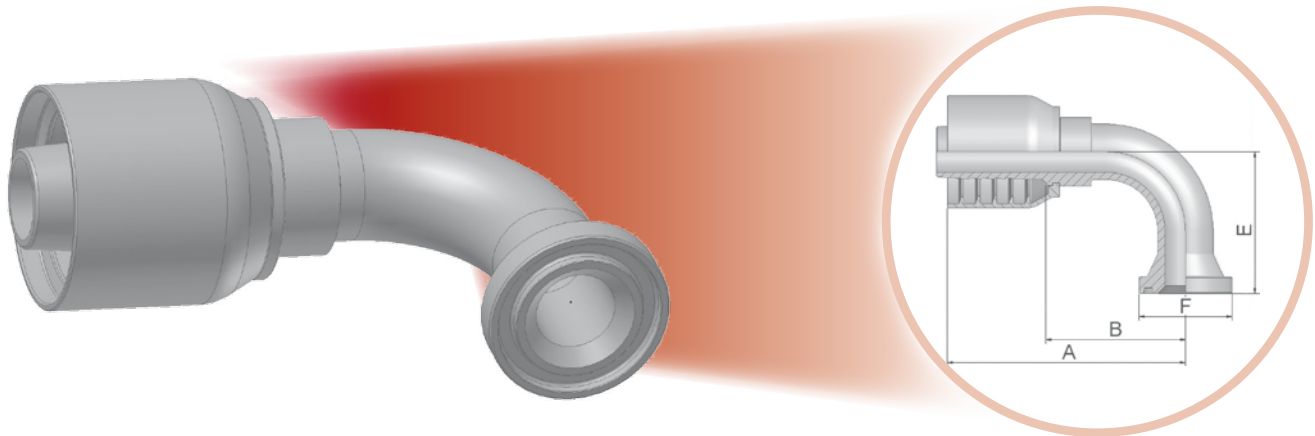

4N – 5000 psi SAE Code 61 Flange – 90° Elbow

ISO 12151-3-E90ML – SFL 90°



Approved fitting series for hose types:



XXXX-XX-XX Part Number 	 Hose I.D.				 End Connection	A	B	E	F
	DN	Inch	Size	mm		mm	mm	mm	mm
14NS6-32-32	50	2	-32	50,8	2	214	126	138	71

Find SAE flange halves in section Eb.
 Fittings with standard O-ring seals can be used for temperatures from -30 °C up to +105 °C.
 Find O-rings in section E. Special O-rings are available on request.
 Material: steel chromium(VI) free plated

Information about standard products or non-standard products can be found in the current price list.
 Dimensions shown may be changed at any time without prior notice.

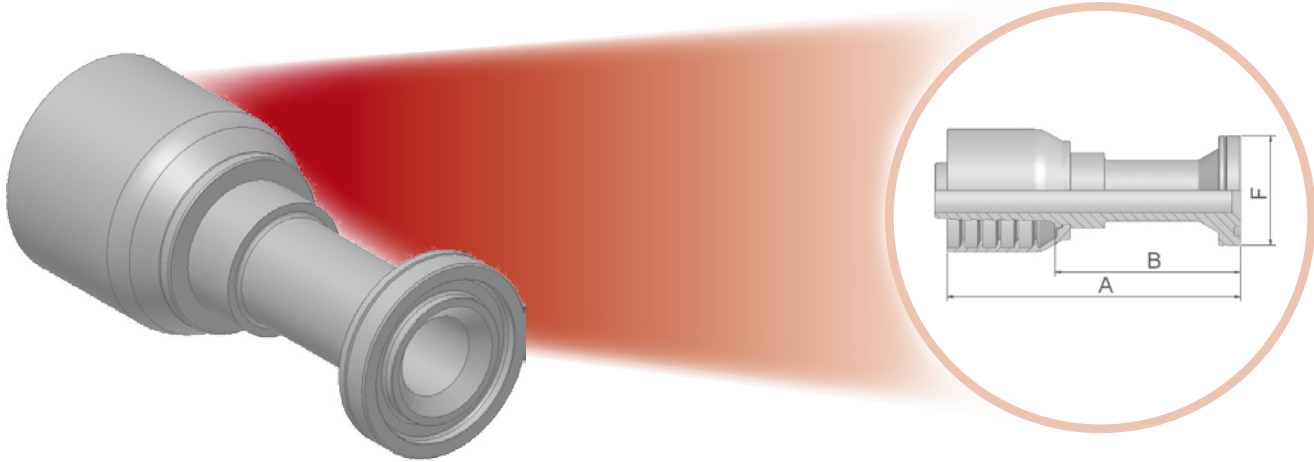

6A – SAE Code 62 – Flange – Straight

ISO 12151-3-S-S – SFS – 6000 psi



Approved fitting series for hose types:



XXXX-XX-XX Part Number 	 Hose I.D.				 End Connection	A	B	F
	DN	Inch	Size	mm				
16AS6-32-32	50	2	-32	50,8	2	209	121	79

Find SAE flange halves in section Eb.
 Fittings with standard O-ring seals can be used for temperatures from -30 °C up to +105 °C.
 Find O-rings in section E. Special O-rings are available on request.
 Material: steel chromium(VI) free plated

Information about standard products or non-standard products can be found in the current price list.
 Dimensions shown may be changed at any time without prior notice.

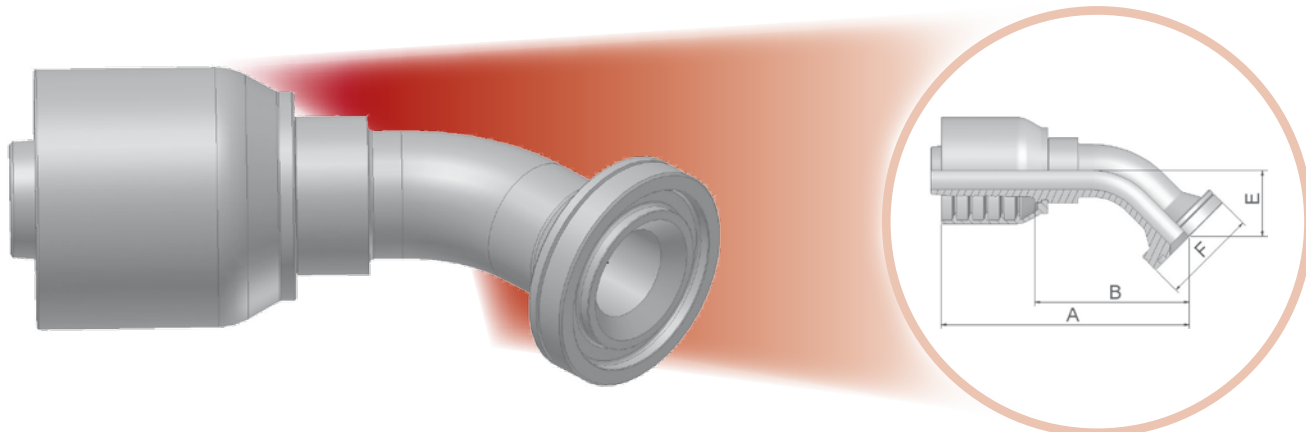

6F – SAE Flange 45° Elbow – Heavy Series

ISO 12151-3-E45-S – SFS 45° – 6000 psi



Approved fitting series for hose types:



XXXX-XX-XX Part Number 	 Hose I.D.				 End Connection	A	B	E	F
	DN	Inch	Size	mm		mm	mm	mm	mm
16FS6-32-32	50	2	-32	50,8	2	229	141	56	79

Find SAE flange halves in section Eb.
 Fittings with standard O-ring seals can be used for temperatures from -30 °C up to +105 °C.
 Find O-rings in section E. Special O-rings are available on request.
 Material: steel chromium(VI) free plated

Information about standard products or non-standard products can be found in the current price list.
 Dimensions shown may be changed at any time without prior notice.

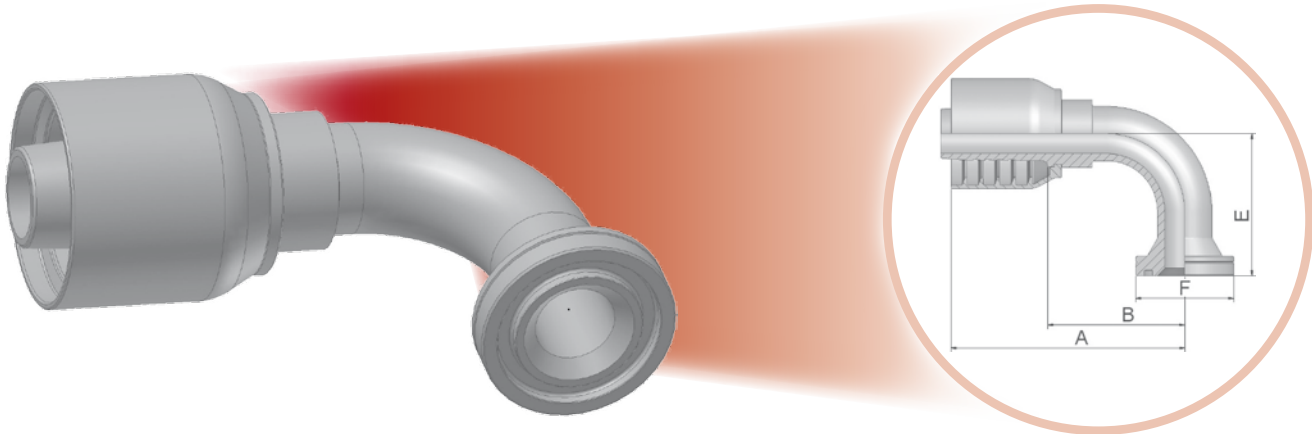

6N – SAE Code 62 Flange Head – 90° Elbow

ISO 12151-3-E-S – SFS 90° – 6000 psi



Approved fitting series for hose types:



XXXX-XX-XX Part Number 	 Hose I.D.				 End Connection	A	B	E	F
	DN	Inch	Size	mm		mm	mm	mm	mm
16NS6-32-32	50	2	-32	50,8	2	214	126	138	79

Find SAE flange halves in section Eb.
 Fittings with standard O-ring seals can be used for temperatures from -30 °C up to +105 °C.
 Find O-rings in section E. Special O-rings are available on request.
 Material: steel chromium(VI) free plated

Information about standard products or non-standard products can be found in the current price list.
 Dimensions shown may be changed at any time without prior notice.



aerospace
climate control
electromechanical
filtration
fluid & gas handling
hydraulics
pneumatics
process control
sealing & shielding



Hydraulic Hose, Fittings and Equipment

Machines, Tooling, Accessories



ENGINEERING YOUR SUCCESS.

Hydraulic Hose Assembly Workshop Equipment

- meeting the demands for professional hose assembly manufacture

Hose assemblies must be manufactured in conformity with all the relevant EN/ISO standards and with the requirements of various trade associations. Hose Products Division Europe has selected and developed a complete range of machines and tooling to ensure effective and safe production of hose assemblies. This can be achieved only when equipment designed for the purpose is used.

The Parker range of Parkrimp machines and its crimping machine technology are recognised industry-wide as the easiest and most accurate crimping system available.

The programme includes the right tools for cutting hoses and for the marking and cleaning of hose assemblies; also, last but not least, appropriate hose assembly testing equipment, all of which allows the production of ready-to-install hose assemblies.

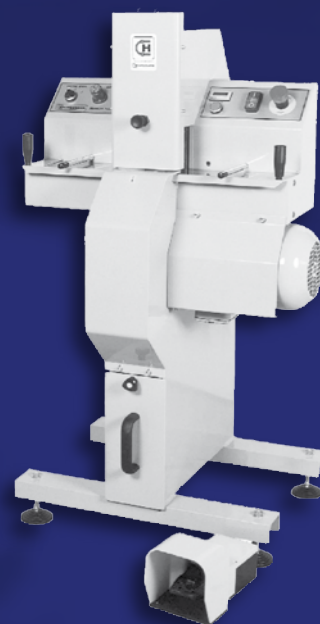

Parkrimp® No-Skive

The system for fast and leak-free assemblies

- No skiving tool needed
- No need to remove the cover
- Crimps one piece fittings
- Parkalign positions the fittings in the die perfectly every time
- Quick and easy: no gauges to set on the machine
- Portable machines for field repair
- Meets EN safety regulations



Parkalign®
Parker's exclusive Parkalign® positions the fitting in the dies perfectly every time.



Parker's colour-coded die sets

No loose parts to mismatch or misplace – die set segments linked together. Die sets provide 360° evenly applied crimping forces for an ideal crimp result.

The perfect match

The complete system from one source. *No-Skive* hose, *No-Skive* fitting and crimping machine with world-wide guarantee and availability.



Index

Machines

MiniKrimp	Ea-1
KarryKrimp® 1 – Crimping Press 82CE-061	Ea-2
KarryKrimp® 2 – Crimping Press 85CE-061	Ea-3
PHastkrimp® – Crimping Press 89CE-061	Ea-4
Parkrimp® 2 – Crimping Press 83CE	Ea-5
Accessories for KarryKrimp® 1 and KarryKrimp® 2	Ea-6
Parkrimp® – Die Sets	Ea-7
Hose Cut-Off Machine EM 10.P	Ea-8
Hose Cut-Off Machine TH 3-2-12VDC	Ea-9
Hose Cut-Off Machine TH 3-2	Ea-10
Hose Cut-Off Machine TH 3-3	Ea-11
Hose Cut-Off Machine TH 3-13	Ea-12
Hose Cut-Off Machine TH 3-14	Ea-13
Hose Cut-Off Machine TH 3-15	Ea-14
Marking Machines TH4-7, TH4-8	Ea-15
Hand Marking Tool TH4-4 U	Ea-16
Cleaning Machine TH6-6	Ea-17
Cleaning System TH6-7	Ea-17
Parker “Hoze-Oil”	Ea-18
Assembly Tool	Ea-18
Push-Lok® Assembly Oil H896137	Ea-18
OilOn TH11-3	Ea-18
Hose Assembly Test Bench TH5-3	Ea-19
HoseReel TH7-12	Ea-20
HoseReel TH7-13	Ea-20
HoseReel TH7-14	Ea-21
HoseReel TH7-15	Ea-21

Accessories

Flange Half	Eb-1
O-rings	Eb-2–Eb-3
Worm Drive Hose Clamps with Slotted Hex Head Screw.....	Eb-4–Eb-5
Banjo Bolt	Eb-6
SG – Spring Guard	Eb-7
AG – Armour Guard	Eb-8
AS/PS – Partek® Nylon Protective Sleeve	Eb-9
FS-F – Fire Sleeves	Eb-10
HG/PG – PolyGuard-Hose Protector and ParKoil-Hose Protector	Eb-11
WKS – Rubber Hand Grip	Eb-12

Assembly Instruction

KarryKrimp® 1	Ec-1
KarryKrimp® 2 and PHastkrimp®	Ec-2
Parkrimp® 2	Ec-3

Crimp Chart

MiniKrimp® – 26, 46 and 48 Series	Ed-1–Ed-2
KarryKrimp® 1 – 26, 46 and 48 Series	Ed-3–Ed-4
KarryKrimp® 2 and PHastkrimp® – 26, 46, 48, 70, 71, 73, 78, 79 Series	Ed-5–Ed-7
Parkrimp® 2 – 26, 46, 48, 70, 71, 73, 78, 79, S6 Series	Ed-8–Ed-11

Parker Hannifin assumes no liability for typographical errors or other errors

MiniKrimp®**Hose crimping machine for small sizes up to size -8****Main Features**

- Used for service with handpump
- Ideal for Hose Doctor van, service car, small workshops and service stations
- Ideal for outside work, easily portable
- Crimps one and two steel wire or textile braided rubber hoses from size -4 up to size -8

**Technical / Order Data**

Setup time:	20 sec
Dimensions:	L 127 mm x W 178 mm x H 394 mm
Weight:	16 kg

Machine

Part-No.: 94C-001-PFD

Die rings:

silver **Part-No.: 82C-R01-PFD**black **Part-No.: 82C-R02**

The black die ring is not included in the standard equipment.
Please order separate!

AccessoriesMiniCrimp sturdy, mobile **Part-No.: 025077-PFD**Operation stability **Part-No.: 015306**Mounting on a vice **Part-No.: 015307**Sophisticated folding stand **Part-No.: 94C-MKS2**

MiniCrimp sturdy, mobile



Operation stability



Mounting on a vice



Sophisticated folding stand

Primary Application Areas

The MiniKrimp gives you everything you need to crimp rubber hoses from size -4 up to size -8

Restrictions

Not suitable for multispiral hoses or two piece fittings.

Not suitable for regular crimping of size -12 and size -16 hoses.

Fittings Series

HPDE: 26, 43, 46, 48

PFDE: 55, 56, 58, 91N, EH

Information about standard products or non-standard products can be found in the current price list.
Dimensions shown may be changed at any time without prior notice.

KarryKrimp® 1 – Crimping Press 82CE-061

Portable crimper for braided hoses

Main Features

- Crimps one and two steel wire or textile braided hoses from size -4 up to size -20
- Easily portable for outside work
- Used for service with hand pump or airhydraulic and electrical pump



Technical / Order Data

KarryKrimp 1 with hand pump,
hose assembly and 2 die rings

Dimensions: H 686 mm x W 380 mm x D 305 mm

Weight: 23 kg

Part-No.: 82CE-061

KarryKrimp 1 with airhydraulic pump (82CE-0AP),
hose assembly and 2 die rings

Weight: 27 kg

Part-No.: 82CE-003

Machine Weight: 18 kg

Part-No.: 82C-061

(for crimper without pump)

Die rings:

silver **Part-No.: 82C-R01**

black **Part-No.: 82C-R02**

Hose assembly

Part-No.: 82C-00L

Primary Application Areas

Small workshops, repair shops,
mobile service vehicles

Restrictions

*Not suitable for multispiral hoses or two
piece fittings and do not use the machines
to assemble stainless steel fittings.*

Fittings Series

HPDE: 26, 43, 46, 48

PFDE: 55, 56, 58, 91N, EH

KarryKrimp® 2 – Crimping Press 85CE-061

Portable crimper for braided and multispiral hoses

Main Features

- Crimps one and two steel wire or textile braided hoses
- three steel wire braided hoses
- 4SP multispiral hoses
- 4SH multispiral hoses
- six steel wire multispiral hoses
- Easily portable for outside work
- Used for service with hand pump, airhydraulic or electrical pump

up to size -20
up to size -16
up to size -16
up to size -16
up to size -16



Technical / Order Data

Crimping machine complete with hose assembly, quick coupling, 2 die rings, take-apart stand.

Dimension

for machine: H 762 mm x B 356 mm x T 381 mm

Weight with handpump: 58 kg

Weight without handpump: 46 kg

Machine

Part-No.: 85CE-061

(for crimper with handpump)

Part-No.: 85C-061

(for crimper without handpump)

Part-No.: 85CE-003

(for crimper with turbo air pump)

Die rings:

silver **Part-No.: 85C-R01**

black **Part-No.: 85C-R02**

Primary Application Areas

Small workshops, repair shops, mobile service vehicles

Restrictions

Not suitable for multispiral hoses sizes -20, -24 and -32.

Not for two piece fittings.

Crimps both steel and stainless steel fittings.

Fittings Series

HPDE: 26, 43, 46, 48, 70, 71, 73, 78

PFDE: 55, 56, 58, 91N, EH

PHastkrimp® – Crimping Press 89CE-061

Fast benchmounted crimper for braided and multispiral hoses

Main Features

- Crimps one and two steel wire or textile braided hoses up to size -20
- three steel wire braided Compact hoses up to size -16
- 4SP steel wire multispiral hose up to size -16
- 4SH steel wire multispiral hose up to size -16
- six steel wire multispiral hose up to size -16
- SAE 100 R13 four steel wire multispiral hose up to size -16
- Used for service with 400 V hydraulic power unit



Technical / Order Data

Electrical power: 400 V / 16 A / 50 Hz
 Dimensions: H 1477 mm x W 866 mm x D 1298 mm
 Weight: 249 kg

PHastkrimp with two die rings

Part-No.: 89CE- 061

Die rings:

silver **Part-No.: 85C-R01**

black **Part-No.: 85C-R02**

Primary Application Areas

Small workshops and repair shops
 (for small series)

Restrictions

*Not suitable for multispiral hoses sizes -20, -24 and -32.
 Not for two piece fittings.
 Crimps both steel and stainless steel fittings.*

Fittings Series

HPDE: 26, 43, 46, 48, 70, 71, 73, 78
 PFDE: 55, 56, 58, 91N, EH

Parkrimp® 2 – Crimping Press 83CE

Benchmounted crimper for all the Parkrimp *No-Sliver* hose types from size -4 up to size -32, including 4 and 6 layer multispiral hoses

Main Features

- Crimps one and two steel wire or textile braided hoses up to size -32
- three steel wire braided Compact hoses up to size -32
- four steel wire multispiral hoses up to size -32
- six steel wire multispiral hoses up to size -32
- Used for service with 400 V hydraulic power unit



Technical / Order Data

Electrical power: 400 V / 3,0 KW / 50Hz
 Electrical connection: 16 A
 Dimensions: H 1130 mm x W 490 mm x D 820 mm
 Weight: Packed: 392 kg
 Unpacked: 342 kg

Parkrimp 2
 with power unit, but without die sets, bench mounted.
Part-No.: 83CE-083U

Power unit
Part-No.: 83CE-380U

Primary Application Areas

Workshops and repair shops
 (for small series)

Fittings Series

HPDE: 26, 43, 46, 48, 70, 71, 73, 78, 79, S6
 PFDE: 55, 56, 58, 91N, EH

Information about standard products or non-standard products can be found in the current price list.
 Dimensions shown may be changed at any time without prior notice.

Accessories for KarryKrimp® 1 and KarryKrimp® 2

For use with Karrykrimp 1 crimping press

Hand Pump 82C-2HP

Working pressure: max. 70 MPa
 Dimensions: L 530 mm x W 121 mm x H 178 mm
 Weight: 4,1 kg
 Hydraulic oil: HLP32 - 1,2 l
 Leverforce: 46 kg

Part-No.: 82C-2HP



Air-/Hydraulic Pump 82CE-0AP

Working pressure: max. 70 MPa at 0,4 to 0,7 MPa
 Connection: Hydr. 3/8-18NPTF thread
 Air 1/4-18NPTF thread
 Dimensions: L 395 mm x W 148 mm x H 145 mm

Part-No.: 82CE-0AP



For use with KarryKrimp 1 and KarryKrimp 2 crimping presses

Hand Pump 85CE-0HP

Working pressure: max. 70 MPa
 Dimensions: L 539 mm x W 417 mm x H 151 mm
 Weight: 11,6 kg
 Tank capacity: 2294 ccm
 Lever Force: 55 kg

Part-No.: 85CE-0HP



Power Pump 82CE-0EP

Working pressure: 70 MPa with 3/2 hand valve
 Dimensions: L 244 mm x W 244 mm x H 362 mm
 Weight: 12 kg
 Tank capacity: 2000 ccm
 Connection: Single phase / 230V / 50/60 Hz; 10A

Part No.: 82CE-0EP



Turbo Air Pump 85C-0AP

Working pressure: 70 MPa
 Dimensions: L 320 mm x W 200 mm x H 267 mm
 Weight: 8,4 kg
 Tank capacity: 662 ccm
 Compressed-air supply: 1/4-18NPTF thread

Part-No.: 85C-0AP



Hose Assembly 82C-00L

Hose assembly to connect either hand pump or airhydraulic pump to the press.

Length: 1830 mm
 Port size: 1. 3/8-18NPT male
 2. Coupling 3/8"
 Working pressure: max. 70,0 MPa

Part No.: 82C-00L



Information about standard products or non-standard products can be found in the current price list.
 Dimensions shown may be changed at any time without prior notice.

Parkrimp® – Die Sets

Parker's Colour-Coded Die Sets

- Chain linked segments keeps segments together
- No loose parts to mismatch or misplace
- The die crimp provides 360-degree gripping power for greater impulse life



Hose I.D. size	DN	Die sets	Part-No.									
			Series 26	Series 43	Series 46	Series 48	Series 70	Series 71	Series 73/78/79	Series S6	Series 76	
-4	6	red	80C-E04	80C-A04	80C-B04	80C-C04						
-5	8	violet	80C-E05	80C-A05	80C-B05	80C-C05						
-6	10	yellow	80C-E06	80C-A06	80C-B06	80C-C06	83C-D06	83C-D06				
-8	12	blue	80C-E08	80C-A08	80C-B08	80C-C08	83C-D08	83C-D08				
-10	16	orange	80C-E10	80C-A10	80C-B10	80C-C10	83C-D10	83C-D10				
-12	20	green	80C-E12	80C-A12	80C-B12	80C-C12	83C-D12	83C-D12	83C-L12 or 80C-L12			83C-U12
-16	25	black	80C-E16	80C-A16 or 83C-A16H*	80C-B16	80C-C16 or 83C-C16H*	83C-D16 or 83C-D16H	83C-D16 or 83C-D16H	83C-L16 or 80C-L16			83C-U16
-20	32	white	83C-E20	80C-A20 or 83C-A20H*	80C-B20	80C-C20 or 83C-C20H*	83C-D20 or 83C-D20H*	83C-D20 or 83C-D20H*	83C-L20			
-24	40	red	83C-E24	83C-A24*		83C-C24	83C-D24	83C-D24	83C-L24			
-32	50	green	83C-E32	83C-A32*		83C-C32		83C-D32	83C-L32	83C-L32		

Note: *Please consult the pages Ec for assembly instructions.

Die sets with the „H“ suffix are used for jump sizes and certain metric fittings to permit insertion and removal of fittings.

Die sets 80C-XX 8 segments are chained together. Die sets 83C-XX consist of two chained halves. Exceptions 83C-D06, -D08, -D10, -D12, -D16

Hose Cut-Off Machine EM 10.P

Main Features

- Cuts textile or one steel wire braided hoses up to size -16
two steel wire braided hoses up to size -12
- Can be used on a workbench or in a vice bench
- Blade protected by a safety cover during use
- Equipped with an electrical safety switch



Technical / Order Data

Electric-motor:	Circular saw motor 230 V 50/60 Hz, 900 W, 4400 rpm
Cutting disc:	160 x 2,5 x 20 mm (HSS)
Dimensions:	L 360 mm x W 340 mm x H 310 mm
Weight:	6,9 kg
Electric isolation:	According VDE KI.II 0740
Radioshielding:	According VDE 0875

Machine

Part-No.: EM 10.P

Cutting Blade, smooth

Part-No.: TM 160 x 2,5 x 20

Primary Application Areas

Repair shops or repair vehicles
Preferably in connection with
MiniKrimp and KarryKrimp 1

Restrictions

*Not suitable for multispiral hose.
Not suitable for large bore
industrial hoses.*

Hose Cut-Off Machine TH 3-2-12VDC

Main Features

- Cuts 1 and two steel wire or textile braided hoses up to size -20 (DN 32) four steel wire multispiral hoses up to size -16 (DN 25)
- For mobile service vehicles with 12 V connection

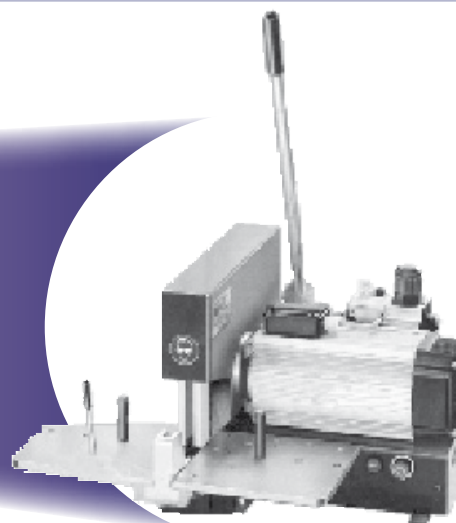

Technical / Order Data

Dimensions: W 650 mm x D 420 mm x H 300 mm
(with hand lever H = 1050 mm)

Weight: 50 kg

Standard smooth blade
Diameter: 275 mm x 3 mm x 30 mm

Machine

Part-No.: TH3-2-12VDC

Replacement blade

Part-No.: T891179

Primary Application Areas

Mobile service vehicles

Restrictions

*Not suitable for large bore hose
or multispiral hose*

Information about standard products or non-standard products can be found in the current price list.
Dimensions shown may be changed at any time without prior notice.

Hose Cut-Off Machine TH 3-2

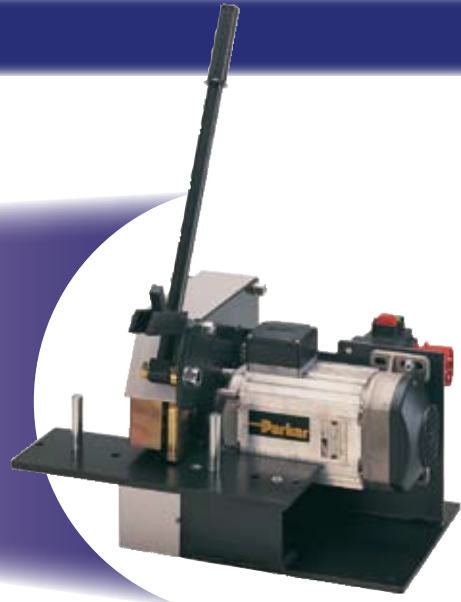

Main Features

- Cuts one and two steel wire or textile braided hoses up to size -32
- four steel wire multispiral hoses up to size -20
- Blade covered during use

Technical / Order Data

Electrical power: 400 V - 3,5 KW - 50 Hz - 16 A
 Exhaust system: 50 mm diameter
 Dimensions: W 540 mm x D 400 mm x H 300 mm
 (with hand lever H 750 mm)
 Weight: 45 kg

Machine with standard smooth blade
 Diameter: 275 mm x 3 mm x 30 mm

Machine
Part-No.: TH3-2

Replacement blade
Part No. T891179

Primary Application Areas

Service in hose workshops and for small series production

Restrictions

Not suitable for 4 or 6 layer multispiral hoses in size -24 and -32 (DN 40 and 50)

Hose Cut-Off Machine TH 3-3

Main Features

- Cuts one and two steel wire or textile braided hoses up to size -32
- four steel wire multispiral hoses up to size -32
- six steel wire multispiral hoses up to size -20
- Blade covered during use

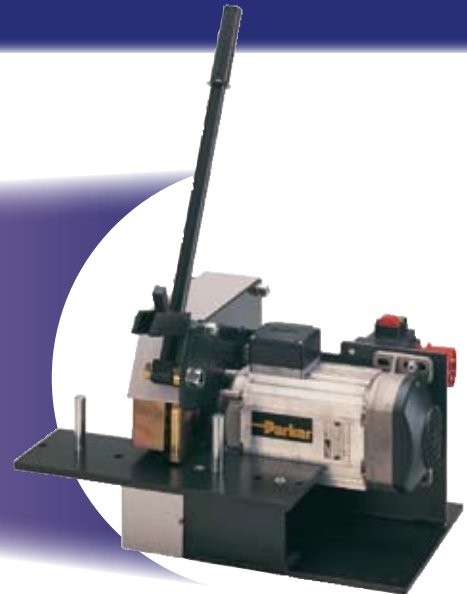

Technical / Order Data

Electrical power: 400 V - 3,7 KW - 50 Hz - 16 A
 Exhaust system: 50 mm diameter
 Dimensions: H 370 mm x W 650 mm x D 580 mm
 (with hand lever H 1050 mm)
 Weight: 75 kg

Machine with standard smooth blade
 Diameter: 350 mm x 3 mm x 30 mm

Machine
Part-No.: TH3-3

Replacement blade
Part-No.: T891180

Serrated blade
 Diameter: 350 mm x 3 mm x 30 mm
Part-No.: T905871

Primary Application Areas

Service in hose workshops and for small series production

Restrictions

Cutting 6 layer multispiral hoses will reduce the service life of the blade.

Hose Cut-Off Machine TH 3-13

Main Features

- 2 different motor alternatives: 12 Volt or 400 Volt
- 400 V machine cuts
 - one and two steel wire or textile braided hoses up to size -32
 - four steel wire multispiral hoses up to size -20
- 12 V machine cuts
 - one and two steel wire or textile braided hoses up to size -20
 - four steel wire multispiral hoses up to size -12
- Robust construction, highly reliable and easily to operate
- Smoke evacuation connection (prepared)

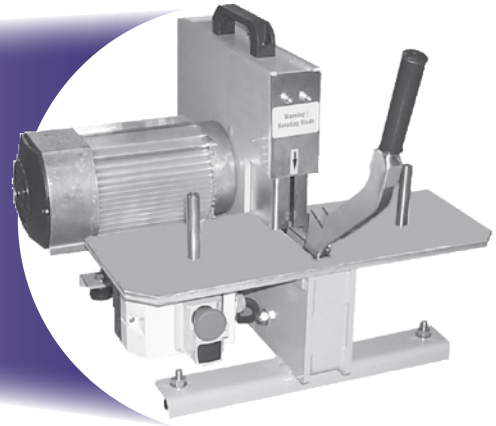

Technical / Order Data

Max. hose diameter:	80 mm
Motor 12V/3-phase:	1, 1/3, 0 kW
Voltage 3-phase:	400V/16A/50Hz
Voltage 12V:	12V
Velocity:	2880 rpm
Diameter (blade), ext.:	300 mm
Diameter (blade), int.:	50 mm
Connection to external smoke evacuation system:	63 mm
Colour:	Light grey
Dimensions:	L 450 mm x W 400 mm x H 430 mm
Weight:	45 kg

Machine 400 V 3-phase

Part-No.: TH3-13-3PH

Machine 12 V

Part-No.: TH3-13-12V

Cutting blade, smooth 300 mm x 3 mm x 50 mm

Part-No.: TH3-13-BS

Cutting blade, toothed 300 mm x 3 mm x 50 mm

Part-No.: TH3-13-BT

Primary Application Areas

Smaller workshops and service vans
Hose doctor vans

Restrictions

Multispiral hose with 4 or 6 spiral steel wires in big sizes (-20, -24 and -32). 12 Volt version, please note the care specification.

Hose Cut-Off Machine TH 3-14

Main Features

- Cuts one and two steel wire or textile braided hoses up to size -32
- four steel wire multispiral hoses up to size -32
- six steel wire multispiral hoses up to size -20
- Very safe operation
- "Open throat" hatch for inserting the hose from the front
- Pre-selection of three different cutting speeds to avoid overheating of the blade
- Variable cutting stroke

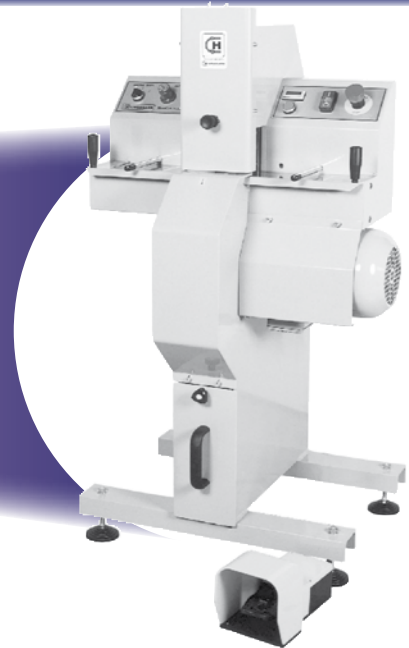

Technical / Order Data

Max. outside hose diameter:	80 mm
Motor:	5,5 kW
Voltage:	230/400V/16A/50Hz
Velocity:	2850 rpm
Diameter (blade), ext.:	400 mm
Diameter (blade), int.:	50 mm
Air pressure:	min. 6,0 bar
Counter:	0 - 9999 pcs
Hose connection for smoke evacuation system:	100 mm
Colour:	Light grey
Dimensions:	L 700 mm x D 600 mm x H 1300 mm

Machine 400 V 3-phase

Part-No.: TH3-14-3PH

Cutting blade, standard 400 mm x 4 mm x 50 mm

Part-No.: TH3-14-BS

Cutting blade, toothed "TS" 400 mm x 4 mm x 50 mm

Part-No.: TH3-14-BT

Delivery in the basic version with smoothed cutting blade.

Primary Application Areas

Service and series production hose workshops for multispiral hose and big dimension

Restrictions

Not recommended for constant cutting of large bore 4 or 6 wire multispiral hoses. Not for shorter than 300 mm hose length.

Hose Cut-Off Machine TH 3-15

Main Features

- Cuts all hose types up to 75 mm O.D.
- Cuts one, two and three steel wire or textile braided hoses
four and six steel wire multispiral hoses
- Extremely strong hydraulic and pneumatically operated hose cutting machine for heavy duty series production
- "Open throat" hatch for inserting the hose from the front
- Pneumatic hose pre-bending system (3 different cutting strokes)
- Motor controlled cutting blade brake
- Variable cutting speed control to avoid overheating of the blade
- Waste collected in a bin

up to size -40
up to size -32

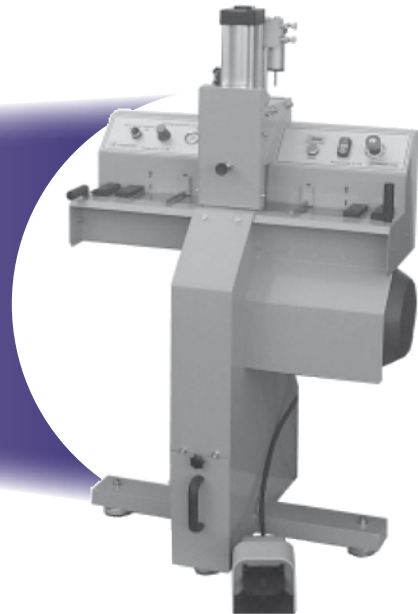

Technical / Order Data

Max. outside hose diameter:	75 mm
Motor:	7,5 kW
Voltage 3-phase:	230/400V/25A/50Hz
Velocity:	2850 rpm
Diameter (blade), ext.:	520 mm
Diameter (blade), int.:	50 mm
Counter:	0 - 9999 pcs
Connection to smoke evacuation system:	100 mm
Colour:	Light grey
Dimensions:	L 900 mm x D 645 mm x H 1150 mm
Weight:	210 kg

Machine, 400V 3-phase

Part-No.: TH3-15-3PH

Cutting blade, smooth 520 mm x 4 mm x 38 mm

Part-No.: TH3-15-BS

Cutting blade, toothed 520 mm x 4 mm x 38 mm

Part-No.: TH3-15-BTF

Cutting blade, toothed 520 mm x 4 mm x 50 mm

Part-No.: TH3-15-BTS

Adapter ring, 50 mm x 38 mm

Part-No.: TH3-15-BAR

Primary Application Areas

Service and series production in workshops for all typical hydraulic hoses up to size -32. Also suitable for cutting larger bore industrial hoses up to 75 mm O.D.

Restrictions

Not for shorter than 300 mm hose length.

Marking Machines TH4-7, TH4-8

Main Features

- Manual or pneumatically driven
- Suitable for marking all one and two piece fittings series up to size -32

Primary Application Areas

Smaller workshops and service vans

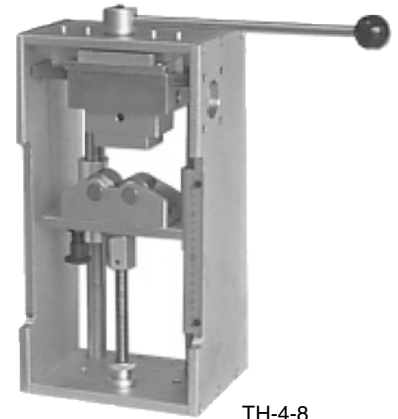

TH4-8

Technical / Order Data

Colour: Zinc plated

Machine manual TH 4-8

(excl. QC-adapter and type holders)

Dimensions: L 500 mm x W 200 mm x H 500 mm

Weight: 28 kg

Part-No.: TH4-8

Machine pneumatic TH 4-7

(excl. QC-adapter and type holders)

Air pressure: min. 0,6 MPa

Dimensions: L 500 mm x W 380 mm x H 500 mm

Weight: 35 kg

Part-No.: TH4-7

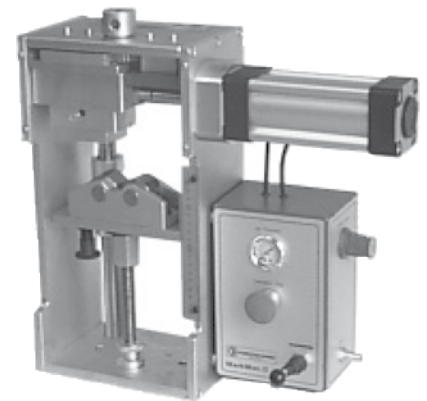

TH4-7

Type case 3 mm x 6 mm x 19 mm

Part-No.: TH4-9

Type print holder 2 lines

Part-No.: TH4-9-1

QC-adapter for type print holder

Part-No.: TH4-10

One type case consists of:

AAABBCDDEEEFFGGHHIIJJKK
 LLLMMNNNOOPPQQRRRSSSTT
 UUUUVVWXYZ//...,11112222333344
 44556667778889990000 and 20 pcs of blanks
 + mirror

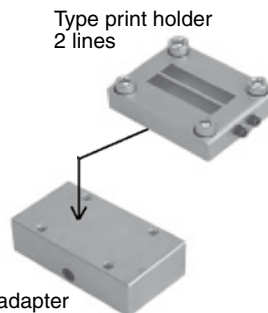

QC-adapter



Type box

Information about standard products or non-standard products can be found in the current price list.
 Dimensions shown may be changed at any time without prior notice.

Hand Marking Tool TH4-4 U

Main Features

- Hand marking tool for marking the crimp shells of one piece or two piece hose fittings.
- This machine is designed for hose fittings up to 2" (DN 50).
- Permanent and easy marking in hose assembling workshops
- The type print holder with two line make it possible to print additional information on the shell or fittings
- An adjustable stamping head with 11 letter wheels can be fitted as an optional extra



Technical / Order Data

Marking area:	Diameter AD 11,5 mm – 100 mm
Marking depth:	0,5 mm
Letter size:	4 mm
Stamping depth:	3 mm
Dimensions:	L 250 mm x W 340 mm x H 450 mm
Weight:	13 kg
Type print holder:	2 lines

Marking tool inclusive

Part-No.: TH4-4U

Marking types box with steel types numbers, letters mirror and tweezers.

Part-No.: UPTS 100

Type print holder 2 lines

Part-No.: UPTH-22b

Optional

Quick change stamping tool, single line

Part-No.: UPTH-PW 11

Primary Application Areas

Hose service stations

Parker Store und Hose Doctor service vans

Hose workshops for maintenance at OEM customers.



Stamping tool UPTH-PW 11,
Not included

Cleaning Machine TH6-6

Main Features

- Cleaning device for hose and hose assemblies for hoses up to size -20
- Ensures a degree of cleanliness up to oil purity class 17/14 according ISO 4406
- Air connection min. 0,7 MPa required

Technical / Order Data

Dimensions: W 435 mm x D 960 mm x H 940 mm

Weight: 55 kg

Weight with cleaning fluid: 93 kg

Machine

Part-No.: TH6-6

Neutral cleaning fluid additive (18 litre drum)

Part-No.: H899771

Filter set (without cartridges)

Part-No.: H899959

Filter cartridges 3 µm

Part-No.: 600.4



Cleaning System TH6-7

Main Features

- A quick and simple system using compressed air to clean hoses
- Delivered with two plastic nozzles for hoses from size -4 up to -32. The hose is pressed against the nozzle and thereby opens a valve to allow the compressed air to blow through the hose and blow out loose particles.

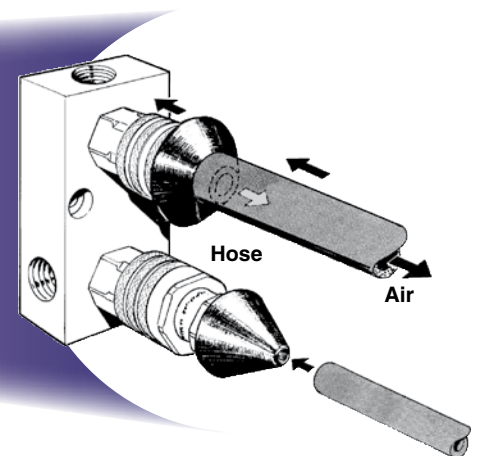

Technical / Order Data

Air pressure: min. 0,6 MPa

Air connection: 1/2" BSP

Dimensions: L 120 mm x W 50 mm x H 100 mm

Weight: 0,3 kg

System complete

Spare, nozzle 30mm

Spare, nozzle 55mm

Part-No.: TH6-7

Part-No.: TH6-7-30

Part-No.: TH6-7-55

Information about standard products or non-standard products can be found in the current price list. Dimensions shown may be changed at any time without prior notice.

Parker „Hoze-Oil“

Parker's hose assembly lubricant is pressure and temperature resistant. Simply dip the hose ends into Parker hoze-oil and slightly lubricate the tooling prior to crimping.

1-litre bottle

Part-No.: Hoze-Oil



Assembly Tool

Tool designed for assembly of Push-Lok® fittings and hose in all sizes. Toggle actions greatly reduce effort necessary to hold hose and press in fitting. Only a few pounds of force is needed on either handle to quickly assemble any size.

Overall length: 320 mm

Weight: 2,2 kg

Part-No.: 611050G

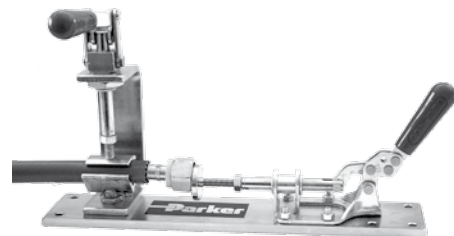

Push-Lok® Assembly Oil H896137

Water-oil emulsion for easier assembly of Parker Push-Lok® fittings.

This product is very useful in combination with 830M, 837BM and 837PU hoses as the Push-Lok® assembly oil is free from wetting disturbing substances, e.g. silicone (Labs-free).

1-litre bottle

Part-No.: H896137



OilOn TH11-3

Oiling pad for lubrication of fittings

The perfect way to lubricate the fitting, making it easier to insert into the hose. A foam rubber sponge that evenly disperses the oil onto the fitting, in an effective and easy manner.

Material steel/plastic: L 130 mm x W 130 mm x H 70 mm

OilOn

Part-No.: TH11-3

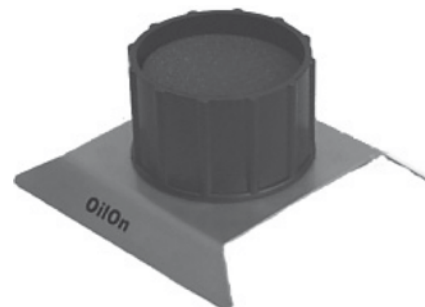

Information about standard products or non-standard products can be found in the current price list. Dimensions shown may be changed at any time without prior notice.

Hose Assembly Test Bench TH5-3

Pressure test bench up to 145,0 MPa (1450 bar)

Main Features

- Totally sealed test chamber
- Safety interlock – pressure automatically decreases within 1/10 sec. when the test chamber is opened
- Rapid fill and automatic air bleeding of the test piece
- Weight compensated protection cover with safety windows
- Bio-degradable water-oil emulsion as test medium
- Simple operation



Technical / Order Data

Test pressure:	12,0 - 145,0 MPa
Drive:	Intensifier
Rating:	Compressed air 7 bar, 800 l/min.
Pressure regulator:	Automatic
Test medium:	Water-oil emulsion
Safety control unit:	Yes
Tank capacity:	100 litres
Dimensions:	L 2030 mm x W 840 mm x H 1260 mm
Weight:	96 kg (empty)
Weight with medium:	196 kg
Colour:	Black/ silver
Accessories:	Operating instructions, filter 100 µm, air service unit

Subject to technical changes

Test bench

Part-No.: TH5-3

Test bench with result recording unit:

Part-No.: TH5-3E

HD adapter set

Part-No.: 405.906

10 l corrosion protection

Part-No.: H899770

Adapters for other nominal sizes on request

Primary Application Areas

- Service and series production in workshops
- The Hose assembly test bench makes the efficient and safe final inspection of hose assemblies practical and fast.
- Static pressure testing of other hydraulic components is also possible.
- Continuous result recording can be made using the TH5-3E

Restrictions

The test bench is not designed for burst pressure testing.

Due to the limited flexibility of large bore multispiral hoses the test bench is not ideal for size -24 and size -32 pressure testing.

Information about standard products or non-standard products can be found in the current price list. Dimensions shown may be changed at any time without prior notice.

Hose Reel TH7-12

Main Features

- Seven stage reel for hoses size -4 to -20
- Every stage (except bottom stage) can be swung out horizontally so that new roll can easily be inserted

Technical / Order Data

Max. load per reel:	80 kg
Colour:	Zinc plated
Dimensions: L 1270 mm x W 1000 mm x H 2230 mm	
Weight:	148 kg

Dimensions Reel:

Internal max. diameter reel (coil):	1010 mm
Internal min. diameter reel (coil):	250 mm
Height of the hose coil max.:	300 mm

Hose reel

Part-No.: TH7-12



Primary Application Areas

Service and series production in workshops

Hose Reel TH7-13

Main Features

- One-stage reel for hoses size -4 to -32
- Table adjustable to fit the center of the coil

Technical / Order Data

Max. load of reel:	500 kg
Colour:	Zinc plated / grey
Dimensions: L 1200 x W 1200 mm x H 830 mm	
Weight:	40 kg

Dimensions Reel:

Internal diameter, adjustable:	150 - 500 mm
--------------------------------	--------------

Hose reel

Part-No.: TH7-13



Primary Application Areas

Service and series production in workshops

Information about standard products or non-standard products can be found in the current price list.
Dimensions shown may be changed at any time without prior notice.

Hose Reel TH7-14

Horizontal motorized reel

Main Features

- Motorized reel for hoses size -4 to -32
- Variable speed control in both directions
- Ideal for cutting long lengths where winding is necessary

Technical / Order Data

Voltage single phase:	230V/10A/50Hz
Max. load of reel:	500 kg
Colour:	Zinc plated / light grey
Dimensions:	W 1200 mm x H 830 mm
Weight:	65 kg

Dimensions Reel:	
Internal diameter, adjustable:	150 - 500 mm

HoseReel
Part-No.: TH7-14

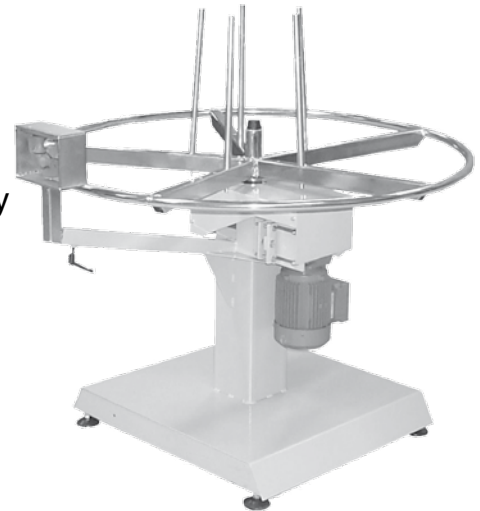

Primary Application Areas

Service and series production in workshops

Hose Reel TH7-15

Vertical motorized reel

Main Features

- Motorized reel for hoses size -4 to -20
- Variable speed control in both directions
- Ideal for cutting long lengths where winding is necessary
- Very easy to unload

Technical / Order Data

Voltage single phase:	230V/10A/50Hz
Max. load of reel:	100 kg
Colour:	Zinc plated
Dimensions:	W 600 mm x H 1400 mm
Weight:	75 kg

Dimensions Reel:	
Internal diameter, adjustable:	250 - 800 mm

HoseReel
Part-No.: TH7-15

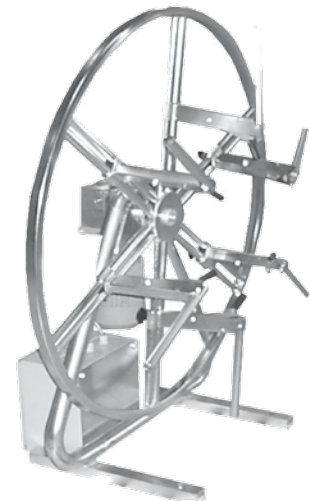

Primary Application Areas

Service and series production in workshops

Information about standard products or non-standard products can be found in the current price list.
Dimensions shown may be changed at any time without prior notice.

Flange Half

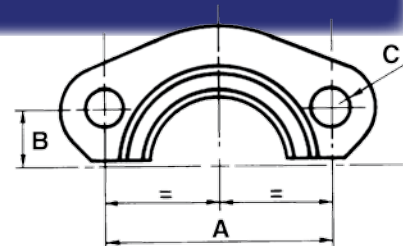

FHS3 / M1H / 51H
SAE code 61 Flange Half – Standard Series
 ISO 6162

XXXX-XX-XX Part Number		Flange			A	B	C	 max. dynamic working pressure MPa (psi)
actual part number	old	DN	Inch	Size	mm	mm	mm	
FHS32A3CX	M1H-8	13	1/2	-8	38,1	8,7	8,5	34,5 (5000)
FHS33A3CX	M1H-12	19	3/4	-12	47,6	11,1	10,5	34,5 (5000)
FHS34A3CX	M1H-16	25	1	-16	52,4	13,1	10,5	34,5 (5000)
51H-20	51H-20	32	1-1/4	-20	58,7	15,1	12,5	27,5 (4000)
51H-24	51H-24	38	1-1/2	-24	69,9	17,9	13,5	21,0 (3000)
51H-32	51H-32	51	2	-32	77,7	21,4	14,5	21,0 (3000)

50H – 5000 psi code 61 Flange Half
 ISO 6162

XXXX-XX-XX Part Number		Flange			A	B	C	 max. dynamic working pressure MPa (psi)
		DN	Inch	Size	Inch	Inch	Inch	
50H-20		32	1-1/4	-20	2,31	0,59	0,47	34,5 (5000)
50H-24		40	1-1/2	-24	2,75	0,70	0,53	34,5 (5000)
50H-32		50	2	-32	3,06	0,84	0,53	34,5 (5000)

For use with 4A, 4F and 4N flanges.

FHS6 / M2H – SAE code 62 Flange Half – Heavy Series
 ISO 6162

XXXX-XX-XX Part Number		Flange			A	B	C	 max. dynamic working pressure MPa (psi)
actual part number	old	DN	Inch	Size	mm	mm	mm	
FHS62A3CX	M2H-8	13	1/2	-8	40,5	9,1	8,7	41,0 (6000)
FHS63A3CX	M2H-12	19	3/4	-12	50,8	11,9	10,5	41,0 (6000)
FHS64A3CX	M2H-16	25	1	-16	57,2	13,9	12,5	41,0 (6000)
FHS65A3CX	M2H-20	32	1-1/4	-20	66,6	15,9	14,7	41,0 (6000)
FHS66A3CX	M2H-24	38	1-1/2	-24	79,2	18,2	16,6	41,0 (6000)
FHS68A3CX	M2H-32	51	2	-32	96,8	22,2	19,9	41,0 (6000)

On request we can deliver:

- full flanges code 61 and 62
- flange kits
- flanges for inch bolts

Information about standard products or non-standard products can be found in the current price list. Dimensions shown may be changed at any time without prior notice.





O-Rings

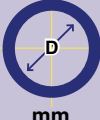

Fittings are supplied with O-rings made from ozone resistant Nitrile (NBR) rubber compound suitable for temperatures from -30 °C up to +105 °C

On request: Viton® (FPM) compound from -25 °C up to +200 °C
Ethylene-Propylene (EPDM) compound from -55 °C up to +150 °C

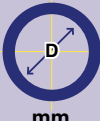

711509 – O-rings for SAE fittings (05 end configuration)

XXXX-XX-XX Part Number	 mm	 mm	Thread	
			UNF	Size
711509-1	8,92	1,83	7/16x20	-4
711509-2	10,52	1,83	1/2x20	-5
711509-3	11,89	1,98	9/16x18	-6
711509-4	16,36	2,21	3/4x16	-8
711509-5	19,18	2,45	7/8x14	-10
711509-6	23,47	2,95	1-1/16x12	-12
711509-7	29,74	2,95	1-5/16x12	-16
711509-8	37,47	3,00	1-5/8x12	-20

2-0 – O-rings for ORFS male (JD and JM end configuration)

XXXX-XX-XX Part Number	 mm	 mm	Thread	
			UNF	Size
2-011N552-90	7,65	1,78	9/16x18	-4
2-012N552-90	9,25	1,78	11/16x16	-6
2-014N552-90	12,42	1,78	13/16x16	-8
2-016N552-90	15,60	1,78	1x14	-10
2-018N552-90	18,77	1,78	1-3/16x12	-12
2-021N552-90	23,52	1,78	1-7/16x12	-16
2-025N552-90	29,87	1,78	1-11/16x12	-20
2-029N552-90	37,82	1,78	2x12	-24

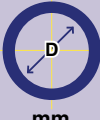

EARG/VURG/VERG – O-rings for BSP fittings

XXXX-XX-XX Part Number	 mm	 mm	Thread	
			Inch	Size
EARG-4	6,0	1,0	1/4x19	-4
C9RG-10	8,5	1,5	3/8x19	-6
VURG-4	12,0	1,5	1/2x14	-8
EARG-10	13,1	1,6	5/8x14	-10
VERG-14	17,0	1,5	3/4x14	-12
VERG-19	21,0	1,5	1x11	-16
EARG-20	29,5	1,5	1-1/4x11	-20

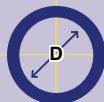

Information about standard products or non-standard products can be found in the current price list. Dimensions shown may be changed at any time without prior notice.

O-Rings



2-2 – O-rings for SAE flanges

XXXX-XX-XX Part Number	 mm	 mm	Flange	
			Inch	Size
2-210N552-90	18,64	3,53	1/2	-8
2-214N552-90	24,99	3,53	3/4	-12
2-219N552-90	32,92	3,53	1	-16
2-222N552-90	37,69	3,53	1-1/4	-20
2-225N552-90	47,22	3,53	1-1/2	-24
2-228N552-90	56,74	3,53	2	-32

CARG – O-rings for metric 24° female swivel hose-end fittings

XXXX-XX-XX Part Number	 mm	 mm			Tube O.D. mm
			light series metric	heavy series metric	
CARG-6	4,5	1,5	M12x1,5	M14x1,5	6
C9RG-8	6,5	1,5	M14x1,5	M16x1,5	8
C9RG-10	8,5	1,5	M16x1,5	M18x1,5	10
C9RG-12	10,5	1,5	M18x1,5	M20x1,5	12
C9RG-14	12,0	2,0		M22x1,5	14
CARG-15	12,5	2,0	M22x1,5		15
C9RG-16	14,0	2,0		M24x1,5	16
CARG-18	16,0	2,0	M26x1,5		18
C9RG-20	17,0	2,5		M30x2	20
CARG-22	20,0	2,0	M30x2		22
C9RG-25	22,0	2,5		M36x2	25
CARG-28	26,0	2,0	M36x2		28
C9RG-30	27,0	2,5		M42x2	30
CARG-35	32,0	2,5	M45x2		35
C9RG-38	35,0	2,5		M52x2	38
CARG-42	39,0	2,5	M52x2		42

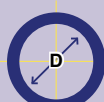
XARG – Flange “D” rings Caterpillar® style flanges

XXXX-XX-XX Part Number	 mm	 mm	Flange	
			Inch	Size
XARG-12	25,4	5,0	3/4	-12
XARG-16	31,9	5,0	1	-16
XARG-20	38,2	5,0	1-1/4	-20
XARG-24	44,7	5,0	1-1/2	-24

Choice of O-ring materials with their respective temperature ranges can be found on page Eb-2.

Information about standard products or non-standard products can be found in the current price list.
Dimensions shown may be changed at any time without prior notice.

Worm Drive Hose Clamps

With slotted hex head screw for all applications

Main Features



- Bands and housings of AISI 300 series stainless steel
- Unique interlock construction locks directly into band which tightens under tension
- Shouldered hex head, slotted screw
No spot welds to rupture under stress or corrode
- Rounded band edges
- High efficiency giving high pressure sealing
- Wide clamping range, giving more flexibility to the user



Miniature Worm Drive Hose Clamps

These small tough precision engineered hose clamps give:

- Low profile
- Narrow housing
- No protrusions
- Highest sealing
- High working pressure at low torque
- Easy to install in confined areas



Band width 5/16" - 8 mm

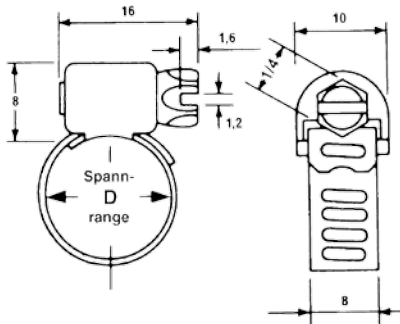

Series	D stretch area		Series
	mm	Inch	
M 0200	6 - 16	0,25 - 0,62	MS 0200 N
M 0300	8 - 22	0,30 - 0,87	MS 0300 N
M 0400	16 - 32	0,66 - 1,25	MS 0400 N
M 0500	16 - 38	0,66 - 1,50	MS 0500 N
M 0600	19 - 45	0,66 - 1,75	MS 0600 N
M 0700	25 - 50	1,00 - 2,00	MS 0700 N
M 0800	35 - 60	1,38 - 2,38	MS 0800 N
M 0900	45 - 70	1,75 - 2,75	MS 0900 N
M 1000	58 - 82	2,25 - 3,25	MS 1000 N
M 1100	64 - 90	2,50 - 3,50	MS 1100 N
M 1200	77 - 100	3,00 - 4,00	MS 1200 N

Miniature Stainless "M" Series

For all clamping applications meeting normal environmental conditions.
Hex head screw made of zinc plated carbon steel.

Miniature Stainless "MS-N" Series

Preferred for those environmental conditions which require the extra protection provided by this 100% stainless steel hose clamp. Hex head screw of AISI 305 series stainless steel.

For your safety

Hose clamps are intended to ensure the sealing of flexible hoses carrying fluids under pressure; we therefore recommend that you choose the appropriate hose clamp, adhere to the assembly torques indicated and correctly position the hose clamp onto the fitting. Any deformation of the hose requires tightening of the clamp. We disclaim all responsibility for any product failure that might ensue should these recommendations be ignored.

Information about standard products or non-standard products can be found in the current price list.
Dimensions shown may be changed at any time without prior notice.

Worm Drive Hose Clamps

With slotted hex head screw for all applications

Standard "S" Series

Band and housing of stainless steel for all clamping applications, meeting normal environmental conditions. Hex head screw made of zinc plated carbon steel.



Band width 9/16" - 14 mm

Series	D stretch area		Series
	mm	Inch	
S 0600	10 - 22	0,38 - 0,87	SS 0600 N
S 0800	11 - 25	0,44 - 1,00	SS 0800 N
S 1000	13 - 28	0,50 - 1,12	SS 1000 N
S 1040	129 - 178	5,00 - 7,00	SS 1040 N
S 1200	13 - 32	0,50 - 1,25	SS 1200 N
S 1600	19 - 40	0,75 - 1,50	SS 1600 N
S 2000	19 - 44	0,75 - 1,75	SS 2000 N
S 2400	26 - 50	1,00 - 2,00	SS 2400 N
S 2800	34 - 57	1,32 - 2,25	SS 2800 N
S 3200	40 - 64	1,57 - 2,50	SS 3200 N
S 3600	23 - 70	0,88 - 2,75	SS 3600 N
S 4000	29 - 76	1,13 - 3,00	SS 4000 N
S 4400	34 - 82	1,32 - 3,25	SS 4400 N
S 4800	42 - 90	1,63 - 3,50	SS 4800 N
S 5200	48 - 95	1,88 - 3,75	SS 5200 N
S 5600	54 - 100	2,13 - 4,00	SS 5600 N
S 6400	67 - 114	2,63 - 4,50	SS 6400 N
S 7200	80 - 130	3,13 - 5,00	SS 7200 N
S 8000	92 - 140	3,63 - 5,50	SS 8000 N
S 8800	108 - 150	4,25 - 6,00	SS 8800 N
S 9600	121 - 165	4,75 - 6,50	SS 9600 N

Stainless "SS-N" Series

Preferred for those environmental conditions which require the extra protection provided by this 100% stainless steel hose clamp. Hex head screw of AISI 305 series stainless steel.

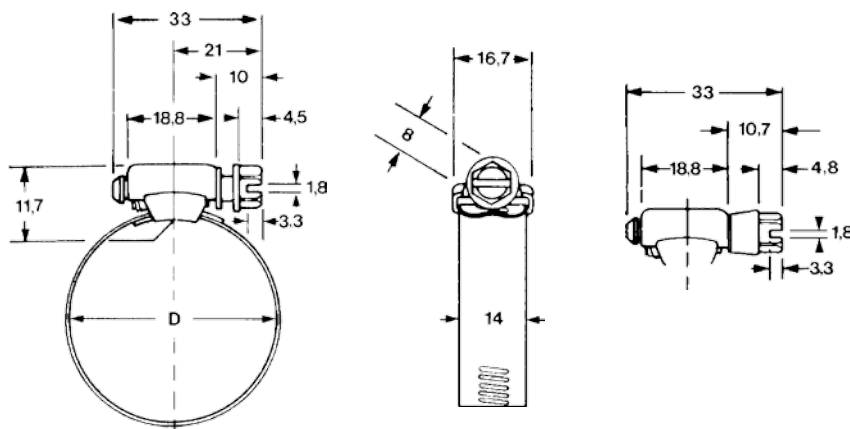

Numerous applications in all fields:



Automobile industry, ship building, automation systems, agricultural machinery, packaging machines, machine tools, mechanical handling equipment, welding equipment, construction equipment, petrochemical industry, mining, metallurgy.

Information about standard products or non-standard products can be found in the current price list. Dimensions shown may be changed at any time without prior notice.

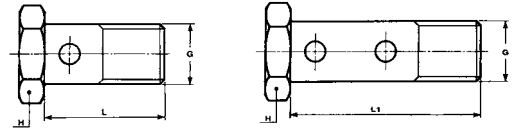
Banjo Bolt



AM/AR – Banjo Bolt (DIN 7643)

XXXX-XX-XX Part Number single	XXXX-XX-XX Part Number double	I.D. Banjo mm	 G Thread metric / Inch	L Single mm	L1 Double mm	 H mm
AM3	A2M3	8	M8x1	17	26	12
AM4	A2M4	10	M10x1	19	30	14
AR4		10	1/8	19		14
AM6	A2M6	12	M12x1,5	26	38	17
AM8	A2M8	14	M14x1,5	26	41	19
AR8		14	1/4	26		19
AR-08C		14	1/4	26		19
AM10	A2M10	16	M16x1,5	28	46	22
AR10		17	3/8	29		22
AM13		18	M18x1,5	32		24
AM16		22	M22x1,5	40		27
AR16		22	1/2	40		27
AM20		26	M26x1,5	45		32

Material: steel chromium(VI) free plated

853009 – Copper Ring (Form A DIN 7603)

XXXX-XX-XX Part Number	I.D. Banjo mm	 G Thread metric / Inch
853009-8	8	M8x1
853009-10	10	M10x1
853009-10	10	1/8
853009-12	12	M12x1,5
853009-14	14	M14x1,5
853009-14	14	1/4
853009-16	16	M16x1,5
853009-17	17	3/8
853009-18	18	M18x1,5
853009-22	22	M22x1,5
853009-21	22	1/2
853009-26	26	M26x1,5

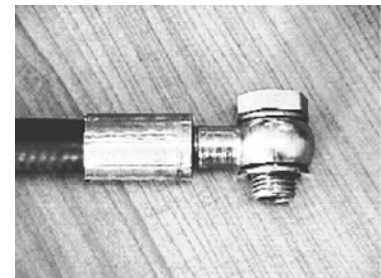

Complete banjo fitting

Banjo fitting, bolt, double bolt, copper ring

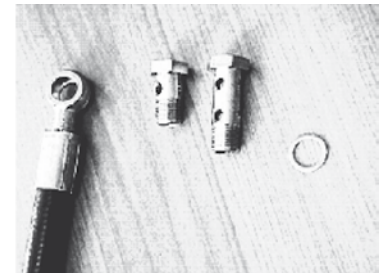

Information about standard products or non-standard products can be found in the current price list. Dimensions shown may be changed at any time without prior notice.

SG – Spring Guard

Main Features

The steel protective coil spring made from corrosion resistant wire protects the hose cover against abrasion.

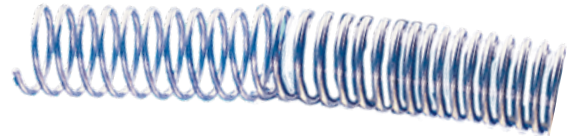

XXXX-XX-XX Part Number	I.D. mm	201 206 221FR 225 235	213 285 293	301SN 302 304	402 421RH 421SN 422 424 426 436 441 441RH 451TC 461LT 462 463 471TC 472TC 492 493 681DB 692	372 372RH 371LT	601	774 721TC	731 781 P35 791TC 792TC	801 804 821FR 831 836 837BM	811 881
SG-060	15,20	-4	-4/-5		-4		-4			-4/-5	
SG-066	16,75	-5	-6	-4	-5						
SG-072	18,25	-6		-5	-6		-5			-6	
SG-084	21,30	-8	-8	-6	-8		-6	-6		-8	
SG-097	24,60	-10	-10	-8	-10	-6	-8	-8		-10	
SG-106	26,90		-12	-10		-8					
SG-113	28,70	-12			-12			-10		-12	
SG-122	30,95			-12		-10					
SG-131	33,25	-16	-16			-12	-12	-12	-12	-16	-12
SG-155	39,35	-20	-20	-16	-16	-16	-16	-16			-16
SG-161	40,85										
SG-166	42,15								-16		
SG-182	46,20	-24	-24		-20		-20				-20
SG-209	53,05			-20	-24	-20		-20	-20		
SG-220	55,85		-32			-24		-24			-24
SG-232	58,90	-32		-24					-24		
SG-270	68,55				-32			-32			-32
SG-292	74,20	-40	-40	-32					-32		
SG-369	93,70	-48	-48								-48

Delivered in 3 meter lengths

Information about standard products or non-standard products can be found in the current price list. Dimensions shown may be changed at any time without prior notice.

AG – Armour Guard



Main Features

For extreme abrasion or possible damage from the outside, the corrosion protected steel flat coil sleeve is recommended.

Part Number	I.D. mm	201 206 221FR 225 235	213 285 293	301SN 302 304	402 421RH 421SN 422 424 426 436 441 441RH 451TC 461LT 462 463 471TC 472TC 492 493 681DB 692	372 372RH 371LT	601	774 721TC	731 781 P35 791TC 792TC	801 804 821FR 831 836 837BM	811 881
AG-060	15,20	-4	-4/-5		-4		-4			-4/-5	
AG-066	16,75	-5	-6	-4	-5						
AG-072	18,25	-6		-5	-6		-5			-6	
AG-084	21,30	-8	-8	-6	-8		-6	-6		-8	
AG-097	24,60	-10	-10	-8	-10	-6	-8	-8		-10	
AG-106	26,90		-12	-10		-8					
AG-113	28,70	-12			-12			-10		-12	
AG-122	30,95			-12		-10					
AG-131	33,25	-16	-16			-12	-12	-12	-12	-16	-12
AG-155	39,35	-20	-20	-16	-16	-16	-16	-16			-16
AG-161	40,85										
AG-166	42,15								-16		
AG-182	46,20	-24	-24		-20		-20				-20
AG-209	53,05			-20	-24	-20		-20	-20		
AG-220	55,85		-32			-24		-24			-24
AG-232	58,90	-32		-24					-24		
AG-270	68,55				-32			-32			-32
AG-292	74,20	-40	-40	-32					-32		
AG-319	81,00										-40

Delivered in 3 meter lengths

Information about standard products or non-standard products can be found in the current price list. Dimensions shown may be changed at any time without prior notice.

AS/PS – Partek® Nylon Protective Sleeve

Temperature Range -55 °C up to +120 °C



Part Number AS-heavy series (black)	Part Number AS-heavy series (yellow)	Part Number PS- standard series (black)	201 206 221FR 225 235	213 285 293	301SN 302 304 421WC	402 421RH 421SN 422 424 426 436 441 441RH 451TC 461LT 462 462ST 463 471TC 472TC 492 492ST 493 681DB 692	601	372 372RH 701 371LT	774 721TC	731 774 781 P35 791TC 792TC	811 881	801 804 821FR 831 836 837BM
AS-B-11	AS-Y-11	-	-4	-4		-4						-4
AS-B-13	AS-Y-13	PS-B-13	-5	-5	-4	-5	-4					
AS-B-13	AS-Y-13	PS-B-13	-6	-6	-5	-6	-5					-6
AS-B-15	AS-Y-15	PS-B-15	-8	-8	-6		-6					-8
AS-B-15	AS-Y-15	PS-B-15		-10		-8		-6	-6			
AS-B-17	AS-Y-17	PS-B-17	-10	-12	-8	-10	-8	-8	-8			-10
AS-B-19	AS-Y-19	-	-12		-12	-12	-12	-10	-10			-12
-	-	PS-B-22	-12		-12	-12	-12	-10	-10			-12
AS-B-22	AS-Y-22	PS-B-22	-16	-16				-12	-12	-12	-12	
AS-B-27	AS-Y-27	-				-16						-16
-	-	PS-B-33				-16						-16
AS-B-33	AS-Y-33	PS-B-33	-20	-20	-16		-16	-16	-16	-16	-16	
-	AS-Y-35	PS-B-35	-24	-24		-20					-20	
AS-B-37	AS-Y-37	PS-B-37			-20	-24	-20	-20	-20	-20		
-	-	PS-B-39	-32	-32	-24		-24	-24	-24	-24	-24	
-	-	PS-B-45			-32	-32	-32				-32	
-	-	PS-B-47	-40	-40				-32	-32	-32		
AS-B-58	-	-	-48	-48							-40/-48	

Information about standard products or non-standard products can be found in the current price list.
Dimensions shown may be changed at any time without prior notice.

FS-F – Fire Sleeves

Main Features

The firesleeve is constructed of a uniform single braid of glass fibre with a special outside coating. When fitting the firesleeve to hose assemblies with reusable or crimped fittings, a firesleeve clamp must be used.

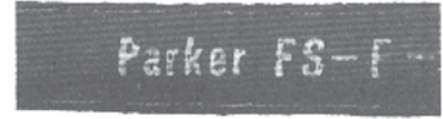

Temperature Range -73 °C up to +260 °C

Part Number	201 206 221FR 225 235	213 285 293	301SN 302 304 421WC	402 421RH 421SN 422 424 426 436 441 441RH 451TC 461LT 462 462ST 463 471TC 472TC 492 492ST 493 681DB 692	601	372 372RH 371LT 701 774 721TC	731 781 P35 791TC 792TC	801 804 821FR 831 836 837BM	811 881
FS-F-10	-4	-4		-3/-4				-4	
FS-F-11	-5	-5	-4	-5	-4				
FS-F-12		-6	-5					-6	
FS-F-14	-6/-8	-8	-6	-6	-5/-6			-8	
FS-F-16		-10		-8		-6			
FS-F-18	-10	-12	-8/-10	-10	-8	-8		-10	
FS-F-20	-12		-12	-12	-10	-10	-8	-12	
FS-F-22	-16	-16		-14	-12	-12	-12	-16	-12
FS-F-24				-16					
FS-F-28	-20	-20	-16		-16	-16	-16		-16
FS-F-32	-24	-24		-20	-20				-20
FS-F-38	-32	-32	-20/-24	-24		-20/-24	-20		-24
FS-F-40							-24		
FS-F-48	-40	-40	-32	-32		-32	-32		-32
FS-F-60	-48								-40/-48

Information about standard products or non-standard products can be found in the current price list. Dimensions shown may be changed at any time without prior notice.

HG / PG = PolyGuard-Hose Protector and ParKoil-Hose Protector

Main Features

- Shields hose from abrasion and cuts
- Easy to install
- Minimises risk of kinking
- Resistant to air, water, oil, gasoline hydraulic fluid and most solvents
- Ideal for bundling plastic tubing or hose lines



PolyGuard

heavy duty polyethylene provides protection in rugged operating conditions

Part Number	I.D. mm	201 206 213 221FR 225 235 285 293	301SN 302 304	402 421RH 421SN 421WC 422 424 426 436 441 441RH 451TC 461LT 462ST 462 463 471TC 472TC 492 492ST 493 681DB 692	601	372 372RH 371LT 701 731 774 721TC 781 P35 791TC 792TC	731	801 804 821FR 831 836 837BM	811 881
HG-075	19,05	-8/-10	-6/-8	-8/-10	-6/-8	-6		-8/-10	
HG-100	25,40	-12	-10/-12	-12	-10	-8/-10		-12	-12
HG-125	31,75	-16		-16	-12	-12	-12	-16	
HG-150	38,10	-20/-24	-16/-20	-20	-16/-20	-16	-16/-20		-16/-20
HG-200	50,80	-32/-40	-24/-32	-24/-32		-20/-24/-32	-24/-32		-24/-32/-40
HG-350	88,90	-48							-48

ParKoil

low-cost abrasion and kinking protection





Part Number	I.D. mm	201 206 221FR 225 235	213 285 293	301SN 302 304	402 421RH 421SN 421WC 422 424 426 436 441 441RH 451TC 461LT 462ST 462 463 471TC 472TC 492 492ST 493 681DB 692	601	372 372RH 371LT 701 731 774 721TC	781 P35 791TC 792TC	801 804 821FR 831 836 837BM	811 881	Width of spires
PG-038	9,65		-4								6,35
PG-050	12,70	-4/-5	-5	-3/-4	-4/-5	-4			-4/-5		9,65
PG-062	15,70	-6	-6/-8	-5	-6				-6		9,65
PG-075	19,05	-8	-10	-6	-8	-6	-6	-4	-8		9,65
PG-088	22,35	-10	-12	-8	-10	-8	-8	-6	-10		9,65
PG-100	25,40	-12		-10/-12	-12	-10	-10	-8/-10	-12		15,75
PG-119	30,20	-16	-16			-12	-12	-12	-16	-12	15,75
PG-138	35,05	-20/-24	-20/-24	-16	-16/-20	-16	-16/-20	-16		-16/-20	15,75
PG-188	47,75	-32/-40/-48	-32/-40/-48	-20/-24/-32	-24/-32		-24/-32	-20/-24/-32		-24/-32	15,75

Information about standard products or non-standard products can be found in the current price list. Dimensions shown may be changed at any time without prior notice.

WKS – Rubber Hand Grip

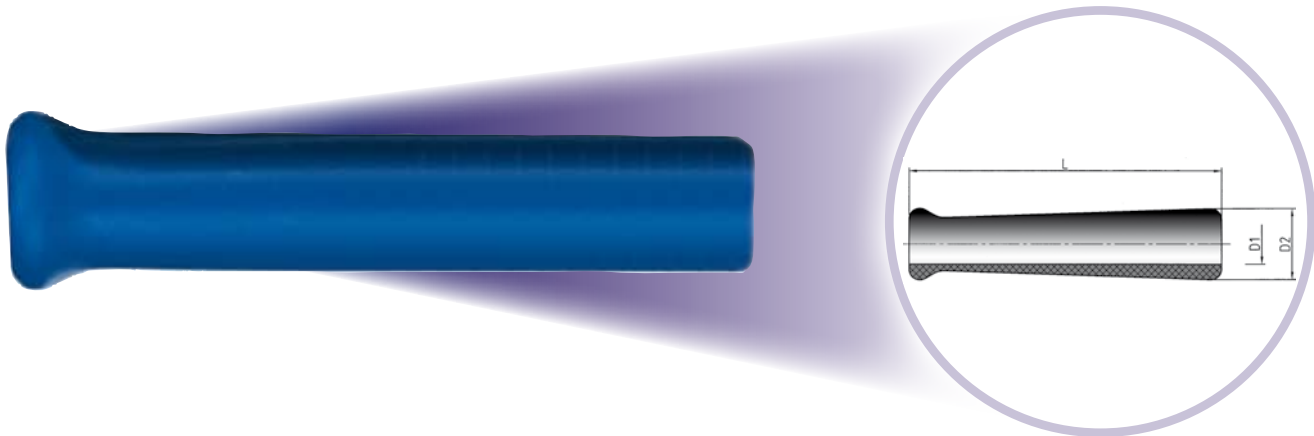
For *No-Skive* high pressure water cleaning hoses



XXXX-XX-XX Part Number	Colour	 Hose I.D.				L mm	D1 mm	D2 mm
		DN	Inch	Size	mm			
WKS-4-BLK	black	6	1/4	-4	6,3	120	15	24
WKS-4-BLU	blue	6	1/4	-4	6,3	120	15	24
WKS-5-BLK	black	8	5/16	-5	7,9	150	17	34
WKS-5-BLU	blue	8	5/16	-5	7,9	150	17	34
WKS-6-BLK	black	10	3/8	-6	9,5	150	19,5	34
WKS-6-BLU	blue	10	3/8	-6	9,5	150	19,5	34
WKS-8-BLK	black	12	1/2	-8	12,7	150	22,5	34
WKS-8-BLU	blue	12	1/2	-8	12,7	150	22,5	34
WKS-8-GRA	grey	12	1/2	-8	12,7	150	22,5	34

Information about standard products or non-standard products can be found in the current price list.
Dimensions shown may be changed at any time without prior notice.

Assembly Instruction

KarryKrimp® 1 – 82CE press

Parkrimp® fittings 26, 43, 46, 48 series size -4 bis -20 (DN 06 to DN 32)

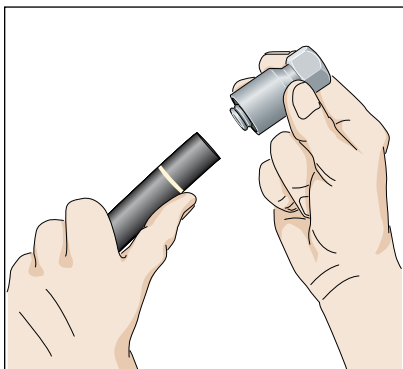

1. Push the hose all the way into the coupling. Place the hose next to the fitting shell and mark the length of the shell onto the hose – (lubricate hose end if necessary) push hose into the fitting until the mark on the hose is even with the end of the shell.

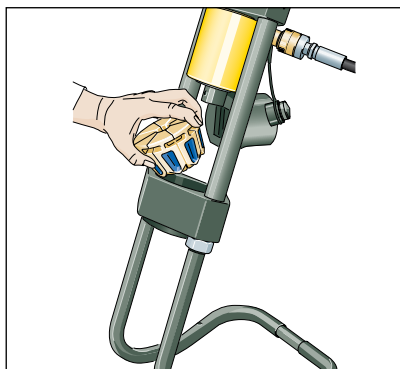

2. Pull pin and drop hinged die-train in place. Pay attention to die segment location.

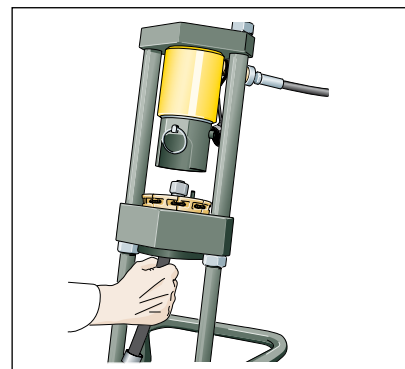

3. Insert fitting into the dies. Release, fitting will self position.



3. (a) Position the fitting on the die step.

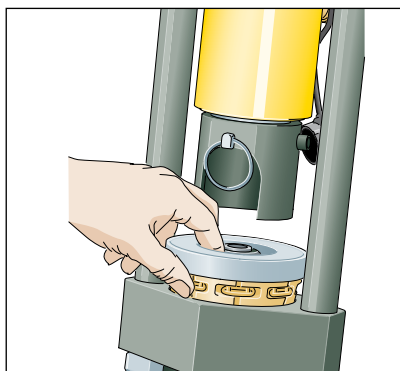

4. Place die ring on top of the dies.

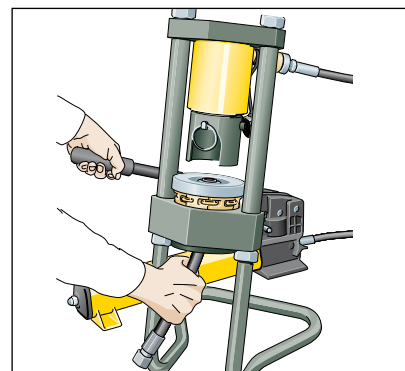

5. Position cylinder and replace pin. Pump until die ring contacts base plate.

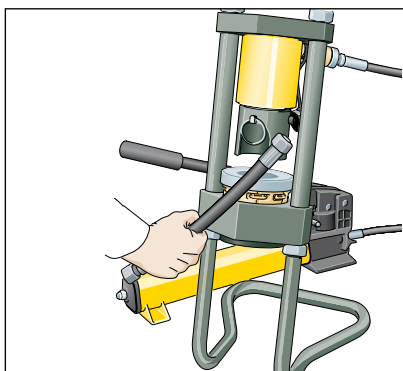

6. Release pressure – remove finished assembly.

Information about standard products or non-standard products can be found in the current price list. Dimensions shown may be changed at any time without prior notice.

Assembly Instruction

KarryKrimp® 2 – 85CE / PHastkrimp® 89CE press

Parkrimp® fittings 26, 43, 46, 48, 71, 73 and 78 series

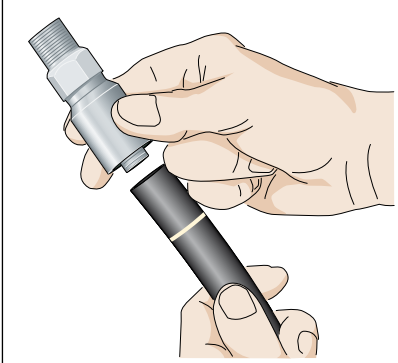

1. Push the hose all the way into the coupling. Place the hose next to the fitting shell and mark the length of the shell onto the hose – (lubricate hose end if necessary) push hose into the fitting until the mark on the hose is even with the end of the shell.

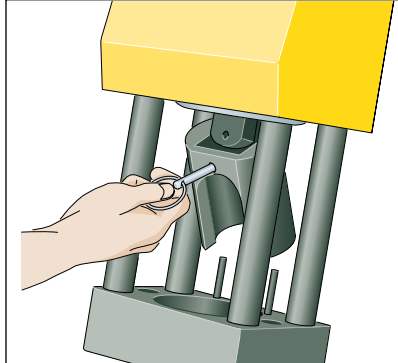

2. Pull pin to swing pusher back.

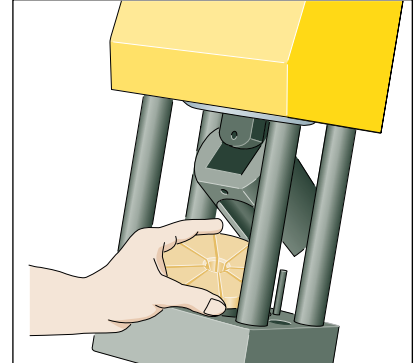

3. Drop unitised die set in place. Note: die sets are colour coded by size. Pay attention to die segment location.

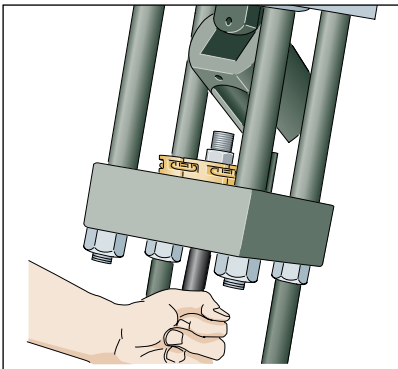

4. Insert fitting into the die; fitting will self position.



4. (a) Position the fitting on the die step.

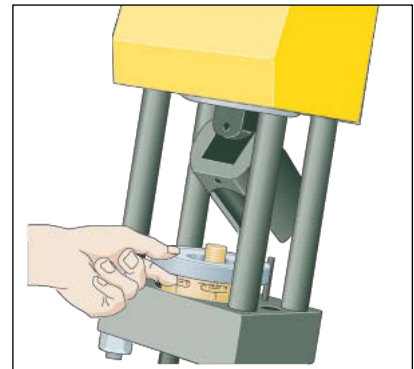

5. Place die ring on top of the dies – see decal on crimper for proper die ring. Silver: One wire braid Black: Two wire braid

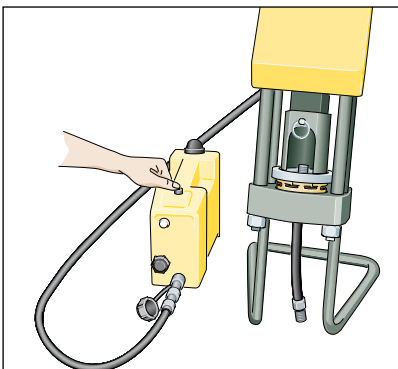

6. Position cylinder and operate pump until die ring contacts base place.

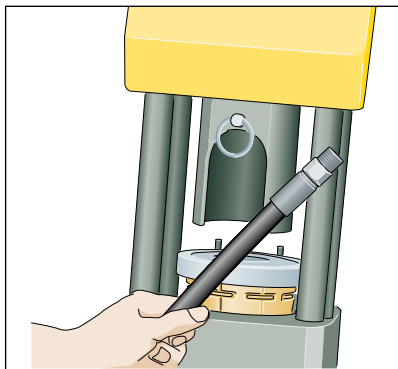

7. Release pressure – remove finished assembly.

Information about standard products or non-standard products can be found in the current price list. Dimensions shown may be changed at any time without prior notice.

Assembly Instruction

Parkrimp® 2 – 83CE

Fittings 26, 43, 70, 71, 73, 78, 79 and S6 series size -4 to -32 (DN 06 to DN 50)

For one piece die sets 80C- ... and 83C- ... size -4 to -16

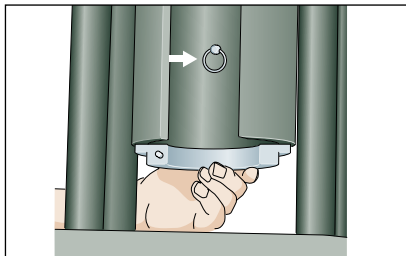

With the pusher in the full up position, lift the back half of the split die ring. Lock it in the up position by pushing the slide pin in (the slide pin is located inside the pusher at the back).

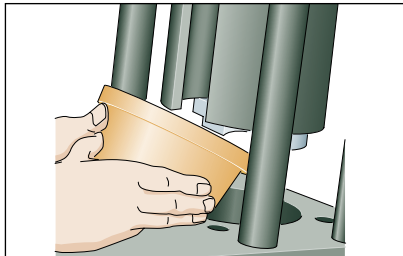

Carefully insert the adapter bowl into the base bowl. The adapter bowl must be tilted toward the back of the crimper during insertion.

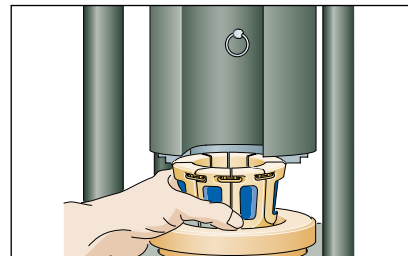

Insert the proper size and series die set into the adapter bowl.

Note: die sets are colour coded by size and have the fitting series and dash size stamped on the top. Pay attention to die segment location.

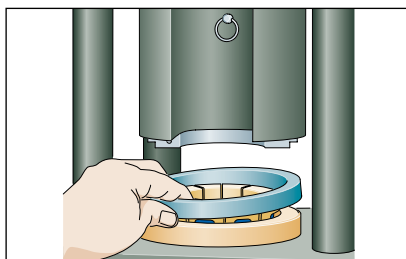

When swaging 43 series fittings on 100R2, 100R3, 100R4 and 100R9 type hose, the black spacer ring must be placed.

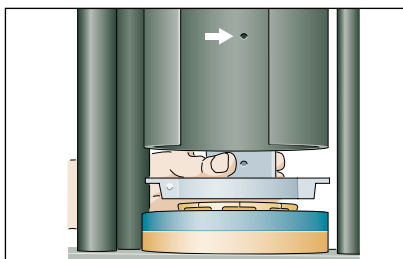

Lower the back half of the split die ring onto the dies by pulling the slide pin forward.



Insert the front half of the split die ring aligning the pin in the half with the hole in the front half.

For two piece die sets 83C-... size -20 to -32

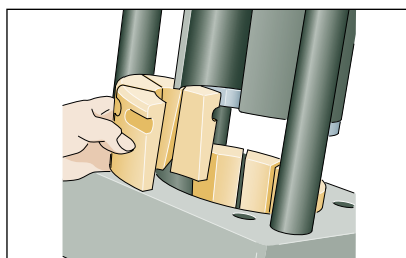

Insert the proper size die set into the die bowl (the die sets are in two halves of four dies each; Place one half in the back and one half in the front to facilitate removal of bent tube fittings).

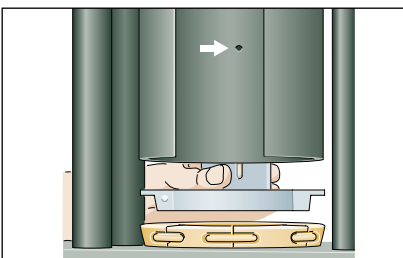

Lower the back half of the split die ring onto the dies by pulling the slide pin forward.

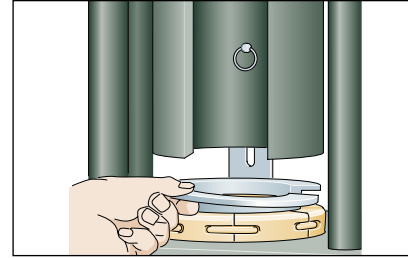

Insert the front half of the split die ring aligning the pin in the half with the hole in the front half.



Parkalign® feature
Position hose from below in dies.
Rest bottom of coupling on die step.

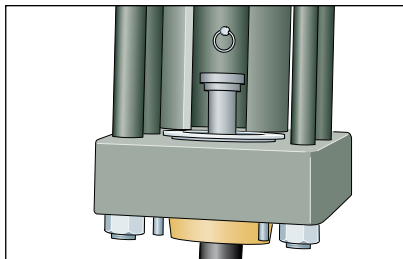

Turn on the pump by pressing the button on the left hand switch box. Lower the pusher by pressing the lower button on the right hand switch box. When the die ring contacts the base plate, the swaging is complete.

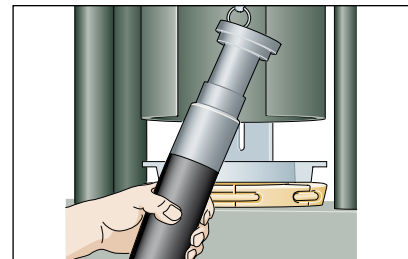

Push the black button at the top of the switch box to open dies and remove the finished assembly.

You do not have to remove any tooling to remove or insert straight fittings. The front half of the split die ring and the front die train must be removed to insert and remove bent tube fittings.

Information about standard products or non-standard products can be found in the current price list. Dimensions shown may be changed at any time without prior notice.

MiniKrimp®

26 Series

 Hose I.D.. mm Size Inch			 Hose Type	 Fitting Series	 Die Set	 Die Ring R01 silver R02 black	
5,0	-4	3/16	213-225-285-293	26	80C-E04	X	
5,0	-4	3/16	<i>201-206-266</i>	26	80C-E04		X
6,3	-5	1/4	213-221FR-225	26	80C-E05	X	
6,3	-5	1/4	<i>201-206-266</i>	26	80C-E05		X
8,0	-6	5/16	213-221FR-225-285-293	26	80C-E06	X	
8,0	-6	5/16	<i>201-206-266</i>	26	80C-E06		X
10,0	-8	13/32	213-221FR-225-285-293	26	80C-E08	X	
10,0	-8	13/32	<i>201-206-266</i>	26	80C-E08		X
12,5	-10	1/2	213-221FR-225-285-293	26	80C-E10	X	
12,5	-10	1/2	<i>201-206-266</i>	26	80C-E10		X
16,0	-12	5/8	213-221FR-225-285-293	26	80C-E12	X	
16,0	-12	5/8	<i>201-206-266</i>	26	80C-E12		X
22,0	-16	7/8	213-221FR-225-293	26	80C-E16	X	
22,0	-16	7/8	<i>201-206-235-266</i>	26	80C-E16		X

MiniKrimp is not suitable for crimping stainless steel fittings.

Dimensions shown may be changed at any time without prior notice. These crimping tables are intended as a guide. Before crimping hoses and fittings it must be assured that you have the most recent crimping dimensions. Please contact your local Parker sales office or HPDE@Parker.com
 Hose types in *italic* will no longer be produced. Crimp Charts Status: 2007-06-06

MiniKrimp®

46 Series / 48 Series

Hose I.D.				Hose Type	Fitting Series	Die Set	Die Ring		Insert depth mm	Crimp diameter	
DN	Inch	Size	mm				R01 silver	R02 black		mm	mm
6	1/4	-4	6,3	<i>491-492-492ST-691-692</i>	46	80C-B04	X		23	14,35	14,85
6	1/4	-4	6,3	441-441RH-461-461LT-462-462ST	46	80C-B04		X	23	15,35	15,85
8	5/16	-5	7,9	<i>491-492-492ST-691-692</i>	46	80C-B05	X		23	16,15	16,65
8	5/16	-5	7,9	441-441RH-461-461LT-462-462ST-463	46	80C-B05		X	23	17,15	17,65
10	3/8	-6	9,5	<i>491-492-492ST-691-692</i>	46	80C-B06	X		22	19,30	19,80
10	3/8	-6	9,5	441-441RH-461-461LT-462-462ST-463	46	80C-B06		X	22	20,35	20,85
12	1/2	-8	12,7	<i>491-492-492ST</i>	46	80C-B08	X		23	22,35	22,85
12	1/2	-8	12,7	441-441RH-461-461LT-462-462ST-463-691-692	46	80C-B08		X	23	23,35	23,85
16	5/8	-10	15,9	<i>491-492-492ST</i>	46	80C-B10	X		24	25,65	26,15
16	5/8	-10	15,9	441-441RH-461-461LT-462-462ST-691-692	46	80C-B10		X	24	26,65	27,15
20	3/4	-12	19,1	<i>491-492-492ST</i>	46	80C-B12	X		25	29,45	29,95
20	3/4	-12	19,1	441-441RH-461-461LT-462-462ST	46	80C-B12		X	25	30,50	31,00
25	1	-16	25,4	<i>491-492-492ST</i>	46	80C-B16	X		30	37,10	37,60
25	1	-16	25,4	441-441RH-461-461LT-462-462ST	46	80C-B16		X	30	38,10	38,60



Hose I.D.				Hose Type	Fitting Series	Die Set	Die Ring		Insert depth mm	Crimp diameter	
DN	Inch	Size	mm				R01 silver	R02 black		mm	mm
6	1/4	-4	6,3	<i>421-421HT-421SN-422-431-441-441RH-442-451TC-471TC-472TC-481-493</i>	48	80C-C04	X		22	16,40	16,90
6	1/4	-4	6,3	<i>301-301SN-302-304-381-421WC-601</i>	48	80C-C04		X	22	17,40	17,90
8	5/16	-5	7,9	<i>421-421SN-422-431-441-441RH-442-471TC-472TC-481-493</i>	48	80C-C05	X		24	18,05	18,55
8	5/16	-5	7,9	<i>301-301SN-302-381</i>	48	80C-C05		X	24	19,05	19,55
10	3/8	-6	9,5	<i>421-421HT-421SN-422-431-436-441-441RH-442-451-451TC-471TC-472TC-481-493</i>	48	80C-C06	X		22	20,35	20,85
10	3/8	-6	9,5	<i>301-301SN-302-381</i>	48	80C-C06		X	22	21,35	21,85
12	1/2	-8	12,7	<i>421-421HT-421SN-422-426-431-436-441-441RH-442-451-451TC-471TC-472TC-481-493</i>	48	80C-C08	X		23	23,35	23,85
12	1/2	-8	12,7	<i>301-301SN-302-381</i>	48	80C-C08		X	23	24,40	24,90
16	5/8	-10	15,9	<i>421-421HT-421SN-422-426-431-436-441-441RH-442-451-451TC-471TC-472TC-481</i>	48	80C-C10	X		25	26,65	27,15
16	5/8	-10	15,9	<i>301-301SN-302-381</i>	48	80C-C10		X	25	27,70	28,20
20	3/4	-12	19,1	<i>421-421HT-421SN-422-426-431-436-441-441RH-442-451-451TC-471TC-472TC-481</i>	48	80C-C12	X		25	30,50	31,00
20	3/4	-12	19,1	<i>301-301SN-302-381</i>	48	80C-C12		X	25	31,50	32,00
25	1	-16	25,4	<i>421-421HT-421SN-422-426-431-436-441-441RH-442-451-451TC-471TC-472TC-481</i>	48	80C-C16	X		30	38,10	38,60
25	1	-16	25,4	<i>301-301SN-302-381</i>	48	80C-C16		X	30	39,05	39,55

MiniKrimp is not suitable for crimping stainless steel fittings.

Dimensions shown may be changed at any time without prior notice. These crimping tables are intended as a guide. Before crimping hoses and fittings it must be assured that you have the most recent crimping dimensions. Please contact your local Parker sales office or HPDE@Parker.com
 Hose types in italic will no longer be produced. Crimp Charts Status: 2007-06-06

KarryKrimp® 1 / Parkrimp® 1*

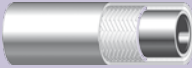
26 Series

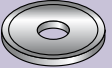
 Hose I.D..			 Hose Type	 Fitting Series	 Die Set	 Die Ring	
mm	Size	Inch				R01 silver	R02 black
5,0	-4	3/16	213-225-285-293	26	80C-E04	X	
5,0	-4	3/16	201-206-266	26	80C-E04		X
6,3	-5	1/4	213-221FR-225	26	80C-E05	X	
6,3	-5	1/4	201-206-266	26	80C-E05		X
8,0	-6	5/16	213-221FR-225-285-293	26	80C-E06	X	
8,0	-6	5/16	201-206-266	26	80C-E06		X
10,0	-8	13/32	213-221FR-225-285-293	26	80C-E08	X	
10,0	-8	13/32	201-206-266	26	80C-E08		X
12,5	-10	1/2	213-221FR-225-285-293	26	80C-E10	X	
12,5	-10	1/2	201-206-266	26	80C-E10		X
16,0	-12	5/8	213-221FR-225-285-293	26	80C-E12	X	
16,0	-12	5/8	201-206-266	26	80C-E12		X
22,0	-16	7/8	213-221FR-225-293	26	80C-E16	X	
22,0	-16	7/8	201-206-235-266	26	80C-E16		X

KarryKrimp 1 is not suitable for crimping stainless steel fittings.

* Parkrimp 1 is no more included in our delivery programme!

Dimensions shown may be changed at any time without prior notice. These crimping tables are intended as a guide. Before crimping hoses and fittings it must be assured that you have the most recent crimping dimensions. Please contact your local Parker sales office or HPDE@Parker.com
Hose types in italic will no longer be produced. Crimp Charts Status: 2007-06-06

KarryKrimp® 1 / Parkrimp® 1*

46 Series / 48 Series

Hose I.D.				Hose Type	Fitting Series	Die Set	Die Ring		Insert depth mm	Crimp diameter	
DN	Inch	Size	mm				R01 silver	R02 black		mm	mm
6	1/4	-4	6,3	<i>491-492-492ST-691-692</i>	46	80C-B04	X		23	14,35	14,85
6	1/4	-4	6,3	441-441RH-461-461LT-462-462ST	46	80C-B04		X	23	15,35	15,85
8	5/16	-5	7,9	<i>491-492-492ST-691-692</i>	46	80C-B05	X		23	16,15	16,65
8	5/16	-5	7,9	441-441RH-461-461LT-462-462ST-463	46	80C-B05		X	23	17,15	17,65
10	3/8	-6	9,5	<i>491-492-492ST-691-692</i>	46	80C-B06	X		22	19,30	19,80
10	3/8	-6	9,5	441-441RH-461-461LT-462-462ST-463	46	80C-B06		X	22	20,35	20,85
12	1/2	-8	12,7	<i>491-492-492ST</i>	46	80C-B08	X		23	22,35	22,85
12	1/2	-8	12,7	441-441RH-461-461LT-462-462ST-463-691-692	46	80C-B08		X	23	23,35	23,85
16	5/8	-10	15,9	<i>491-492-492ST</i>	46	80C-B10	X		24	25,65	26,15
16	5/8	-10	15,9	441-441RH-461-461LT-462-462ST-691-692	46	80C-B10		X	24	26,65	27,15
20	3/4	-12	19,1	<i>491-492-492ST</i>	46	80C-B12	X		25	29,45	29,95
20	3/4	-12	19,1	441-441RH-461-461LT-462-462ST	46	80C-B12		X	25	30,50	31,00
25	1	-16	25,4	<i>491-492-492ST</i>	46	80C-B16	X		30	37,10	37,60
25	1	-16	25,4	441-441RH-461-461LT-462-462ST	46	80C-B16		X	30	38,10	38,60
32	1.1/4	-20	31,8	<i>491-492-492ST</i>	46	80C-B20	X		38	43,95	44,45
32	1.1/4	-20	31,8	461-461LT-462-462ST	46	80C-B20		X	38	44,95	45,45

Hose I.D.				Hose Type	Fitting Series	Die Set	Die Ring		Insert depth mm	Crimp diameter	
DN	Inch	Size	mm				R01 silver	R02 black		mm	mm
6	1/4	-4	6,3	<i>421-421HT-421SN-422-431-441-441RH-442-451TC-471TC-472TC-481-493</i>	48	80C-C04	X		22	16,40	16,90
6	1/4	-4	6,3	<i>301-301SN-302-304-381-421WC-601</i>	48	80C-C04		X	22	17,40	17,90
8	5/16	-5	7,9	<i>421-421SN-422-431-441-441RH-442-471TC-472TC-481-493</i>	48	80C-C05	X		24	18,05	18,55
8	5/16	-5	7,9	<i>301-301SN-302-381</i>	48	80C-C05		X	24	19,05	19,55
10	3/8	-6	9,5	<i>421-421HT-421SN-422-431-436-441-441RH-442-451-451TC-471TC-472TC-481-493</i>	48	80C-C06	X		22	20,35	20,85
10	3/8	-6	9,5	<i>301-301SN-302-381</i>	48	80C-C06		X	22	21,35	21,85
12	1/2	-8	12,7	<i>421-421HT-421SN-422-426-431-436-441-441RH-442-451-451TC-471TC-472TC-481-493</i>	48	80C-C08	X		23	23,35	23,85
12	1/2	-8	12,7	<i>301-301SN-302-381</i>	48	80C-C08		X	23	24,40	24,90
16	5/8	-10	15,9	<i>421-421HT-421SN-422-426-431-436-441-441RH-442-451-451TC-471TC-472TC-481</i>	48	80C-C10	X		25	26,65	27,15
16	5/8	-10	15,9	<i>301-301SN-302-381</i>	48	80C-C10		X	25	27,70	28,20
20	3/4	-12	19,1	<i>421-421HT-421SN-422-426-431-436-441-441RH-442-451-451TC-471TC-472TC-481</i>	48	80C-C12	X		25	30,50	31,00
20	3/4	-12	19,1	<i>301-301SN-302-381</i>	48	80C-C12		X	25	31,50	32,00
25	1	-16	25,4	<i>421-421HT-421SN-422-426-431-436-441-441RH-442-451-451TC-471TC-472TC-481</i>	48	80C-C16	X		30	38,10	38,60
25	1	-16	25,4	<i>301-301SN-302-381</i>	48	80C-C16		X	30	39,05	39,55
32	1.1/4	-20	31,8	<i>421-421HT-421RH-421SN-422-426-451TC-471TC-472TC</i>	48	80C-C20	X		47	50,05	50,55
32	1.1/4	-20	31,8	<i>301-301SN-302-304-381-811-881</i>	48	80C-C20		X	47	51,05	51,55



KarryKrimp 1 is not suitable for crimping stainless steel fittings.

* Parkrimp 1 is no more included in our delivery programme!

Dimensions shown may be changed at any time without prior notice. These crimping tables are intended as a guide. Before crimping hoses and fittings it must be assured that you have the most recent crimping dimensions. Please contact your local Parker sales office or HPDE@Parker.com
Hose types in *italics* will no longer be produced. Crimp Charts Status: 2007-06-06

KarryKrimp® 2 – PHastkrimp®

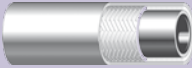
26 Series

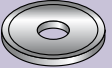
 Hose I.D..			 Hose Type	 Fitting Series	 Die Set	 Die Ring	
mm	Size	Inch				R01 silver	R02 black
5,0	-4	3/16	213-225-285-293	26	80C-E04	X	
5,0	-4	3/16	<i>201-206-266</i>	26	80C-E04		X
6,3	-5	1/4	213-221FR-225	26	80C-E05	X	
6,3	-5	1/4	<i>201-206-266</i>	26	80C-E05		X
8,0	-6	5/16	213-221FR-225-285-293	26	80C-E06	X	
8,0	-6	5/16	<i>201-206-266</i>	26	80C-E06		X
10,0	-8	13/32	213-221FR-225-285-293	26	80C-E08	X	
10,0	-8	13/32	<i>201-206-266</i>	26	80C-E08		X
12,5	-10	1/2	213-221FR-225-285-293	26	80C-E10	X	
12,5	-10	1/2	<i>201-206-266</i>	26	80C-E10		X
16,0	-12	5/8	213-221FR-225-285-293	26	80C-E12	X	
16,0	-12	5/8	<i>201-206-266</i>	26	80C-E12		X
22,0	-16	7/8	213-221FR-225-293	26	80C-E16	X	
22,0	-16	7/8	<i>201-206-235-266</i>	26	80C-E16		X

Dimensions shown may be changed at any time without prior notice. These crimping tables are intended as a guide. Before crimping hoses and fittings it must be assured that you have the most recent crimping dimensions. Please contact your local Parker sales office or HPDE@Parker.com
Hose types in italic will no longer be produced. Crimp Charts Status: 2007-06-06

KarryKrimp® 2 – PHastkrimp®

46 Series / 48 Series

Hose I.D.				Hose Type	Fitting Series	Die Set	Die Ring		Insert depth mm	Crimp diameter	
DN	Inch	Size	mm				R01 silver	R02 black		mm	mm
6	1/4	-4	6,3	<i>491-492-492ST-691-692</i>	46	80C-B04	X		23	14,35	14,85
6	1/4	-4	6,3	441-441RH-461-461LT-462-462ST	46	80C-B04		X	23	15,35	15,85
8	5/16	-5	7,9	<i>491-492-492ST-691-692</i>	46	80C-B05	X		23	16,15	16,65
8	5/16	-5	7,9	441-441RH-461-461LT-462-462ST-463	46	80C-B05		X	23	17,15	17,65
10	3/8	-6	9,5	<i>491-492-492ST-691-692</i>	46	80C-B06	X		22	19,30	19,80
10	3/8	-6	9,5	441-441RH-461-461LT-462-462ST-463	46	80C-B06		X	22	20,35	20,85
12	1/2	-8	12,7	<i>491-492-492ST</i>	46	80C-B08	X		23	22,35	22,85
12	1/2	-8	12,7	441-441RH-461-461LT-462-462ST-463-691-692	46	80C-B08		X	23	23,35	23,85
16	5/8	-10	15,9	<i>491-492-492ST</i>	46	80C-B10	X		24	25,65	26,15
16	5/8	-10	15,9	441-441RH-461-461LT-462-462ST-691-692	46	80C-B10		X	24	26,65	27,15
20	3/4	-12	19,1	<i>491-492-492ST</i>	46	80C-B12	X		25	29,45	29,95
20	3/4	-12	19,1	441-441RH-461-461LT-462-462ST	46	80C-B12		X	25	30,50	31,00
25	1	-16	25,4	<i>491-492-492ST</i>	46	80C-B16	X		30	37,10	37,60
25	1	-16	25,4	441-441RH-461-461LT-462-462ST	46	80C-B16		X	30	38,10	38,60
32	1.1/4	-20	31,8	<i>491-492-492ST</i>	46	80C-B20	X		38	43,95	44,45
32	1.1/4	-20	31,8	461-461LT-462-462ST	46	80C-B20		X	38	44,95	45,45

Hose I.D.				Hose Type	Fitting Series	Die Set	Die Ring		Insert depth mm	Crimp diameter	
DN	Inch	Size	mm				R01 silver	R02 black		mm	mm
6	1/4	-4	6,3	<i>421-421HT-421SN-422-431-441-441RH-442-451TC-471TC-472TC-481-493</i>	48	80C-C04	X		22	16,40	16,90
6	1/4	-4	6,3	301-301SN-302-304-381-421WC-601	48	80C-C04		X	22	17,40	17,90
8	5/16	-5	7,9	<i>421-421SN-422-431-441-441RH-442-471TC-472TC-481-493</i>	48	80C-C05	X		24	18,05	18,55
8	5/16	-5	7,9	301-301SN-302-381	48	80C-C05		X	24	19,05	19,55
10	3/8	-6	9,5	<i>421-421HT-421SN-422-431-436-441-441RH-442-451-451TC-471TC-472TC-481-493</i>	48	80C-C06	X		22	20,35	20,85
10	3/8	-6	9,5	301-301SN-302-381	48	80C-C06		X	22	21,35	21,85
12	1/2	-8	12,7	<i>421-421HT-421SN-422-426-431-436-441-441RH-442-451-451TC-471TC-472TC-481-493</i>	48	80C-C08	X		23	23,35	23,85
12	1/2	-8	12,7	301-301SN-302-381	48	80C-C08		X	23	24,40	24,90
16	5/8	-10	15,9	<i>421-421HT-421SN-422-426-431-436-441-441RH-442-451-451TC-471TC-472TC-481</i>	48	80C-C10	X		25	26,65	27,15
16	5/8	-10	15,9	301-301SN-302-381	48	80C-C10		X	25	27,70	28,20
20	3/4	-12	19,1	<i>421-421HT-421SN-422-426-431-436-441-441RH-442-451-451TC-471TC-472TC-481</i>	48	80C-C12	X		25	30,50	31,00
20	3/4	-12	19,1	301-301SN-302-381	48	80C-C12		X	25	31,50	32,00
25	1	-16	25,4	<i>421-421HT-421SN-422-426-431-436-441-441RH-442-451-451TC-471TC-472TC-481</i>	48	80C-C16	X		30	38,10	38,60
25	1	-16	25,4	301-301SN-302-381	48	80C-C16		X	30	39,05	39,55
32	1.1/4	-20	31,8	<i>421-421HT-421RH-421SN-422-426-451TC-471TC-472TC</i>	48	80C-C20	X		47	50,05	50,55
32	1.1/4	-20	31,8	301-301SN-302-304-381-811-881	48	80C-C20		X	47	51,05	51,55

Dimensions shown may be changed at any time without prior notice. These crimping tables are intended as a guide. Before crimping hoses and fittings it must be assured that you have the most recent crimping dimensions. Please contact your local Parker sales office or HPDE@Parker.com
 Hose types in italic will no longer be produced. Crimp Charts Status: 2007-06-06

KarryKrimp® 2 – PHastkrimp®

70, 71, 73, 78 Series





Hose I.D..				Hose Type	Fitting Series	Die Set	Die Ring		Insert depth mm	Crimp diameter		*
DN	Inch	Size	mm				R01 silver	R02 black		mm	mm	
10	3/8	-6	9,5	<i>371-371LT-372-372RH-372TC-701</i>	70	83C-D06		X	29	25,15	25,65	*
10	3/8	-6	9,5	<i>721TC-77C-772-772ST</i>	71	83C-D06	X		29	24,15	24,65	*
12	1/2	-8	12,7	<i>371-371LT-372-372RH-372TC-701</i>	70	83C-D08		X	35	28,95	29,45	*
12	1/2	-8	12,7	<i>721TC-77C-772-772ST</i>	71	83C-D08	X		35	27,95	28,45	*
16	5/8	-10	15,9	<i>371-371LT-372-372RH-372TC-701</i>	70	83C-D10		X	37	32,00	32,50	*
16	5/8	-10	15,9	<i>721TC-77C-772-772ST</i>	71	83C-D10	X		37	31,00	31,50	*
16	5/8	-10	15,9	<i>782</i>	78	80C-L10	X		47	35,30	35,80	
20	3/4	-12	19,1	<i>371-371LT-372-372RH-372TC-701</i>	70	83C-D12		X	39	35,45	35,95	*
20	3/4	-12	19,1	<i>721TC-77C-772-772ST-774</i>	71	83C-D12	X		39	34,40	34,90	*
20	3/4	-12	19,1	<i>731</i>	73	80C-L12	X		48	36,05	36,55	
20	3/4	-12	19,1	<i>781-782</i>	78	80C-L12	X		49	36,05	36,55	*
25	1	-16	25,4	<i>371-371LT-372-372RH-372TC-701</i>	70	83C-D16		X	47	44,05	44,55	*
25	1	-16	25,4	<i>721TC-77C-772-772ST-774</i>	71	83C-D16	X		47	43,05	43,55	*
25	1	-16	25,4	<i>731</i>	73	80C-L16	X		51	43,95	44,45	
25	1	-16	25,4	<i>781-782</i>	78	80C-L16	X		51	43,95	44,45	*
32	1.1/4	-20	31,8	<i>721TC-77C-772-772ST-774</i>	71	83C-D20	X		47	51,45	51,95	*

* Crimp diameters for stainless steel fittings can be up to 0,25 mm larger than for standard steel fittings.

Dimensions shown may be changed at any time without prior notice. These crimping tables are intended as a guide. Before crimping hoses and fittings it must be assured that you have the most recent crimping dimensions. Please contact your local Parker sales office or HPDE@Parker.com
Hose types in italic will no longer be produced. Crimp Charts Status: 2007-06-06

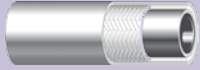
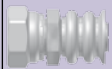
Parkrimp® 2

26 Series

 Hose I.D..			 Hose Type	 Fitting Series	 Die Set	 Die Ring 83C-R02	 Base plate 83C-R02H	 Adapter bowl 83C-OCB
mm	Size	Inch						
5,0	-4	3/16	213-225-285-293	26	80C-E04			X
5,0	-4	3/16	201-206-266	26	80C-E04	X		X
6,3	-5	1/4	213-221FR-225	26	80C-E05			X
6,3	-5	1/4	201-206-266	26	80C-E05	X		X
8,0	-6	5/16	213-221FR-225-285-293	26	80C-E06			X
8,0	-6	5/16	201-206-266	26	80C-E06	X		X
10,0	-8	13/32	213-221FR-225-285-293	26	80C-E08			X
10,0	-8	13/32	201-206-266	26	80C-E08	X		X
12,5	-10	1/2	213-221FR-225-285-293	26	80C-E10			X
12,5	-10	1/2	201-206-266	26	80C-E10	X		X
16,0	-12	5/8	213-221FR-225-285-293	26	80C-E12			X
16,0	-12	5/8	201-206-266	26	80C-E12	X		X
22,0	-16	7/8	213-221FR-225-293	26	80C-E16			X
22,0	-16	7/8	201-206-235-266	26	80C-E16	X		X
29,0	-20	1.1/8	213-225	26	83C-E20			
29,0	-20	1.1/8	201-206-266	26	83C-E20		X	
35,0	-24	1.3/8	213-225-293	26	83C-E24			
35,0	-24	1.3/8	201-206-266	26	83C-E24		X	
46,0	-32	1.13/16	213-225-293	26	83C-E32			
46,0	-32	1.13/16	201-206-266	26	83C-E32		X	

Dimensions shown may be changed at any time without prior notice. These crimping tables are intended as a guide. Before crimping hoses and fittings it must be asured that you have the most recent crimping dimensions. Please contact your local Parker sales office or HPDE@Parker.com
Hose types in italic will no longer be produced.

Crimp Charts Status: 2007-06-06

Parkrimp® 2

46 Series

Hose I.D.				Hose Type	Fitting Series	Die Set	1) 83C-R02	2) 83C-R02H	3) 83C-0CB	Insert depth mm	Crimp diameter	
DN	Inch	Size	mm								mm	mm
6	1/4	-4	6,3	<i>491-492-492ST-691-692</i>	46	80C-B04			X	23	14,35	14,85
6	1/4	-4	6,3	441-441RH-461-461LT-462-462ST	46	80C-B04	X		X	23	15,35	15,85
8	5/16	-5	7,9	<i>491-492-492ST-691-692</i>	46	80C-B05			X	23	16,15	16,65
8	5/16	-5	7,9	441-441RH-461-461LT-462-462ST-463	46	80C-B05	X		X	23	17,15	17,65
10	3/8	-6	9,5	<i>491-492-492ST-691-692</i>	46	80C-B06			X	22	19,30	19,80
10	3/8	-6	9,5	441-441RH-461-461LT-462-462ST-463	46	80C-B06	X		X	22	20,35	20,85
12	1/2	-8	12,7	<i>491-492-492ST</i>	46	80C-B08			X	23	22,35	22,85
12	1/2	-8	12,7	441-441RH-461-461LT-462-462ST-463-691-692	46	80C-B08	X		X	23	23,35	23,85
16	5/8	-10	15,9	<i>491-492-492ST</i>	46	80C-B10			X	24	25,65	26,15
16	5/8	-10	15,9	441-441RH-461-461LT-462-462ST-691-692	46	80C-B10	X		X	24	26,65	27,15
20	3/4	-12	19,1	<i>491-492-492ST</i>	46	80C-B12			X	25	29,45	29,95
20	3/4	-12	19,1	441-441RH-461-461LT-462-462ST	46	80C-B12	X		X	25	30,50	31,00
25	1	-16	25,4	<i>491-492-492ST</i>	46	80C-B16			X	30	37,10	37,60
25	1	-16	25,4	441-441RH-461-461LT-462-462ST	46	80C-B16	X		X	30	38,10	38,60
32	1.1/4	-20	31,8	<i>491-492-492ST</i>	46	80C-B20			X	38	43,95	44,45
32	1.1/4	-20	31,8	461-461LT-462-462ST	46	80C-B20	X		X	38	44,95	45,45

1) die ring; 2) base plate; 3) adapter bowl

Dimensions shown may be changed at any time without prior notice. These crimping tables are intended as a guide. Before crimping hoses and fittings it must be assured that you have the most recent crimping dimensions. Please contact your local Parker sales office or HPDE@Parker.com
Hose types in *italic* will no longer be produced. Crimp Charts Status: 2007-06-06

Parkrimp® 2

48 Series

Hose I.D.				Hose Type	Fitting Series	Die Set	1) 83C-R02	2) 83C-R02H	3) 83C-0CB	Insert depth mm	Crimp diameter	
DN	Inch	Size	mm								mm	mm
6	1/4	-4	6,3	<i>421-421HT-421SN-422-431-441-441RH-442-451TC-471TC-472TC-481-493</i>	48	80C-C04			X	22	16,40	16,90
6	1/4	-4	6,3	<i>301-301SN-302-304-381-421WC-601</i>	48	80C-C04	X		X	22	17,40	17,90
8	5/16	-5	7,9	<i>421-421SN-422-431-441-441RH-442-471TC-472TC-481-493</i>	48	80C-C05			X	24	18,05	18,55
8	5/16	-5	7,9	<i>301-301SN-302-381</i>	48	80C-C05	X		X	24	19,05	19,55
10	3/8	-6	9,5	<i>421-421HT-421SN-422-431-436-441-441RH-442-451-451TC-471TC-472TC-481-493</i>	48	80C-C06			X	22	20,35	20,85
10	3/8	-6	9,5	<i>301-301SN-302-381</i>	48	80C-C06	X		X	22	21,35	21,85
12	1/2	-8	12,7	<i>421-421HT-421SN-422-426-431-436-441-441RH-442-451-451TC-471TC-472TC-481-493</i>	48	80C-C08			X	23	23,35	23,85
12	1/2	-8	12,7	<i>301-301SN-302-381</i>	48	80C-C08	X		X	23	24,40	24,90
16	5/8	-10	15,9	<i>421-421HT-421SN-422-426-431-436-441-441RH-442-451-451TC-471TC-472TC-481</i>	48	80C-C10			X	25	26,65	27,15
16	5/8	-10	15,9	<i>301-301SN-302-381</i>	48	80C-C10	X		X	25	27,70	28,20
20	3/4	-12	19,1	<i>421-421HT-421SN-422-426-431-436-441-441RH-442-451-451TC-471TC-472TC-481</i>	48	80C-C12			X	25	30,50	31,00
20	3/4	-12	19,1	<i>301-301SN-302-381</i>	48	80C-C12	X		X	25	31,50	32,00
20	3/4	-12	19,1	811	48	80C-C12	X	X	X	25	32,50	33,00
25	1	-16	25,4	<i>421-421HT-421SN-422-426-431-436-441-441RH-442-451-451TC-471TC-472TC-481</i>	48	80C-C16			X	30	38,10	38,60
25	1	-16	25,4	<i>421-421HT-421SN-422-426-431-436-441-441RH-442-451-451TC-471TC-472TC-481</i>	48	83C-C16H				30	38,10	38,60
25	1	-16	25,4	<i>301-301SN-302-381</i>	48	80C-C16	X		X	30	39,05	39,55
25	1	-16	25,4	<i>301-301SN-302-381</i>	48	83C-C16H		X		30	39,05	39,55
25	1	-16	25,4	811	48	80C-C16	X	X	X	30	40,05	40,55
32	1.1/4	-20	31,8	<i>421-421HT-421RH-421SN-422-426-451TC-471TC-472TC</i>	48	80C-C20			X	47	50,05	50,55
32	1.1/4	-20	31,8	<i>421-421HT-421RH-421SN-422-426-451TC-471TC-472TC</i>	48	83C-C20H				47	50,05	50,55
32	1.1/4	-20	31,8	<i>301-301SN-302-304-381-811-881</i>	48	80C-C20	X		X	48	51,05	51,55
32	1.1/4	-20	31,8	<i>301-301SN-302-304-381-811-881</i>	48	83C-C20H		X		48	51,05	51,55
40	1.1/2	-24	38,1	<i>421-421HT-421RH-421SN-422-426-471TC-472TC</i>	48	83C-C24				38	58,15	58,65
40	1.1/2	-24	38,1	<i>301-301SN-302-304-381-811-881</i>	48	83C-C24		X		38	59,15	59,65
50	2	-32	50,8	<i>421-421HT-421RH-421SN-422-426-471TC-472TC</i>	48	83C-C32				48	69,45	69,95
50	2	-32	50,8	<i>301-301SN-302-304-381-811-881</i>	48	83C-C32		X		48	70,45	70,95

- 1) die ring
2) base plate
3) adapter bowl

Dimensions shown may be changed at any time without prior notice. These crimping tables are intended as a guide. Before crimping hoses and fittings it must be assured that you have the most recent crimping dimensions. Please contact your local Parker sales office or HPDE@Parker.com
Hose types in italic will no longer be produced. Crimp Charts Status: 2007-06-06

Parkrimp® 2

70, 71, 73, 78, 79, S6 Series

Hose I.D..				Hose Type	Fitting Series	Die Set	1) 83C-R02	2) 83C-R02H	3) 83C-0CB	Insert depth mm	Crimp diameter		*
DN	Inch	Size	mm								mm	mm	
10	3/8	-6	9,5	<i>371-371LT-372-372RH-372TC-701</i>	70	83C-D06	X		X	29	25,15	25,65	*
10	3/8	-6	9,5	<i>721TC-77C-772-772ST</i>	71	83C-D06			X	29	24,15	24,65	*
12	1/2	-8	12,7	<i>371-371LT-372-372RH-372TC-701</i>	70	83C-D08	X		X	35	28,95	29,45	*
12	1/2	-8	12,7	<i>721TC-77C-772-772ST</i>	71	83C-D08			X	35	27,95	28,45	*
16	5/8	-10	15,9	<i>371-371LT-372-372RH-372TC-701</i>	70	83C-D10	X		X	37	32,00	32,50	*
16	5/8	-10	15,9	<i>721TC-77C-772-772ST</i>	71	83C-D10			X	37	31,00	31,50	*
16	5/8	-10	15,9	<i>782</i>	78	80C-L10			X	47	35,30	35,80	
20	3/4	-12	19,1	<i>371-371LT-372-372RH-372TC-701</i>	70	83C-D12	X		X	39	35,45	35,95	*
20	3/4	-12	19,1	<i>721TC-77C-772-772ST-774</i>	71	83C-D12			X	39	34,40	34,90	*
20	3/4	-12	19,1	<i>731</i>	73	80C-L12			X	48	36,05	36,55	
20	3/4	-12	19,1	<i>731</i>	73	83C-L12				48	36,05	36,55	
20	3/4	-12	19,1	<i>781-782</i>	78	80C-L12			X	49	36,05	36,55	*
20	3/4	-12	19,1	<i>781-782</i>	78	83C-L12				49	36,05	36,55	*
20	3/4	-12	19,1	<i>791TC-792-792TC</i>	79	80C-L12			X	56	36,05	36,55	
20	3/4	-12	19,1	<i>791TC-792-792TC</i>	79	83C-L12				56	36,05	36,55	
25	1	-16	25,4	<i>371-371LT-372-372RH-372TC-701</i>	70	83C-D16	X		X	47	44,05	44,55	*
25	1	-16	25,4	<i>371-371LT-372-372RH-372TC-701</i>	70	83C-D16H		X		47	44,05	44,55	*
25	1	-16	25,4	<i>721TC-77C-772-772ST-774</i>	71	83C-D16			X	47	43,05	43,55	*
25	1	-16	25,4	<i>721TC-77C-772-772ST-774</i>	71	83C-D16H				47	43,05	43,55	*
25	1	-16	25,4	<i>731</i>	73	80C-L16			X	51	43,95	44,45	
25	1	-16	25,4	<i>731</i>	73	83C-L16				51	43,95	44,45	
25	1	-16	25,4	<i>781-782</i>	78	80C-L16			X	51	43,95	44,45	*
25	1	-16	25,4	<i>781-782</i>	78	83C-L16				51	43,95	44,45	*
25	1	-16	25,4	<i>791TC-792-792TC</i>	79	80C-L16			X	59	43,95	44,45	
25	1	-16	25,4	<i>791TC-792-792TC</i>	79	83C-L16				59	43,95	44,45	
32	1.1/4	-20	31,8	<i>371-701</i>	70	83C-D20H		X		47	52,45	52,95	*
32	1.1/4	-20	31,8	<i>721TC-77C-772-772ST-774</i>	71	83C-D20			X	47	51,45	51,95	*
32	1.1/4	-20	31,8	<i>721TC-77C-772-772ST-774</i>	71	83C-D20H				47	51,45	51,95	*
32	1.1/4	-20	31,8	<i>731</i>	73	83C-L20				65	54,35	54,85	
32	1.1/4	-20	31,8	<i>781-782</i>	78	83C-L20				65	54,35	54,85	*
32	1.1/4	-20	31,8	<i>791TC</i>	79	83C-L20				72	54,35	54,85	
40	1.1/2	-24	38,1	<i>701</i>	70	83C-D24		X		55	59,15	59,65	
40	1.1/2	-24	38,1	<i>711-721TC-77C-772-772ST-774</i>	71	83C-D24				60	58,15	58,65	*
40	1.1/2	-24	38,1	<i>731</i>	73	83C-L24				63	61,95	62,45	
40	1.1/2	-24	38,1	<i>781-782</i>	78	83C-L24				66	62,00	62,50	*
40	1.1/2	-24	38,1	<i>791TC</i>	79	83C-L24				76	62,00	62,50	
50	2	-32	50,8	<i>711-721TC-77C-772-772ST-774</i>	71	83C-D32				65	70,50	71,00	*
50	2	-32	50,8	<i>731</i>	73	83C-L32				73	76,85	77,35	
50	2	-32	50,8	<i>P35</i>	S6	83C-L32				88	76,85	77,35	

- 1) die ring
2) base plate
3) adapter bowl

* Crimp diameters for stainless steel fittings can be up to 0,25 mm larger than for standard steel fittings.

Dimensions shown may be changed at any time without prior notice. These crimping tables are intended as a guide. Before crimping hoses and fittings it must be asured that you have the most recent crimping dimensions. Please contact your local Parker sales office or HPDE@Parker.com
Hose types in italic will no longer be produced. Crimp Charts Status: 2007-06-06

Part Number	page	Part Number	page	Part Number	page	Part Number	page
015306	Ea-1	13773	Dd-12	19148	Cb-26	1D971	Dc-12
015307	Ea-1	13778	De-12	19226	B2b-4	1D973	Dd-8
025077-PFD	Ea-1	13926	B2b-11	19246	Cb-18	1D978	De-8
10126	B2b-8	13946	Cb-36	19248	Cb-18	1DD48	Cb-10
10146	Cb-28	13948	Cb-36	19270	Db-9	1DK46	Cb-67
10148	Cb-28	13970	Db-19	19271	Dc-9	1DK48	Cb-67
10170	Db-15	13971	Dc-17	19273	Dd-5	1DX46	Cb-68
10171	Dc-13	13973	Dd-13	19278	De-5	1DX48	Cb-68
10173	Dd-9	13978	De-13	19346	Cb-39	1EA46	Cb-22
10178	De-9	13D46	Cb-17	19348	Cb-39	1EA48	Cb-22
101S6	Dg-1	13D48	Cb-17	1B126	B2b-5	1EA70	Db-12
10346	Cb-29	13V26	B2b-10	1B146	Cb-19	1EB46	Cb-23
10348	Cb-29	13V46	Cb-35	1B148	Cb-19	1EB48	Cb-23
10370	Db-16	13V48	Cb-35	1B170	Db-10	1EC46	Cb-24
10371	Dc-14	13V70	Db-18	1B171	Dc-10	1EC48	Cb-24
10373	Dd-10	13V71	Dc-16	1B173	Dd-6	1EC70	Db-13
10378	De-10	13W26	B2b-11	1B178	De-6	1F248	Cb-55
10446	Cb-30	13W46	Cb-36	1B226	B2b-6	1F446	Cb-57
10448	Cb-30	13W48	Cb-36	1B246	Cb-20	1F448	Cb-57
10546	Cb-31	13W70	Db-19	1B248	Cb-20	1F470	Db-33
10548	Cb-31	13W71	Dc-17	1B270	Db-11	1F648	Cb-58
10626	B2b-9	13Y46	Cb-37	1B271	Dc-11	1F948	Cb-59
10646	Cb-32	13Y48	Cb-37	1B273	Dd-7	1FA48	Cb-60
10648	Cb-32	14146	Cb-37	1B278	De-7	1FG48	Cb-54
10670	Db-17	14148	Cb-37	1B446	Cb-21	1FG70	Db-32
10671	Dc-15	14926	B2b-19	1B448	Cb-21	1FU46	Cb-61
10673	Dd-11	14946	Cb-56	1B546	Cb-27	1FU48	Cb-61
10678	De-11	14948	Cb-56	1B548	Cb-27	1GU46	Cb-62
106S6	Dg-2	14A73	Dd-14	1C046	Cb-5	1GU48	Cb-62
10826	B2b-12	14A78	De-14	1C048	Cb-5	1J146	Cb-50
10846	Cb-33	14AS6	Dg-3	1C346	Cb-6	1J148	Cb-50
10848	Cb-33	14F73	Dd-15	1C348	Cb-6	1J170	Db-30
10C46	Cb-13	14F78	De-15	1C448	Cb-7	1J546	Cb-51
10C48	Cb-13	14FS6	Dg-4	1C546	Cb-8	1J548	Cb-51
10C70	Db-6	14N73	Dd-16	1C548	Cb-8	1J746	Cb-48
10C71	Dc-6	14N78	De-16	1C646	Cb-16	1J748	Cb-48
10C73	Dd-2	14NS6	Dg-5	1C648	Cb-16	1J770	Db-28
10C78	De-2	159PT26	B2b-17	1C946	Cb-12	1J771	Dc-27
10C79	Df-2	15D48	Cb-11	1C948	Cb-12	1J773	Dd-22
11546	Cb-40	15H26	B2b-15	1C970	Db-5	1J778	De-26
11548	Cb-40	15LPT26	B2b-18	1C971	Dc-5	1J779	Df-8
11570	Db-20	15S26	B2b-14	1C973	Dd-1	1J946	Cb-49
11571	Dc-18	15T26	B2b-16	1C978	De-1	1J948	Cb-49
11573	Dd-14	16826	B2b-9	1C979	Df-1	1J970	Db-29
11578	De-14	16846	Cb-32	1CA26	B2b-1	1J971	Dc-28
11671	Dc-19	16848	Cb-32	1CA46	Cb-1	1J973	Dd-23
11746	Cb-41	16870	Db-17	1CA48	Cb-1	1J978	De-27
11748	Cb-41	16871	Dc-15	1CA70	Db-1	1J979	Df-9
11770	Db-21	16A46	Cb-43	1CA71	Dc-1	1JC26	B2b-13
11771	Dc-20	16A48	Cb-43	1CE26	B2b-2	1JC46	Cb-46
11773	Dd-15	16A70	Db-23	1CE46	Cb-2	1JC48	Cb-46
11778	De-15	16A71	Dc-22	1CE48	Cb-2	1JC70	Db-26
11946	Cb-42	16A73	Dd-17	1CE70	Db-2	1JC71	Dc-25
11948	Cb-42	16A78	De-17	1CE71	Dc-2	1JC73	Dd-20
11970	Db-22	16A79	Df-4	1CF26	B2b-3	1JC78	De-24
11971	Dc-21	16AS6	Dg-6	1CF46	Cb-3	1JD46	Cb-53
11973	Dd-16	16F46	Cb-44	1CF48	Cb-3	1JD48	Cb-53
11978	De-16	16F48	Cb-44	1CF70	Db-3	1JM46	Cb-52
11C46	Cb-14	16F70	Db-24	1CF71	Dc-3	1JM48	Cb-52
11C48	Cb-14	16F71	Dc-23	1CW46	Cb-69	1JM70	Db-31
11C70	Db-7	16F73	Dd-18	1CW48	Cb-69	1JM73	Dd-24
11C71	Dc-7	16F78	De-18	1D046	Cb-4	1JM78	De-28
11C73	Dd-3	16F79	Df-5	1D048	Cb-4	1JS46	Cb-47
11C78	De-3	16FS6	Dg-7	1D070	Db-4	1JS48	Cb-47
11C79	Df-3	16N46	Cb-45	1D071	Dc-4	1JS70	Db-27
11D46	Cb-9	16N48	Cb-45	1D246	Cb-15	1JS71	Dc-26
11D48	Cb-9	16N70	Db-25	1D248	Cb-15	1JS73	Dd-21
13346	Cb-34	16N71	Dc-24	1D270	Db-8	1JS78	De-25
13348	Cb-34	16N73	Dd-19	1D271	Dc-8	1JS79	Df-7
13726	B2b-10	16N78	De-19	1D273	Dd-4	1L946	Cb-38
13746	Cb-35	16N79	Df-6	1D278	De-4	1L948	Cb-38
13748	Cb-35	16NS6	Dg-8	1D946	Cb-25	1MU46	Cb-63
13770	Db-18	19126	B2b-7	1D948	Cb-25	1MU48	Cb-63
13771	Dc-16	19146	Cb-26	1D970	Db-14	1MU70	Db-34

Part Number	page	Part Number	page	Part Number	page	Part Number	page
1MZ46	Cb-64	422	Ca-8	82CE-003	Ea-2	CARG	Eb-3
1MZ48	Cb-64	424	Ca-9	82CE-061	Ea-2	DP	B1b-36
1NW46	Cb-70	426	Ca-10	82CE-0AP	Ea-6	DR	B1b-37
1NW48	Cb-70	436	Ca-11	82CE-0EP	Ea-6	EARG	Eb-2
1PW46	Cb-71	441	Ca-12	82C-R01	Ea-2	EM10.P	Ea-8
1PW48	Cb-71	441RH	Ca-13	82C-R01-PFD	Ea-1	FHS	Eb-1
1T126	B2b-20	451TC	Ca-14	82C-R02	Ea-1	FS-F	Eb-10
1UT46	Cb-65	461LT	Ca-15	82C-R02	Ea-2	H896137	Ea-18
1UT48	Cb-65	462	Ca-16	830M	B1a-4	H899770	Ea-19
1XA78	De-20	462ST	Ca-17	831	B1a-5	H899771	Ea-17
1XF78	De-21	463	Ca-18	836	B1a-6	H899959	Ea-17
1XG78	De-22	471TC	Ca-19	837BM	B1a-7	HG	Eb-11
1XN78	De-23	472TC	Ca-19	837PU-Plus	B1a-8	Hoze-Oil	Ea-18
1XU48	Cb-66	492	Ca-20	838M	B1a-9	M	Eb-4
1XU70	Db-35	492ST	Ca-21	83C-A16H	Ea-7	M1H	Eb-1
1XU71	Dc-29	493	Ca-22	83C-A20H	Ea-7	M2H	Eb-1
1XY70	Db-36	50H	Eb-1	83C-A24	Ea-7	P35	Da-10
2-0	Eb-2	51H	Eb-1	83C-A32	Ea-7	PG	Eb-11
201	B2a-1	600.4	Ea-17	83C-C16H	Ea-7	PS	Eb-9
206	B2a-2	601	B2a-7	83C-C20H	Ea-7	S	Eb-5
213	B2a-3	611050G	Ea-18	83C-C24	Ea-7	SG	Eb-7
2-2	Eb-3	611HT	B2a-8	83C-C32	Ea-7	SS-N	Eb-5
221FR	B2a-4	681DB	B2a-9	83C-D06	Ea-7	T891179	Ea-9
285	B2a-5	692	Ca-23	83C-D06	Ea-7	T891179	Ea-10
293	B2a-6	692Twin	Ca-24	83C-D08	Ea-7	T891180	Ea-11
30182	B1b-20	701	Da-5	83C-D08	Ea-7	T905871	Ea-11
301SN	Ca-1	711509	Eb-2	83C-D10	Ea-7	TH11-3	Ea-18
302	Ca-2	721TC	Da-6	83C-D10	Ea-7	TH3-13-12V	Ea-12
30282	B1b-22	731	Da-7	83C-D12	Ea-7	TH3-13-3PH	Ea-12
30382	B1b-23	774	Da-8	83C-D12	Ea-7	TH3-13-BS	Ea-12
304	Ca-3	781	Da-9	83C-D16	Ea-7	TH3-13-BT	Ea-12
30682	B1b-24	791TC	Da-11	83C-D16	Ea-7	TH3-14-3PH	Ea-13
30882	B1b-27	792TC	Da-12	83C-D16H	Ea-7	TH3-14-BS	Ea-13
31382	B1b-21	801	B1a-1	83C-D16H	Ea-7	TH3-14-BT	Ea-13
31D82	B1b-10	804	B1a-2	83C-D20	Ea-7	TH3-15-3PH	Ea-14
33482	B1b-19	80C-A04	Ea-7	83C-D20	Ea-7	TH3-15-BAR	Ea-14
33782	B1b-25	80C-A05	Ea-7	83C-D20H	Ea-7	TH3-15-BS	Ea-14
33982	B1b-26	80C-A06	Ea-7	83C-D20H	Ea-7	TH3-15-BTF	Ea-14
33V82	B1b-25	80C-A08	Ea-7	83C-D24	Ea-7	TH3-15-BTS	Ea-14
33W82	B1b-26	80C-A10	Ea-7	83C-D24	Ea-7	TH3-2	Ea-10
34982	B1b-34	80C-A12	Ea-7	83C-D32	Ea-7	TH3-2-12VDC	Ea-9
35C82	B1b-11	80C-A16	Ea-7	83CE-083U	Ea-5	TH3-3	Ea-11
36882	B1b-24	80C-A20	Ea-7	83C-E20	Ea-7	TH4-10	Ea-15
36C82	B1b-12	80C-B04	Ea-7	83C-E24	Ea-7	TH4-4U	Ea-16
371LT	Da-1	80C-B05	Ea-7	83C-E32	Ea-7	TH4-7	Ea-15
372	Da-2	80C-B06	Ea-7	83CE-380U	Ea-5	TH4-8	Ea-15
372RH	Da-3	80C-B08	Ea-7	83C-L12	Ea-7	TH4-9	Ea-15
372TC	Da-4	80C-B10	Ea-7	83C-L16	Ea-7	TH4-9-1	Ea-15
37C82	B1b-13	80C-B12	Ea-7	83C-L20	Ea-7	TH5-3	Ea-19
38282	B1b-35	80C-B16	Ea-7	83C-L24	Ea-7	TH5-3E	Ea-19
39182	B1b-18	80C-B20	Ea-7	83C-L32	Ea-7	TH6-6	Ea-17
39282	B1b-14	80C-C04	Ea-7	83C-L32	Ea-7	TH6-7	Ea-17
39B82	B1b-4	80C-C05	Ea-7	83C-U12	Ea-7	TH6-7-30	Ea-17
39C82	B1b-5	80C-C06	Ea-7	83C-U12	Ea-7	TH6-7-55	Ea-17
3AF82	B1b-30	80C-C08	Ea-7	83C-U16	Ea-7	TH7-12	Ea-20
3B182	B1b-15	80C-C10	Ea-7	83C-U16	Ea-7	TH7-13	Ea-20
3B282	B1b-16	80C-C12	Ea-7	853009	Eb-6	TH7-14	Ea-21
3C382	B1b-1	80C-C16	Ea-7	85C-061	Ea-3	TH7-15	Ea-21
3C482	B1b-2	80C-C20	Ea-7	85C-0AP	Ea-6	TM160x2.5x20	Ea-8
3C582	B1b-3	80C-E04	Ea-7	85CE-003	Ea-3	UPTH-22b	Ea-16
3CA82	B1b-6	80C-E05	Ea-7	85CE-061	Ea-3	UPTH-PW 11	Ea-16
3CE82	B1b-7	80C-E06	Ea-7	85CE-0HP	Ea-6	UPTS 100	Ea-16
3CF82	B1b-8	80C-E08	Ea-7	85C-R01	Ea-3	VERG	Eb-2
3D082	B1b-9	80C-E10	Ea-7	85C-R01	Ea-4	VURG	Eb-2
3D982	B1b-17	80C-E12	Ea-7	85C-R02	Ea-3	VW121	B1b-33
3FF82	B1b-29	80C-E16	Ea-7	85C-R02	Ea-4	WKS	Eb-12
3JC82	B1b-28	80C-L12	Ea-7	881	Ca-26	XARG	Eb-3
3NM82	B1b-31	80C-L16	Ea-7	89CE-061	Ea-4		
3YW82	B1b-32	811	Ca-25	94C-001-PFD	Ea-1		
402	Ca-4	821FR	B1a-3	94C-MKS2	Ea-1		
405.906	Ea-19	82C-00L	Ea-2	AG	Eb-8		
421RH	Ca-5	82C-00L	Ea-6	AM	Eb-6		
421SN	Ca-6	82C-061	Ea-2	AR	Eb-6		
421WC	Ca-7	82C-2HP	Ea-6	AS	Eb-9		

Parker's Motion & Control Technologies

At Parker, we're guided by a relentless drive to help our customers become more productive and achieve higher levels of profitability by engineering the best systems for their requirements. It means looking at customer applications from many angles to find new ways to create value. Whatever the motion or control technology need, Parker has the experience, breadth of product and global reach to consistently deliver. No company knows more about motion and control technology than Parker. For further information call 00800 27 27 5374



AEROSPACE

Key Markets

- Aircraft engines
- Business & general aviation
- Commercial transports
- Land-based weapons systems
- Military aircraft
- Missiles & launch vehicles
- Regional transports
- Unmanned aerial vehicles

Key Products

- Flight control systems & components
- Fluid conveyance systems
- Fluid metering delivery & atomization devices
- Fuel systems & components
- Hydraulic systems & components
- Inert nitrogen generating systems
- Pneumatic systems & components
- Wheels & brakes



CLIMATE CONTROL

Key Markets

- Agriculture
- Air conditioning
- Food, beverage & dairy
- Life sciences & medical
- Precision cooling
- Processing
- Transportation

Key Products

- CO² controls
- Electronic controllers
- Filter driers
- Hand shut-off valves
- Hose & fittings
- Pressure regulating valves
- Refrigerant distributors
- Safety relief valves
- Solenoid valves
- Thermostatic expansion valves



ELECTROMECHANICAL

Key Markets

- Aerospace
- Factory automation
- Life science & medical
- Machine tools
- Packaging machinery
- Paper machinery
- Plastics machinery & converting
- Primary metals
- Semiconductor & electronics
- Textile
- Wire & cable

Key Products

- AC/DC drives & systems
- Electric actuators, gantry robots & slides
- Electrohydraulic actuation systems
- Electromechanical actuation systems
- Human machine interface
- Linear motors
- Stepper motors, servo motors, drives & controls
- Structural extrusions



FILTRATION

Key Markets

- Food & beverage
- Industrial machinery
- Life sciences
- Marine
- Mobile equipment
- Oil & gas
- Power generation
- Process
- Transportation

Key Products

- Analytical gas generators
- Compressed air & gas filters
- Condition monitoring
- Engine air, fuel & oil filtration & systems
- Hydraulic, lubrication & coolant filters
- Process, chemical, water & microfiltration filters
- Nitrogen, hydrogen & zero air generators



FLUID & GAS HANDLING

Key Markets

- Aerospace
- Agriculture
- Bulk chemical handling
- Construction machinery
- Food & beverage
- Fuel & gas delivery
- Industrial machinery
- Mobile
- Oil & gas
- Transportation
- Welding

Key Products

- Brass fittings & valves
- Diagnostic equipment
- Fluid conveyance systems
- Industrial hose
- PTFE & PFA hose, tubing & plastic fittings
- Rubber & thermoplastic hose & couplings
- Tube fittings & adapters
- Quick disconnects



HYDRAULICS

Key Markets

- Aerospace
- Aerial lift
- Agriculture
- Construction machinery
- Forestry
- Industrial machinery
- Mining
- Oil & gas
- Power generation & energy
- Truck hydraulics

Key Products

- Diagnostic equipment
- Hydraulic cylinders & accumulators
- Hydraulic motors & pumps
- Hydraulic systems
- Hydraulic valves & controls
- Power take-offs
- Rubber & thermoplastic hose & couplings
- Tube fittings & adapters
- Quick disconnects



PNEUMATICS

Key Markets

- Aerospace
- Conveyor & material handling
- Factory automation
- Life science & medical
- Machine tools
- Packaging machinery
- Transportation & automotive

Key Products

- Air preparation
- Brass fittings & valves
- Manifolds
- Pneumatic accessories
- Pneumatic actuators & grippers
- Pneumatic valves & controls
- Quick disconnects
- Rotary actuators
- Rubber & thermoplastic hose & couplings
- Structural extrusions
- Thermoplastic tubing & fittings
- Vacuum generators, cups & sensors



PROCESS CONTROL

Key Markets

- Chemical & refining
- Food, beverage & dairy
- Medical & dental
- Microelectronics
- Oil & gas
- Power generation

Key Products

- Analytical sample conditioning products & systems
- Fluoropolymer chemical delivery fittings, valves & pumps
- High purity gas delivery fittings, valves & regulators
- Instrumentation fittings, valves & regulators
- Medium pressure fittings & valves
- Process control manifolds



SEALING & SHIELDING

Key Markets

- Aerospace
- Chemical processing
- Consumer
- Energy, oil & gas
- Fluid power
- General industrial
- Information technology
- Life sciences
- Military
- Semiconductor
- Telecommunications
- Transportation

Key Products

- Dynamic seals
- Elastomeric o-rings
- EMI shielding
- Extruded & precision-cut, fabricated elastomeric seals
- Homogeneous & inserted elastomeric shapes
- High temperature metal seals
- Metal & plastic retained composite seals
- Thermal management



ENGINEERING YOUR SUCCESS.

Sales Offices

AE – United Arab Emirates,
Abu Dhabi
Tel: +971 2 67 88 587

AR – Argentina, Buenos Aires
Tel: +54 3327 44 4129

AT – Austria, Wiener Neustadt
Tel: +43 (0)2622 23501-0

AT – Austria, Wiener Neustadt
(Eastern Europe)
Tel: +43 (0)2622 23501 970

AU – Australia, Castle Hill
Tel: +61 (0)2-9634 7777

AZ – Azerbaijan, Baku
Tel: +994 50 2233 458

BE – Belgium, Nivelles
Tel: +32 (0)67 280 900

BR – Brazil, Cachoeirinha RS
Tel: +55 51 3470 9144

BY – Belarus, Minsk
Tel: +375 17 209 9399

CA – Canada, Milton, Ontario
Tel: +1 905 693 3000

CH – Switzerland
See Germany

CN – China, Shanghai
Tel: +86 21 5031 2525

CN – China, Beijing
Tel: +86 10 6561 0520

CZ – Czech Republic, Klecany
Tel: +420 284 083 111

DE – Germany, Kaarst
Tel: +49 (0)2131 4016 0

DK – Denmark, Ballerup
Tel: +45 43 56 04 00

ES – Spain, Madrid
Tel: +34 902 33 00 01

FI – Finland, Vantaa
Tel: +358 (0)20 753 2500

FR – France,
Contamine-sur-Arve
Tel: +33 (0)4 50 25 80 25

GR – Greece, Athens
Tel: +30 210 933 6450

HK – Hong Kong
Tel: +852 2428 8008

HU – Hungary, Budapest
Tel: +36 1 220 4155

IE – Ireland, Dublin
Tel: +353 (0)1 466 6370

IN – India, Mumbai
Tel: +91 22 6513 7081-85

IT – Italy, Corsico (MI)
Tel: +39 02 45 19 21

JP – Japan, Fujisawa
Tel: +(81) 4 6635 3050

KR – South Korea, Seoul
Tel: +82 2 559 0400

KZ – Kazakhstan, Almaty
Tel: +7 3272 505 800

LV – Latvia, Riga
Tel: +371 74 52601

MX – Mexico, Apodaca
Tel: +52 81 8156 6000

MY – Malaysia, Subang Jaya
Tel: +60 3 5638 1476

NL – The Netherlands,
Oldenzaal
Tel: +31 (0)541 585 000

NO – Norway, Ski
Tel: +47 64 91 10 00

NZ – New Zealand, Mt Wellington
Tel: +64 9 574 1744

PL – Poland, Warsaw
Tel: +48 (0)22 573 24 00

PT – Portugal, Leca
da Palmeira
Tel: +351 22 999 7360

RO – Romania, Bucharest
Tel: +40 21 252 1382

RU – Russia, Moscow
Tel: +7 495 645-2156

SE – Sweden, Spånga
Tel: +46 (0)8 59 79 50 00

SG – Singapore
Tel: +65 6887 6300

SL – Slovenia, Novo Mesto
Tel: +386 7 337 6650

SK – Slovakia
See Czech Republic

TH – Thailand, Bangkok
Tel: +662 717 8140

TR – Turkey, Merter/Istanbul
Tel: +90 212 482 91 06 or 07

TW – Taiwan, Taipei
Tel: +886 2 2298 8987

UA – Ukraine, Kyiv
Tel: +380 44 494 2731

UK – United Kingdom,
Warwick
Tel: +44 (0)1926 317 878

US – USA, Cleveland
(Industrial)
Tel: +1 216 896 3000

US – USA, Lincolnshire
(Mobile)
Tel: +1 847 821 1500

US – USA, Miami
(Pan American Division)
Tel: +1 305 470 8800

VE – Venezuela, Caracas
Tel: +58 212 238 5422

ZA – South Africa,
Kempton Park
Tel: +27 (0)11 961 0700

